

ACME 48V

Φ68 Engine 48V Pendant

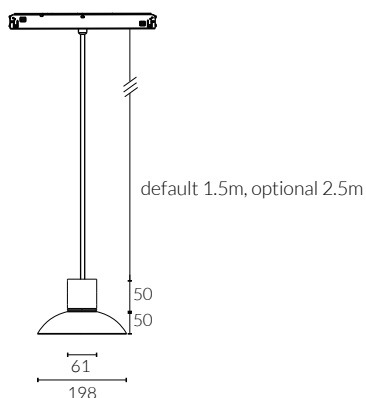

Fixed Optic



Engine



Glass

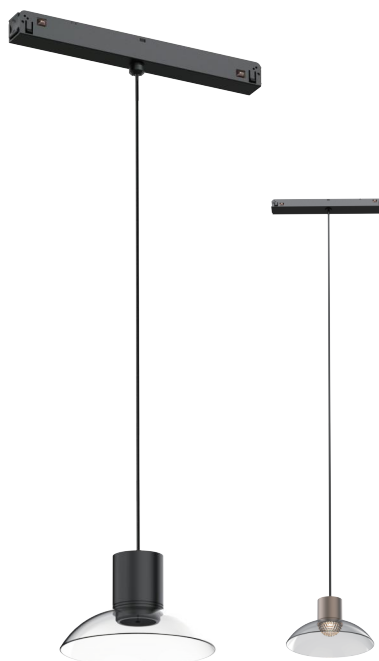

bespokable 340°
omnidirectional

IP Rating:	IP20 and IP44 options
Optics:	15°/24°/36°/50°/340°
UGR:	<10
CRI:	98Ra
Lifetime:	>50,000 hrs (L70 B10)
CCT:	2700K/3000K/3500K/4000K/5000K/ 2000K-3000K/1800K-4000K/2700K-6000K

Typical Source

Efficacy (lm/W): 110

Control: On/off, 0/1-10V, Dali, Zigbee, Casambi

Binning 2 Step MacAdams

Input: 48 VDC

Output: DC 36V 300mA 12W

Ambient temp: -20 °C to 45 °C

Class: III

Optional accessories: Honeycomb louvre, Solite Lense, Spread Lense, Colour Filter

Material: Fine aluminium 6063A, Glass

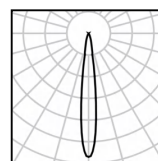

12W Ra98 3000K 15°

h(m)	E(lx)	D(m)
0.5	10897	0.17
1.0	2724	0.33
1.5	1211	0.50
2.0	681	0.66
2.5	436	0.83
3.0	303	0.99

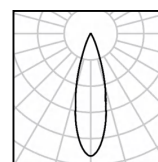

12W Ra98 3000K 24°

h(m)	E(lx)	D(m)
0.5	8621	0.20
1.0	2155	0.41
1.5	958	0.61
2.0	539	0.81
2.5	345	1.02
3.0	239	1.22

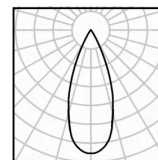

12W Ra98 3000K 36°

h(m)	E(lx)	D(m)
0.5	4792	0.28
1.0	1198	0.55
1.5	532	0.83
2.0	300	1.10
2.5	192	1.38
3.0	133	1.65

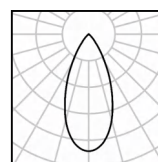

12W Ra98 3000K 50°

h(m)	E(lx)	D(m)
0.5	1608	0.47
1.0	402	0.93
1.5	179	1.40
2.0	100	1.87
2.5	64	2.33
3.0	45	2.80

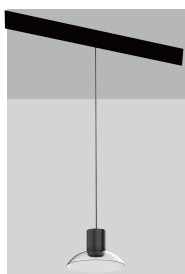
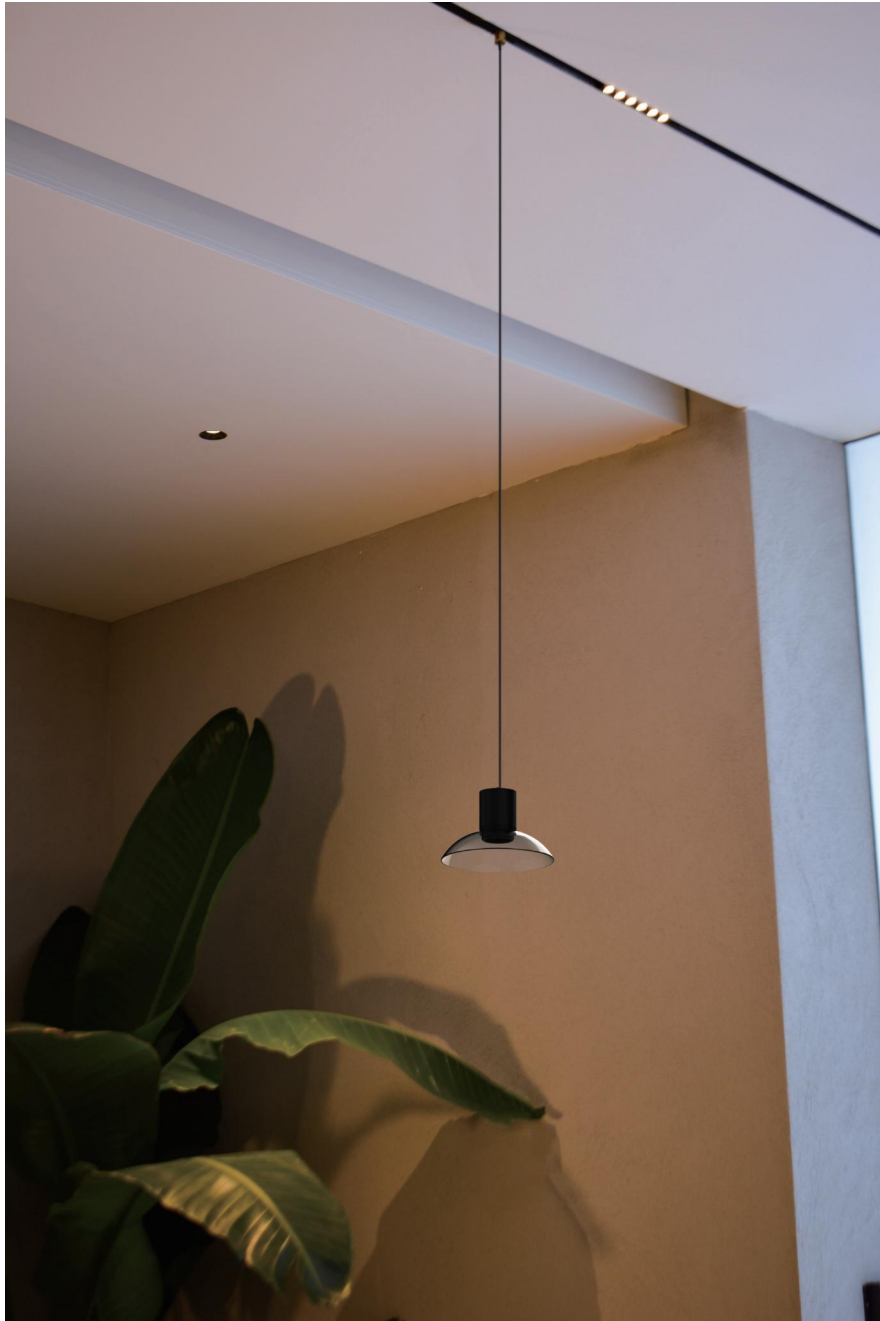

W system	lm system	optics	code
12W	717	15°	MPWGE6812W-30N15-B
12W	760	24°	MPWGE6812W-30N24-B
12W	750	36°	MPWGE6812W-30N36-B
12W	640	50°	MPWGE6812W-30N50-B
12W	650	340°	MPWGE6812W-30N340-B