

LIGHTING



DuraGreen®

DuraGreen is an innovative architectural lighting brand in the UK, specialising in crafting sustainable, miniature lighting fixtures that blend style and functionality.

Our new range of Circular - Pro lights offers groundbreaking convenience, with repairs and upgrades easier than ever.

EN_Engaging Catalogue

With our interactive digital catalogue, accessing and sharing product resources has never been easier.

ES_Catálogo Interactivo

Con nuestro catálogo digital interactivo, acceder y compartir recursos de productos nunca ha sido tan fácil.

FR_Catalogue Interactif

Avec notre catalogue numérique interactif, accéder et partager des ressources produit n'a jamais été aussi facile.

PT_Catálogo Interativo

Com o nosso catálogo digital interativo, acessar e compartilhar recursos de produtos nunca foi tão fácil.

DE_Interaktiver Katalog

Mit unserem interaktiven digitalen Katalog war der Zugriff auf Produktressourcen und deren Teilen noch nie so einfach.

TR_Etkileşimli Katalog

Etkileşimli dijital katalogumuzla, ürün kaynaklarına erişim sağlamak ve paylaşmak hiç bu kadar kolay olmamıştı.

EL_Διαδραστικός Κατάλογος

Με τον διαδραστικό ψηφιακό κατάλογό μας, η πρόσβαση και η κοινοποίηση πόρων προϊόντων δεν ήταν ποτέ πιο εύκολη.

ZH_互动目录

通过我们的互动数字目录，访问和分享产品资源从未如此简单。

JA_インタラクティブカタログ

私たちのインタラクティブなデジタルカタログを使えば、製品リソースへのアクセスや共有がこれまでにない簡単になります。

VI_Danh mục Tương tác

Với danh mục kỹ thuật số tương tác của chúng tôi, việc truy cập và chia sẻ tài nguyên sản phẩm chưa bao giờ dễ dàng hơn thế.

AR_كتالوج جذاب

مع كتالوجنا الرقمي التفاعلي، لم يكن من الأسهل من أي وقت مضى الوصول إلى موارد المنتجات ومشاركتها.

ACME STRAIGHT

Φ50 Engine Adjustable Round Downlight



cutout 50mm



Adjustable Optic



3000K



view on website

bezel | baffle

Black Painted 9025 White Painted 9015

IP Rating: IP20 and IP44 options
Optics: 15°/24°/36°
UGR: <10
CRi: 98Ra
Lifetime: >50,000 hrs (L70 B10)
CCT: 2700K/3000K/3500K/4000K/5000K/
2000K-3000K/1800K-4000K/2700K-6000K

Typical Source Efficacy (lm/W): 110
Control: On/off, Mains Dim, 0/1-10V, Dalí, Zigbee, Casambi
Binning: 2 Step/MacAdams
Input: AC220-240V 50/60Hz
Output: DC 36V 100mA 4W
DC 36V 150mA 6W
DC 36V 200mA 8W

Ambient temp: -20 °C to 45 °C
Class: II
Optional accessories: Honeycomb louvre, Solite Lens, Spread Lens.

Ceiling Thickness: 9mm-28mm
Material: Fine aluminium 6063A
Fire resistance test: 60 minutes

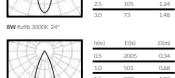
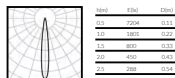

ACME STRAIGHT

Φ50 Engine Adjustable Round Downlight



cutout 50mm



Adjustable Optic



3000K

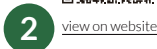

view on website

bezel | baffle

Black Painted 9025 White Painted 9015

IP Rating: IP20 and IP44 options
Optics: 15°/24°/36°
UGR: <10
CRi: 98Ra
Lifetime: >50,000 hrs (L70 B10)
CCT: 2700K/3000K/3500K/4000K/5000K/
2000K-3000K/1800K-4000K/2700K-6000K

Typical Source Efficacy (lm/W): 110
Control: On/off, Mains Dim, 0/1-10V, Dalí, Zigbee, Casambi
Binning: 2 Step/MacAdams
Input: AC220-240V 50/60Hz
Output: DC 36V 100mA 4W
DC 36V 150mA 6W
DC 36V 200mA 8W

Ambient temp: -20 °C to 45 °C
Class: II
Optional accessories: Honeycomb louvre, Solite Lens, Spread Lens.

Ceiling Thickness: 9mm-28mm
Material: Fine aluminium 6063A
Fire resistance test: 60 minutes

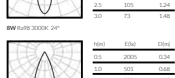
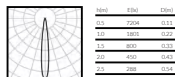

1

EN_Scan the QR code to access the product page.

ES_Escanea el código QR para acceder a la página del producto.

FR_Scanez le code QR pour accéder à la page du produit.

PT_Escaneie o código QR para acessar a página do produto.

DE_Scannen Sie den QR-Code, um zur Produktseite zu gelangen.

TR_Ürün sayfasına erişmek için QR kodunu tarayın.

EL_Σαρώστε τον κωδικό QR για να αποκτήσετε πρόσβαση στη σελίδα προϊόντος.

ZH_扫描二维码访问产品页面。

JA_QRコードをスキャンして製品ページにアクセスします。

VI_Quét mã QR để truy cập trang sản phẩm.

AR_انقر على الرابط التشعبي للوصول إلى صفحة المنتج.

2

EN_Click the hyperlink to access the product page.

ES_Haz clic en el hipervínculo para acceder a la página del producto.

FR_Cliquez sur le lien hypertexte pour accéder à la page du produit.

PT_Clique no hyperlink para acessar a página do produto.

DE_Klicken Sie auf den Hyperlink, um zur Produktseite zu gelangen.

TR_Ürün sayfasına erişmek için bağlantıya tıklayın.

EL_Κάντε κλικ στον υπερσύνδεσμο για να αποκτήσετε πρόσβαση στη σελίδα προϊόντος.

ZH_点击超链接访问产品页面。

JA_ハイパーリンクをクリックして製品ページにアクセスします。

VI_Nhấp vào liên kết để truy cập trang sản phẩm.

AR_انقر على الرابط التشعبي للوصول إلى صفحة المنتج.

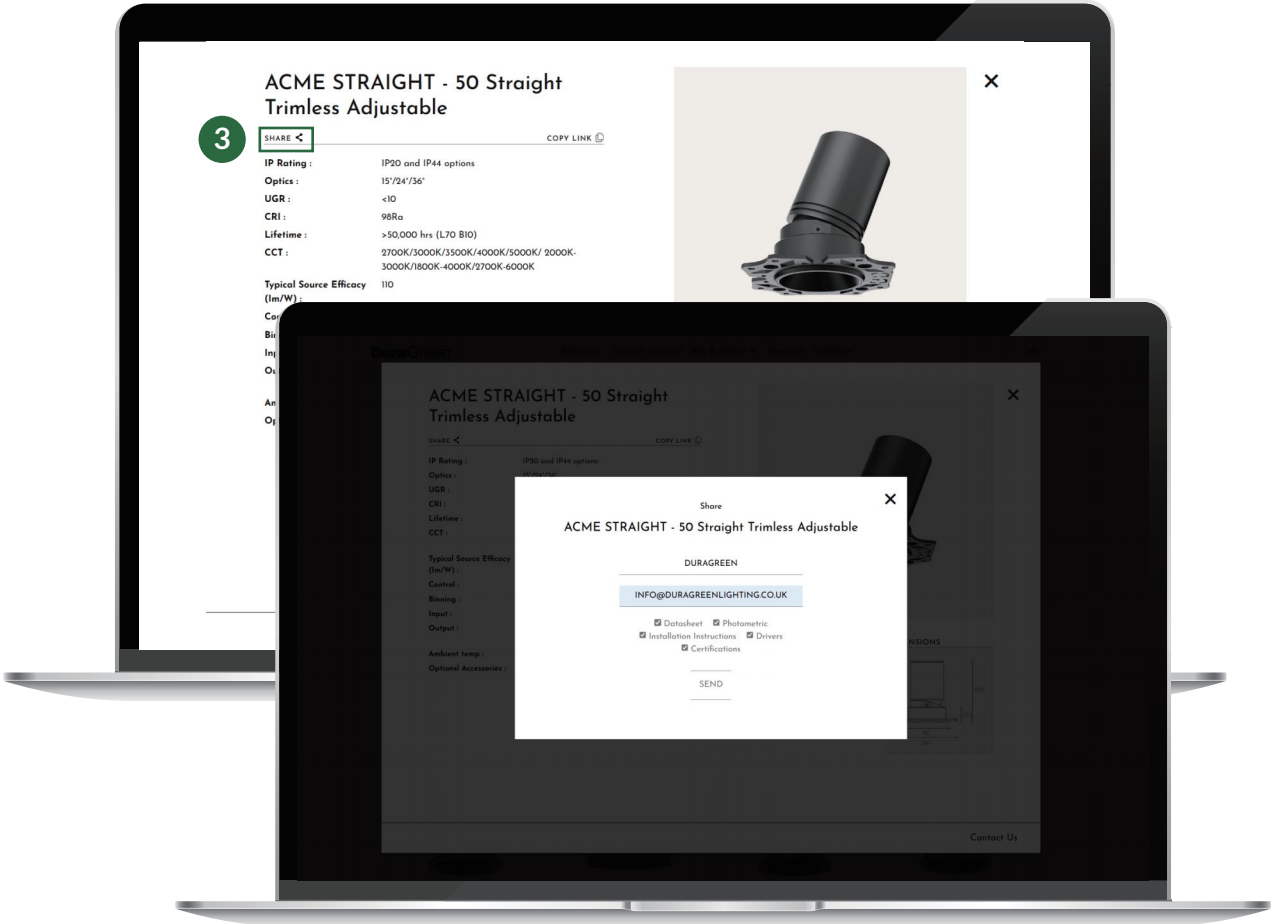

3

EN_Share the product resources by email

ES_Comparte los recursos del producto por correo electrónico.

FR_Partagez les ressources du produit par e-mail.

PT Compartilhe os recursos do produto por e-mail.

DE Teilen Sie die Produktressourcen per E-Mail.

TR Ürün kaynaklarını e-posta ile paylaşın.

EL Μοιραστείτε τους πόρους του προϊόντος μέσω email.

ZH_通过电子邮件分享产品资源。

JA_製品リソースをメールで共有します。

VI_Chia sẻ tài nguyên sản phẩm qua email.

AR_شارك موارد المنتج عبر البريد الإلكتروني.

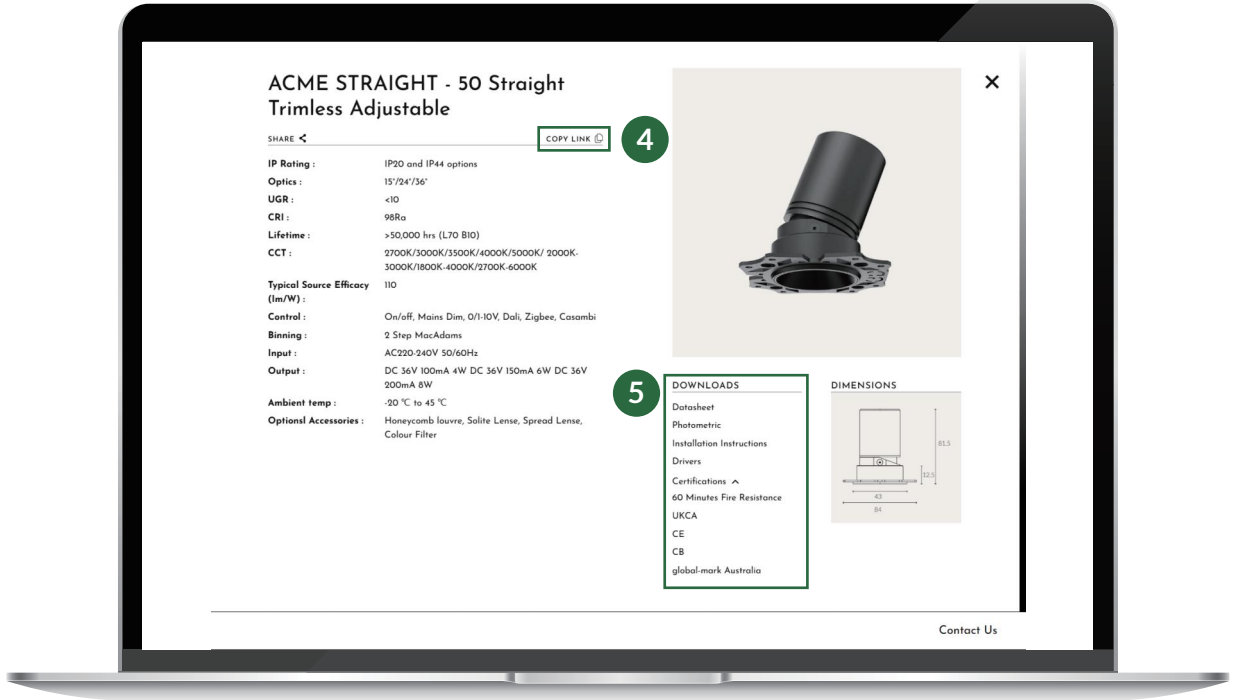

4

EN_Copy the product link and share it via instant messenger.

ES_Copia el enlace del producto y compártelo a través de un mensajero instantáneo.

FR_Copiez le lien du produit et partagez-le via un messenger instantané.

PT_Copie o link do produto e compartilhe-o via mensageiro instantâneo.

DE_Kopieren Sie den Produktlink und teilen Sie ihn über einen Instant Messenger.

TR_Ürün bağlantısını kopyalayın ve anlık mesajlaşma uygulamasıyla paylaşın.

EL_Αντιγράψτε το σύνδεσμο του προϊόντος και μοιραστείτε τον μέσω άμε σου μηνυτή.

ZH_复制产品链接并通过即时通讯工具分享。

JA_製品リンクをコピーして、インスタントメッセージで共有します。

VI_Sao chép liên kết sản phẩm và chia sẻ qua ứng dụng nhắn tin tức thì.

AR_انسخ رابط المنتج وشاركه عبر المراسلة الفورية.

5

EN_Download the product resources directly.

ES_Descarga los recursos del producto directamente.

FR_Téléchargez les ressources du produit directement.

PT_Baixe os recursos do produto diretamente.

DE_Laden Sie die Produktressourcen direkt herunter.

TR_Ürün kaynaklarını doğrudan indirin.

EL_Κατεβάστε τους πόρους του προϊόντος απευθείας.

ZH_直接下载产品资源。

JA_製品リソースを直接ダウンロードします。

VI_Tải xuống tài nguyên sản phẩm trực tiếp.

AR_قم بتنزيل موارد المنتج مباشرة.

CEILING
RECESSED

025

CEILING
SURFACE

263

SUSPENSION

311

WALL, FLOOR
& TABLE

347

TRACK
LIGHTS
48V

375

TRACK
LIGHTS
220-240V

449

LED STRIP

OUTDOOR

CONTROL

473

509

543

Bask in Luxury

Bask in Luxury

You see so much in only one day.

Saturated by light and noise, it's easy to lose sight of those small things that enrich our lives, those little differences that leave a mark.

DuraGreen specialises in crafting miniature lighting fixtures that blend style and functionality to bring out the true value of any room.

Our innovative products are small solutions that make a great change in perception, creating the luxury lifestyle you are looking for.

Circularity in Style

Our light fixtures are made of the highest quality metal materials, like pure aluminium and copper.

Our process is precise and sustainable to achieve circular products that last longer and look stylish.

British heritage

We embody British heritage with our elegant presence and exceptional craftsmanship.

We transform premium materials into fine luxury goods that elevate any space.

CEILING
RECESSED



EVOLINE
1 SPOT
P.29



EVOLINE
2 SPOTS
P.31



EVOLINE
3 SPOTS
P.33



EVOLINE
3 SPOTS
P.35

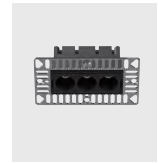

EVOLINE
3 SPOTS
P.37



EVOLINE
6 SPOTS
P.39



EVOLINE
6 SPOTS
P.41



EVOLINE
9 SPOTS
P.43



EVOLINE
9 SPOTS
P.45



ACME
STRAIGHT 36
P.53



ACME
STRAIGHT 36
P.55



ACME
STRAIGHT 50
P.57



ACME
STRAIGHT 50
P.59



ACME
PINHOLE 50
P.61



ACME
PINHOLE 50
P.63



ACME
STRAIGHT 57
P.65



ACME
STRAIGHT 57
P.67



ACME
STRAIGHT 68
P.69



ACME
STRAIGHT 68
P.71



ACME
STRAIGHT 68
P.73



ACME
STRAIGHT 68
P.75



ACME
STRAIGHT 78
P.77



ACME
STRAIGHT 78
P.79



ACME
STRAIGHT 78
P.81



ACME
STRAIGHT 78
P.83



ACME
CURVE 50
P.85



ACME
CURVE 50
P.87



ACME
CURVE 57
P.89



ACME
CURVE 57
P.91



ACME
CURVE 68
P.93



ACME
CURVE 68
P.95



ACME
CURVE 78
P.97



ACME
CURVE 78
P.99



ACME
SEMI 50
P.103



DISCONTINUED

ACME
SEMI 57
P.105

CEILING
RECESSED



ACME
SEMI 57
P.107

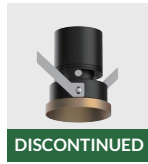

DISCONTINUED

ACME
SEMI 68
P.109



ACME
SEMI 68
P.111



DISCONTINUED

ACME
SEMI 78
P.113



ACME
SEMI 78
P.115



ACME
SQUARE 68
P.117



ACME
SQUARE 68
P.119



ACME
SQUARE 68
P.121



ACME
SQUARE 68
P.123



ACME
WALL-WASHER 68
P.125



ACME
WALL-WASHER 68
P.127



DISCONTINUED

ACME
WALL-WASHER 68
P.129



DISCONTINUED

ACME
WALL-WASHER 68
P.131



MOOD
MINI 22
P.137



MOOD
MINI 33
P.139



MOOD
MINI 40
P.141



MOOD
MINI 40
P.143



MOOD
STAR 33
P.145



MOOD
STAR 35
P.147



MOOD
DOWNLIGHT 45
P.149



MOOD
DOWNLIGHT 45
P.151



MOOD
DOWNLIGHT 55
P.153



MOOD
DOWNLIGHT 55
P.155



MOOD
DOWNLIGHT 55
P.157



MOOD
WALL-WASHER 55
P.159



MOOD
DOWNLIGHT 58
P.161



MOOD
DOWNLIGHT 75
P.163



MOOD
DOWNLIGHT 75
P.165



MOOD
WALL-WASHER 75
P.167



MOOD
DOWNLIGHT 75
P.169

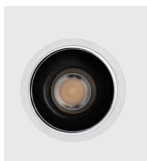

MOOD
ZOOM 75
P.171



MOOD
DOWNLIGHT 100
P.173



MOOD
DOWNLIGHT 100
P.175



MOOD
DOWNLIGHT 100
P.177



MOOD
PINHOLE
DOWNLIGHT 58
P.179

CEILING
RECESSED



MOOD
PINHOLE 58
P.181



MOOD
PINHOLE 75
P.183



MOOD
PINHOLE 75
P.185



MOOD
SQUARE 60
P.187



MOOD
SQUARE 60
P.189



MOOD
SQUARE 60
P.191

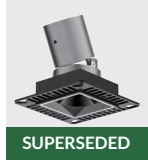

SUPERSEDED
MOOD
SQUARE 68
P.193

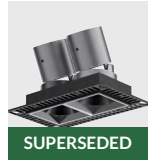

SUPERSEDED
MOOD
SQUARE 68
P.195

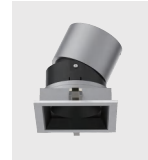

MOOD
SQUARE 80
P.197



MOOD
SQUARE 80
P.199



MOOD
SHALLOWSHINE 55
P.203



MOOD
SHALLOWSHINE 58
P.205



MOOD
SHALLOWSHINE 75
P.207



MOOD
SHALLOWSHINE 75
P.209



FLOW
LINEAR 3 SPOTS
P.213



FLOW
LINEAR 6 SPOTS
P.215



FLOW
LINEAR 9 SPOTS
P.217



FLOW
LINEAR 15 SPOTS
P.219



FLOW
LINEAR 30 SPOTS
P.221



RING
RECESSED
P.223



CUPOLA
STAR 35
P.227



CUPOLA
ZOOM 75
P.229



ACME SPY
IN-OUT 50
P.231



ACME SPY
IN-OUT 50
P.231



ACME SPY
IN-OUT 57
P.233



ACME SPY
IN-OUT 57
P.233



ACME SPY
IN-OUT 68
P.235



ACME SPY
IN-OUT 68
P.235



ACME SPY
IN-OUT 78
P.237

CEILING
RECESSED



ACME SPY
IN-OUT 78
P.237



ACME SPY
Short Snoot
P.239

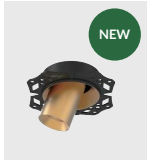

ACME SPY
Long Snoot
P.241



BELLA RECESSED
ZOOMABLE
P.243



BELLA RECESSED
ZOOMABLE
P.243



GLAMO RECESSED
ZOOMABLE
P.245



GLAMO RECESSED
ZOOMABLE
P.245



GLAMO RECESSED
CONTOUR
P.247



GLAMO RECESSED
CONTOUR
P.247



ARTFOCUS RECESSED
SPOTLIGHT 36
P.249



ARTFOCUS RECESSED
SPOTLIGHT 36
P.249



ORBIT RECESSED
SPOTLIGHT 35
P.251



ORBIT RECESSED
SPOTLIGHT 45
P.253



ORBIT RECESSED
SPOTLIGHT 55
P.255



ORBIT RECESSED
SPOTLIGHT 65
P.257



ORBIT RECESSED
CONTOUR SPOTLIGHT
P.259



ORBIT RECESSED
CONTOUR SPOTLIGHT
P.259



DIVINO RECESSED
SPOTLIGHT 35
P.261



DIVINO RECESSED
SPOTLIGHT 35
P.261

CEILING
SURFACE



EVOLINE SURFACE
9 SPOTS
P.265



ACME SURFACE
57 ENGINE
P.267



ACME SURFACE
68 ENGINE
P.269



BELLA SURFACE
ZOOMABLE
P.271



BELLA SURFACE
ZOOMABLE
P.271



BELLA SURFACE
ZOOMABLE
P.273



BELLA SURFACE
ZOOMABLE
P.273



GLAMO SURFACE
ZOOMABLE
P.275



GLAMO SURFACE
ZOOMABLE
P.275



GLAMO SURFACE
CONTOUR
P.277



ARTFOCUS SURFACE
SPOTLIGHT 36
P.279

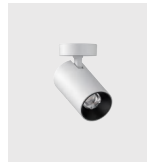

ARTFOCUS SURFACE
SPOTLIGHT 36
P.279

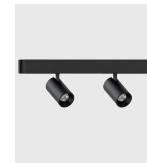

ARTFOCUS SURFACE
SPOTLIGHT 36
P.279

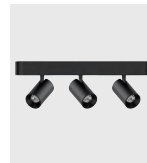

ARTFOCUS SURFACE
SPOTLIGHT 36
P.279



ORBIT SURFACE
CEILING 55
P.281

SURFACE



ORBIT SURFACE
CEILING 75
P.283



ORBIT SURFACE
CEILING 73
P.285

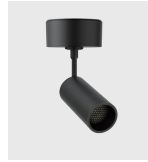

ORBIT SURFACE
SPOTLIGHT 35
P.287



ORBIT SURFACE
SPOTLIGHT 45
P.289



ORBIT SURFACE
SPOTLIGHT 55
P.291



ORBIT SURFACE
SPOTLIGHT 65
P.293



ORBIT
CONTOUR SPOTLIGHT
P.295



DIVINO
SPOTLIGHT 35
P.297



FOLD
SPOTLIGHT 45
P.299



FLOW
LINEAR 3 SPOTS
P.301



FLOW
LINEAR 5 SPOTS
P.303



FLOW
LINEAR 10 SPOTS
P.305



RING
SURFACE
P.307



BOLUX
SURFACE
P.309

SUSPENSION



ACME PENDANT
50 ENGINE
P.313



ACME PENDANT
57 ENGINE
P.315



ACME PENDANT
57 ENGINE
P.315



ACME PENDANT
68 ENGINE
P.317



ACME PENDANT
68 ENGINE
P.319



EVOLINE PENDANT
9 SPOTS
P.321



EVOLINE PENDANT
SURFACE
P.323



BELLA PENDANT
ZOOMABLE
P.325



BELLA PENDANT
ZOOMABLE 1 SPOT
P.327



BELLA PENDANT
ZOOMABLE 2 SPOTS
P.327

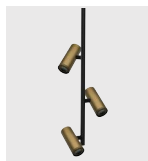

BELLA PENDANT
ZOOMABLE 3 SPOTS
P.327



GLAMO PENDANT
ZOOMABLE
P.329



ORBIT PENDANT
30 ROUND
P.331



ORBIT PENDANT
55 ROUND
P.333

SUSPENSION



ORBIT PENDANT
75
P.335

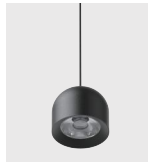

BOLUX
PENDANT 114
P.337

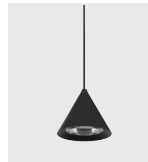

CAPRI
PENDANT 114
P.339



HALO
PENDANT 50
P.341



CONVEX
AMBER PENDANT
P.343



RING
PENDANT
P.345

WALL, FLOOR
& TABLE



ACME
MINI STEP
P.349



SPARKLE
STEP LIGHT
P.353



SPARKLE
STEP LIGHT
P.353



SPARKLE
STEP LIGHT
P.353



SPARKLE
STEP LIGHT
P.353



SPARKLE
STEP LIGHT
P.353



RIFT
STEP LIGHT
P.357



ACME
57 ENGINE WALL
P.359

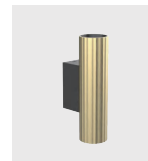

ACME
57 ENGINE WALL
P.359



ACME
68 ENGINE WALL
P.361



GLOWALL
READING LIGHT
P.363



RADIANCE
WALL SCONCE
P.365

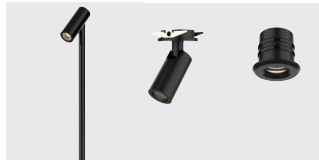

ULTRAFIN
SHOWCASE
P.369



BELLA
ZOOMABLE TABLE
P.371



BELLA
ZOOMABLE FLOOR
P.373

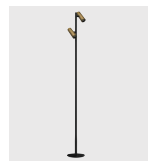

BELLA
ZOOMABLE FLOOR
P.373



BELLA
ZOOMABLE FLOOR
P.373

TRACK
LIGHTS
48V



DECO TRACK
SURFACE ROUND
P.379



DECO TRACK
SURFACE MICRO
P.380



MINI-LINE 22
SURFACE
P.381



MINI-LINE 22
TRIMLESS 12.8
P.382



ARTFOCUS 48V
SPOTLIGHT 36
P.387



ORBIT 48V
SPOTLIGHT 35
P.389



ORBIT 48V
SPOTLIGHT 45
P.391



ORBIT 48V
SPOTLIGHT 55
P.393



ORBIT 48V
SPOTLIGHT 65
P.395



ORBIT 48V
CONTOUR SPOTLIGHT
P.397



DIVINO 48V
SPOTLIGHT 35
P.399



BELLA 48V
ZOOMABLE 41
P.401



GLAMO 48V
ZOOMABLE 68
P.403



GLAMO 48V
CONTOUR SPOTLIGHT
P.405



EVOLINE 48V
DOT LINE
P.407



EVOLINE 48V
DOT LINE
P.407



EVOLINE 48V
DOT LINE
P.409



EVOLINE 48V
DOT LINE
P.409



EVOLINE 48V
DOT LINE
P.411

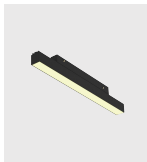

EVOLINE 48V
LIGHT STRIPE
P.413



EVOLINE 48V
LIGHT STRIPE
P.413



EVOLINE 48V
WALL WASH
P.415



GLAMO 48V
ZOOMABLE 68
P.417



EVOLINE 48V
DOWNLIGHT
P.419



BOLUX 48V
DOWNLIGHT
P.421



CAPRI 48V
DOWNLIGHT
P.441



GLAMO 48V
ZOOMABLE 68
P.423



EVOLINE 48V
9 SPOTS PENDANT
P.425



ORBIT 48V
PENDANT 30
P.427

TRACK LIGHTS
48V



ORBIT 48V
PENDANT 55
P.429



HALO 48V
PENDANT BALL
P.431



ACME 48V
PENDANT 57 Engine
P.433



ACME 48V
PENDANT 57 Engine
P.433



ACME 48V
PENDANT 68 Engine
P.435



ACME 48V
PENDANT 68 Engine
P.437



ACME 48V
PENDANT 68 Engine
P.439



ACME 48V
PENDANT 68 Engine
P.439



CAPRI 48V
PENDANT
P.441

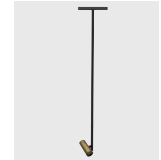

BELLA 48V
ZOOMABLE 1 SPOT
P.443



BELLA 48V
ZOOMABLE 2 SPOTS
P.443

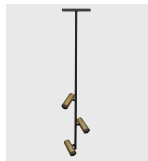

BELLA 48V
ZOOMABLE 3 SPOTS
P.443



BELLA 48V
ZOOMABLE PENDANT
P.445



EVOLINE 48V
PENDANT
P.447

TRACK LIGHTS
220-240V



TRACK 1L
SURFACE & SUSPENDED
P.452

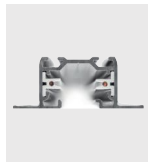

TRACK 1L
FLUSH MOUNTING
P.452

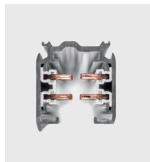

TRACK 3L
SURFACE & SUSPENDED
P.453



TRACK 3L
FLUSH MOUNTING
P.453

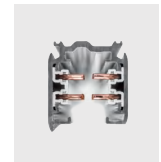

TRACK 3L DIM
SURFACE & SUSPENDED
P.454



TRACK 3L DIM
FLUSH MOUNTING
P.454



BELLA TRACK
ZOOMABLE 41
P.455



GLAMO TRACK
ZOOMABLE 68
P.457



GLAMO TRACK
CONTOUR SPOTLIGHT
P.459



ARTFOCUS TRACK
SPOTLIGHT 36
P.461



ORBIT TRACK
SPOTLIGHT 35
P.463



ORBIT TRACK
SPOTLIGHT 45
P.465



ORBIT TRACK
SPOTLIGHT 55
P.467



ORBIT TRACK
SPOTLIGHT 65
P.469



ORBIT TRACK
CONTOUR SPOTLIGHT
P.471

LINEAL



EVO-STRIP
LINEAR WALLWASH
P.477



RIGID PROFILE
P.505

LED STRIP



LINE
P.479

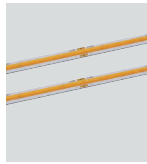

LINE COB
P.489



NEONFLEX
P.493

OUTDOOR



FOCUS OUTDOOR
UPLIGHTS 32
P.513



FOCUS OUTDOOR
UPLIGHTS 70
P.515



FOCUS OUTDOOR
UPLIGHTS 104
P.517



FOCUS OUTDOOR
UPLIGHTS 140
P.519



FOCUS OUTDOOR
SURFACE WASHER 78
P.521



FOCUS OUTDOOR
PROJECTOR
P.523



BELLA
PROJECTOR
P.525



MOOD OUTDOOR
DOWNLIGHT 55
P.527



DOME OUTDOOR
BOLLARD LIGHT
P.529



STICK OUTDOOR
BOLLARD LIGHT
P.531



ACME OUTDOOR
WALL LIGHT
P.533

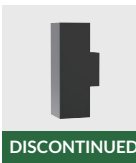

ACME OUTDOOR
WALL LIGHT
P.535



WASHFLEX
WALL GRAZER
P.537



WASHFLEX
WALL GRAZER
P.539



WASHFLEX
WALL GRAZER RGBW
P.541

CONTROL

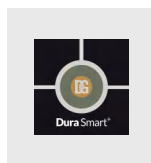

DURASMART
ZIGBEE
P.549

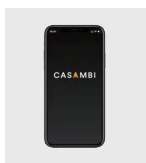

CASAMBI
P.551



DRIVERS
P.553

Our team takes great pride in offering the highest quality products to our discerning customers.

WESTIN



THE CHEDI

MELIÀ



CURIO
A COLLECTION BY HILTON™



Minotti

FENDI
CASA

Poliform

schüller

nobilicia

LAUFEN



Rimadesio

YELLOWKORNER

SAMSUNG

and more ...

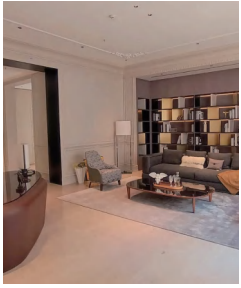

Bentley Home



VERSACE



Poliform



FENDI

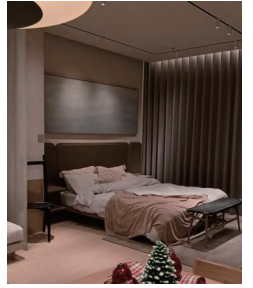

Stellar Works



HUAWEI Smart Home



Minotti



Schüller



Edra

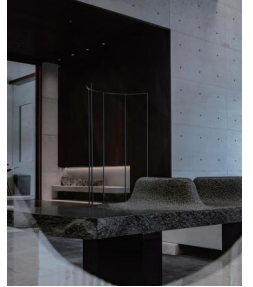

CIVRO



MESTRE

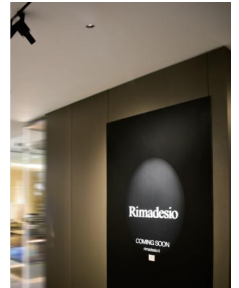

Rimadesio

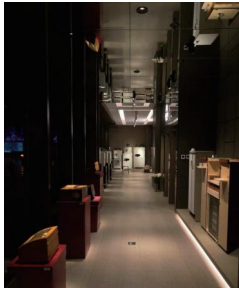

Agresti



DRAENER

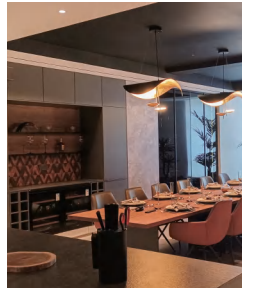

Nobilia

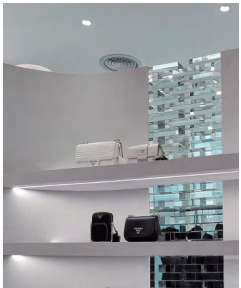

PRADA

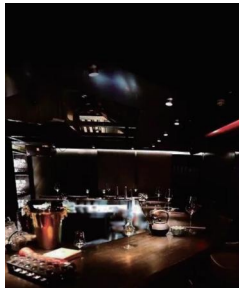

SOK Steak house



DA VITTORIO



YELLOWKORNER Art Gallery

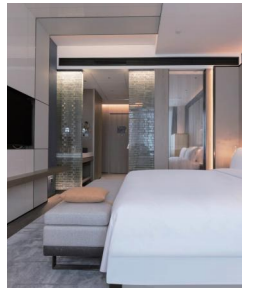

Golden Tulip Hotel

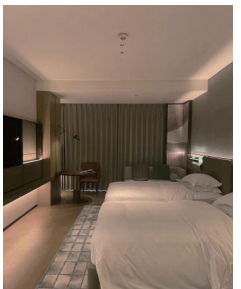

Hilton Hotel



Westin Hotel



The CHEDI Resort

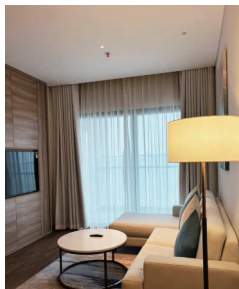

Alacarte Halong Bay Condotel

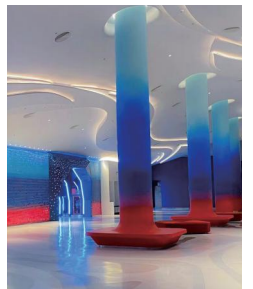

Sun Signature Show

One Plaster-in Frame | Endless Possibilities

At DuraGreen, our products embody a platform solution mindset.

Our 68mm plaster-in frame showcased in the image can seamlessly accommodate various lighting possibilities, such as downlights, wall washers, in-out spotlights, zoomable spotlights, framing lights, and even a zoomable pendant. This simplifies lighting design while enhancing the visual appeal of any space with a uniform ceiling cutout. Customers have found this feature particularly helpful for solving lighting design errors on-site.

The same platform solution is also offered with cutout sizes of 36mm, 50mm, 57mm, and 78mm. Both trim and trimless installation frame options are available.

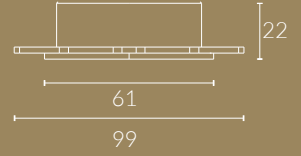

CUTOUT :68MM

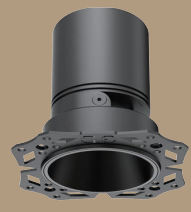

ACME STRAIGHT



ACME CURVE

ZOOMABLE 20°-50°



ACME SEMI



ACME WALL WASH



ACME IN-OUT



ZOOMABLE 20°-50°



ACME FRAMING

Think art of light

Lighting is a key element in design that greatly influences mood, emotion, and ambiance. A high-quality lighting solution has the power to elevate your designs to a whole new realm. When designing our lighting creations, we bear in mind the profound impact of light and shadow on the overall atmosphere of a space.



DuraGreen project:
2046 Black Pearl restaurant



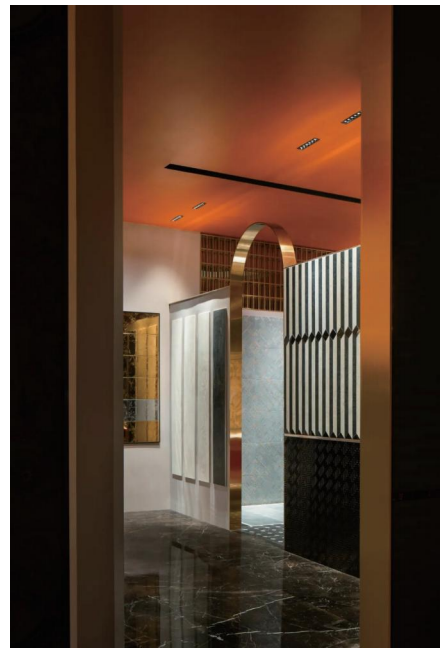

DuraGreen project:
VERSACE Showroom

Tailored Illumination

At DuraGreen, our team of skilled technicians and engineers work closely with lighting designers, architects, and interior designers throughout the entire process—from conceptualization to installation. Quality is paramount. We strive to provide the highest quality lighting fixtures that perfectly aligns with the unique needs and function of each environment, ensuring the utmost satisfaction for occupants and visitors.



Katia Saliba

Architect

Dedication to Excellence

Our steadfast commitment to design excellence and unwavering innovation ensures that we provide unrivaled solutions that not only meet, but surpass, the ever-evolving requirements of our clients.

Our dedication to excellence extends beyond our products. We pride ourselves on offering outstanding customer service, leveraging our strengths and decade of expertise to exceed our customers' expectations.



Craftsmanship

At DuraGreen, we take pride in our dedication to the art of craftsmanship. Almost all of our lighting fixtures are meticulously crafted with pure aluminium using masterful techniques, resulting in a flawless finish that exudes sophistication. Our commitment to luxurious aesthetics ensures that every product is a testament to both form and function.

DuraGreen is also renowned for its expertise in bespoke product design and manufacturing. Whether it is for a premium residential or commercial project, we are adept at creating tailor-made solutions that perfectly complement the unique requirements and vision of our clients.





Who says compact lighting can't pack a punch?

DuraGreen is breaking the mould, providing an array of compact lighting fixtures that deliver both power and comfort.

These small lights seamlessly blend cutting-edge technology, practicality, and sleek design, creating a visually stunning addition to any space.



DuraGreen project:
Schüller Showroom

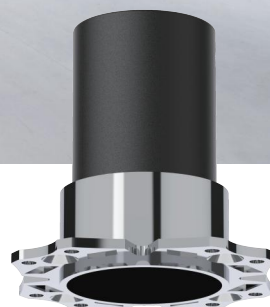

Think Small

Sustainable Future

Illuminating with purpose, we strive to bring light precisely where it is needed. By minimizing the presence of extraneous lighting fixtures, we champion resource conservation and a more sustainable path. This commitment translates into reduced power consumption, lower maintenance requirements, and decreased energy costs.

In our quest for a greener future, every product we offer proudly embodies an environmentally friendly ethos. Together, we are playing our part in safeguarding the precious world we call home. But our endeavors do not stop there. We are diligently working towards supplying luminaries, informed by the Cradle to Cradle® principles, paving the way for a circular economy. With this innovative approach, we are forging a path towards a more sustainable and environmentally conscious future.



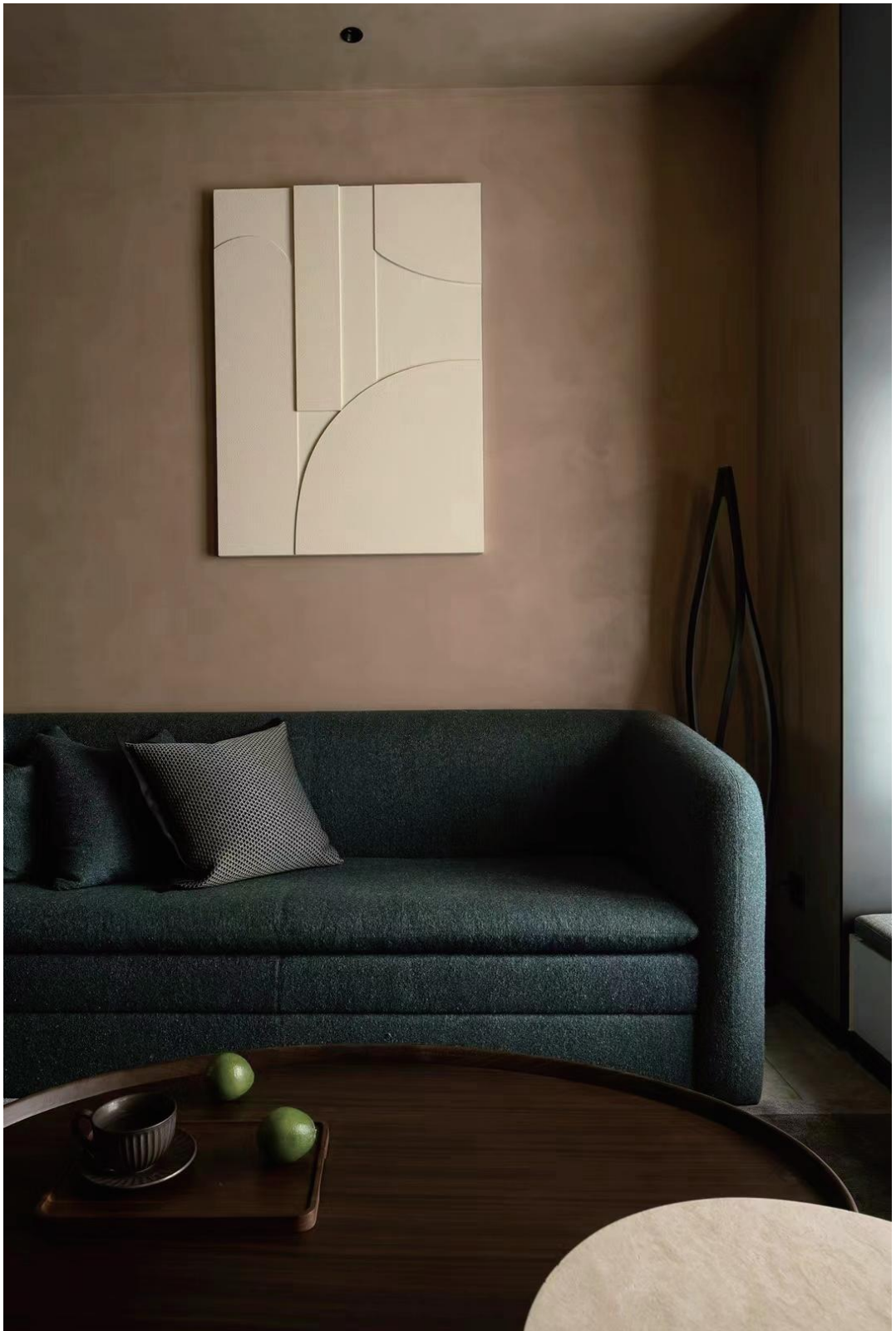

DuraGreen project:
Black Stone Hillside Hotel

Circular Product Solution

The solderless LED holder offers a convenient and streamlined approach to constructing natural white single-color or tunable white LED assemblies. By securely fastening the module to its heat sink using 2 screws and push-fit electrical connections, manual soldering of LEDs is no longer necessary. This not only protects the LED from excessive heat but also maintains a clean surface free from solder flux residue.

One notable advantage of using this holder is that it transforms light fixtures into true circular products, supporting our long-term commitment to sustainability by providing a direct and uncomplicated method for repair and reuse.

Additionally, we have incorporated holders for light lenses that adhere to Zhaga standards, an international organization in the lighting industry, which is focused on standardizing interfaces of LED lighting fixtures, including LED light engines, modules, arrays, and holders. Thanks to this, we can offer more material options for enhanced serviceability through repair and reuse.



2700K, 3000K, 3500K,
4000K, 5000K



2700 K-6500K,
1800K - 4000K Tunable White

DuraGreen's Circular Product Approach

The way companies design and manufacture products today has a direct impact on the world we will inhabit tomorrow. Merely recycling is not enough. We are paving the way for a world where all materials and products are made with tomorrow in mind.

Rooted in the Cradle to Cradle® design principles, this approach requires every step of a product's use cycle – from design and production to end-of-life – to follow a circular pathway. Today, it is possible to reshape the way we design and produce things, using innovation to drive change.

DuraGreen's products labeled with the 'circular use' sticker are designed for easy cycling and disassembly. These products include materials such as pure aluminum and solid brass while excluding plastics from their structures to increase the cycling rate for their subsequent use. Additionally, our many customer service centers (authorized distributor offices/shops) offer a rapid and convenient service for our clients, including replacing the LED chip and LED chip holder with two fixing screws and push-fit electrical connections onsite to extend the life of your lighting.

DuraGreen's 'circular use' light fittings are easily disassembled for their cycling pathway. 99% of the product's weight comprises materials compatible with the intended cycling pathway, with only the LED chip and LED chip holder requiring replacement for the next cycle of life.

DuraGreen's circular products come with:

- 10-year warranty

- Lifetime upgrading, repair, and reuse services

- End-of-life service (return unwanted light fittings to DuraGreen so they can be reintroduced into standard stock)



Lighting for better health and well-being

DuraGreen Full Spectrum LEDs

Crafted to replicate natural light, the DuraGreen full spectrum LEDs are engineered using cutting-edge chip, phosphor, and packaging technology to closely mimic the visible wavelength range of natural light. These LEDs can be effortlessly integrated into most DuraGreen lighting fixtures, bringing the beauty of full-spectrum natural light indoors and positively impacting the occupants' well-being. With high-fidelity spectral output, these LEDs provide exceptional colour rendering and superior TM30 metrics, making them ideal for a wide range of lighting applications. From retail, hospitality, office and education to museums, healthcare and residential lighting - the possibilities are limitless.

Spectral Matching to Natural Light

Average Spectral Difference (ASD)

The lighting industry is currently in the early phase of embracing human-centric lighting (HCL), which focuses on how lighting impacts the physical and emotional well-being of individuals. As humans have evolved over the millennia, our visual system has adapted to the natural light emitted by the sun and fire. These light sources have defined spectral power standards in terms of spectral power, which describe the nature of natural light. However, conventional metrics such as CCT, CRI, and TM-30 are unable to accurately qualify in accurately quantifying the naturalness or similarity of artificial light sources to these standardized natural spectra.

Bridgelux, recognizing the lack of an industry-standard metric for measuring the naturalness of light sources, has pioneered a new metric called Average Spectral Difference(ASD). This metric removes the uncertainty when comparing LED light sources to natural light. ASD is determined by assessing the absolute difference between two spectra at specific wavelengths. Natural light possesses an ASD value of 0%, indicating an exact match. Lower ASD values indicate a closer resemblance to natural light.

DuraGreen full spectrum LED is engineered to provide the closest match to natural light available using proprietary chip, phosphor, and packaging technology, resulting in an ASD between 8% to 10% for all CCTs. By comparison, standard 80, 90, and 98 CRI light sources have ASD values that are 100% to 300% larger than full spectrum LEDs.

Spectrum Characteristics

Nominal CCT	ASD	CRI	Rf	Rg	R1	R2	R3	R4	R5	R6	R7	R8	R9	R10	R11	R12	R13	R14	R15
2700K	10%	98	95	103	97	99	94	94	97	98	97	98	99	97	91	98	98	95	98
3000K	9%	98	95	104	98	99	93	94	97	98	96	96	97	96	92	95	98	95	97
3500K	8%	98	95	98	98	98	97	98	98	98	98	97	93	97	97	95	98	97	98
4000K	8%	98	97	100	99	99	97	99	99	99	99	98	94	97	99	96	99	98	98
5000K	9%	98	97	100	98	99	98	98	98	98	99	98	95	98	98	98	98	98	97
5700K	9%	98	94	98	98	98	97	95	98	97	96	95	92	97	96	96	98	98	97
6500K	8%	98	95	98	98	98	97	96	98	98	96	96	93	97	96	97	98	98	97

Performance at Commonly Used Drive Currents

CCT	CRI	Drive Current (mA)	Typical Vf Tc= 25°C (V)	Typical Efficacy Tc = 25°C (lm/W)
2700K	98	200	36.4	103
3000K	98	200	36.4	110
3500K	98	200	36.4	116
4000K	98	200	36.4	121
5000K	98	200	36.4	126
5700K	98	200	36.4	126
6500K	98	200	36.4	127

1. DuraGreen maintains a tolerance of ± 3 on Color Rendering Index , R1-R15 measurements and TM-30 measurements.
2. The data shown in the table above is for reference only. Specific values from R1 to R15 will vary for each production run.

RECESSED

EVOLINE / ACME STRAIGHT / ACME CURVE / ACME SEMI /

ACME SQUARE / ACME WALL WASHER / MOOD MINI /

MOOD STAR / MOOD DOWNLIGHT / MOOD PINHOLE /

MOOD SQUARE / MOOD SHALLOWSHINE / FLOW / RING /

CUPOLA STAR / CUPOLA ZOOM / ACME SPY / BELLA /

GLAMO / ARTFOCUS / ORBIT / DIVINO

EVOLINE

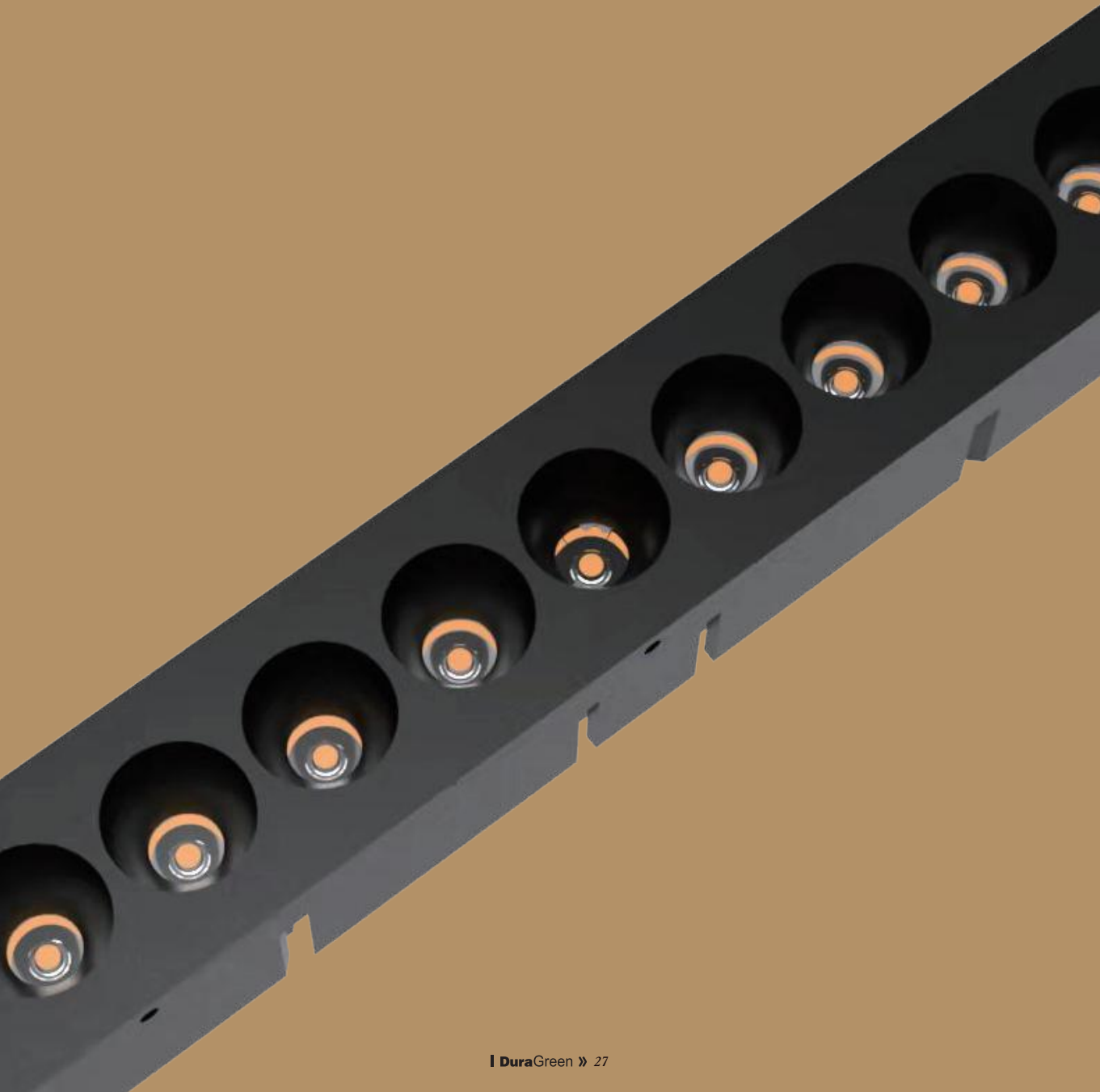

The charm of this line resides in its delicate elegance and unobtrusive nature. The refined simplicity of the fixtures' design allows them to meld seamlessly in various settings.

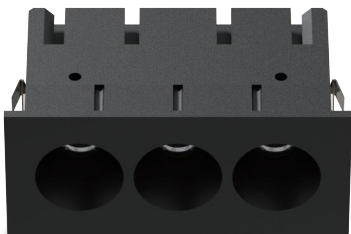

red dot winner 2023
lighting design





27X25 Recessed 1 Spot Fixed Line



cutout:27X25mm



Fixed Optic

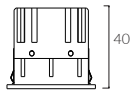
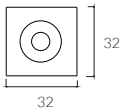

view on website

bezel | baffle



matt white painted



matt black painted

IP Rating:	IP20 and IP44 options
Optics:	14°/25°/35°
UGR:	< 10
CRI:	92Ra
Lifetime:	>50,000 hrs (L70 B10)
CCT:	3000K/3500K
Typical Source	
Efficacy (lm/W):	113
Control:	On/off, Mains Dim, 0/1-10V, Dali, Zigbee, Casambi
Binning	2 Step MacAdams
Input:	AC220-240V 50/60Hz
Output:	DC 3V 650mA 3W
Ambient temp:	-20 °C to 45 °C
Class:	II
Ceiling Thickness:	5mm-28mm
Material:	Fine aluminium 6063A

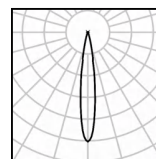

3W Ra92 3000K 14°

h(m)	E(lx)	D(m)
0.5	2760	0.13
1.0	690	0.26
1.5	307	0.38
2.0	172	0.51
2.5	110	0.64
3.0	77	0.77

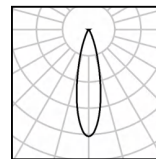

3W Ra92 3000K 25°

h(m)	E(lx)	D(m)
0.5	923	0.22
1.0	231	0.44
1.5	103	0.67
2.0	58	0.89
2.5	37	1.10
3.0	26	1.30

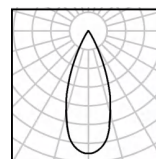

3W Ra92 3000K 35°

h(m)	E(lx)	D(m)
0.5	834	0.34
1.0	209	0.68
1.5	93	1.00
2.0	52	1.40
2.5	33	1.70
3.0	23	2.10

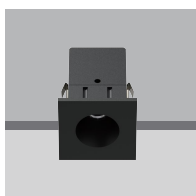

W system	lm system	optics	code
3W	138	14°	EFL0103W-30N14-B
3W	120	25°	EFL0103W-30N25-B
3W	146	35°	EFL0103W-30N35-B



reddot winner 2023
lighting design



45X25 Recessed 2 Spots Fixed Line



view on website



cutout:45X25mm



Fixed Optic

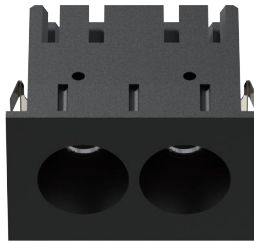
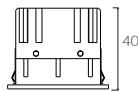
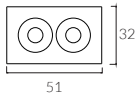

bezel | baffle



matt white painted



matt black painted

IP Rating:	IP20 and IP44 options
Optics:	14°/25°/35°
UGR:	< 10
CRI:	92Ra
Lifetime:	>50,000 hrs (L70 B10)
CCT:	3000K/3500K
Typical Source	
Efficacy (lm/W):	113
Control:	On/off, Mains Dim, 0/1-10V, Dali, Zigbee, Casambi
Binning	2 Step MacAdams
Input:	AC220-240V 50/60Hz
Output:	DC 6V 500mA 5W
Ambient temp:	-20 °C to 45 °C
Class:	II
Ceiling Thickness:	5mm-28mm
Material:	Fine aluminium 6063A

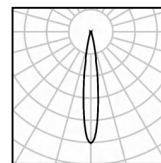

5W Ra92 3000K 14°

h(m)	E(lx)	D(m)
0.5	5014	0.13
1.0	1253	0.26
1.5	557	0.38
2.0	313	0.51
2.5	201	0.64
3.0	139	0.77

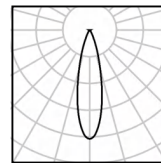

5W Ra92 3000K 25°

h(m)	E(lx)	D(m)
0.5	1914	0.24
1.0	479	0.49
1.5	213	0.73
2.0	120	0.98
2.5	77	1.22
3.0	53	1.46

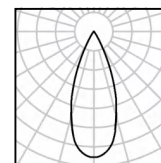

5W Ra92 3000K 35°

h(m)	E(lx)	D(m)
0.5	1006	0.29
1.0	252	0.58
1.5	112	0.88
2.0	63	1.17
2.5	40	1.46
3.0	28	1.75



DuraGreen project:
Stellar Works Home

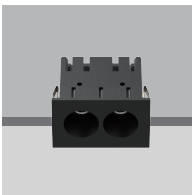

W system	lm system	optics	code
5W	240	14°	EFL0205W-30N14-B
5W	228	25°	EFL0205W-30N25-B
5W	200	35°	EFL0205W-30N35-B

EVOLINE



reddot winner 2023
lighting design



65X25 Recessed 3 Spots Fixed Line



view on website



cutout:65X25mm



Fixed Optic

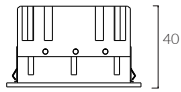
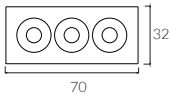
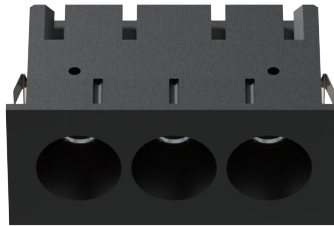

bezel | baffle



matt white painted



matt black painted

IP Rating:	IP20 and IP44 options
Optics:	14°/25°/35°
UGR:	< 10
CRI:	92Ra
Lifetime:	>50,000 hrs (L70 B10)
CCT:	3000K/3500K/2700K-6000K
Typical Source	
Efficacy (lm/W):	113
Control:	On/off, Mains Dim, 0/1-10V, Dali, Zigbee, Casambi
Binning	2 Step MacAdams
Input:	AC220-240V 50/60Hz
Output:	DC 9V 500mA 6W DC 9V 700mA 8W
Ambient temp:	-20 °C to 45 °C
Class:	II
Ceiling Thickness:	5mm-28mm
Material:	Fine aluminium 6063A

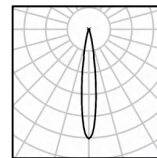

8W Ra92 3000K 14°

h(m)	E(lx)	D(m)
0.5	7614	0.14
1.0	1904	0.28
1.5	846	0.42
2.0	476	0.56
2.5	305	0.70
3.0	212	0.84

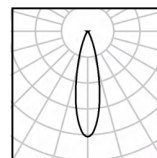

8W Ra92 3000K 25°

h(m)	E(lx)	D(m)
0.5	2824	0.25
1.0	706	0.50
1.5	314	0.75
2.0	176	1.00
2.5	113	1.26
3.0	78	1.51

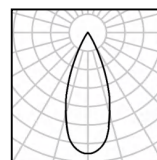

8W Ra92 3000K 35°

h(m)	E(lx)	D(m)
0.5	2277	0.31
1.0	569	0.62
1.5	253	0.92
2.0	142	1.23
2.5	91	1.54
3.0	63	1.85

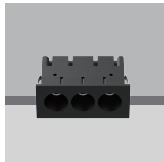

W system	lm system	optics	code
6W	305	14°	EFL0306W-30N14-B
6W	296	25°	EFL0306W-30N25-B
6W	375	35°	EFL0306W-30N35-B

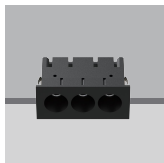

W system	lm system	optics	code
8W	377	14°	EFL0308W-30N14-B
8W	372	25°	EFL0308W-30N25-B
8W	491	35°	EFL0308W-30N35-B



reddot winner 2023
lighting design



72X40 Recessed 3 Spots Adjustable Line



view on website



CUTOUT: 72x40mm



Adjustable Optic

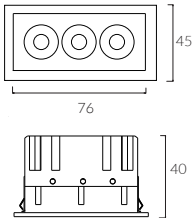
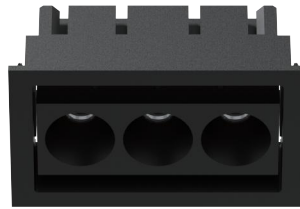

bezel | baffle



matt white painted



matt black painted

IP Rating:	IP20 and IP44 options
Optics:	14°/25°/35°
UGR:	< 10
CRI:	92Ra
Lifetime:	>50,000 hrs (L70 B10)
CCT:	3000K/3500K/2700K-6000K
Typical Source	
Efficacy (lm/W):	113
Control:	On/off, Mains Dim, 0/1-10V, Dali, Zigbee, Casambi
Binning	2 Step MacAdams
Input:	AC220-240V 50/60Hz
Output:	DC 9V 500mA 6W DC 9V 700mA 8W
Ambient temp:	-20 °C to 45 °C
Class:	II
Ceiling Thickness:	5mm-28mm
Material:	Fine aluminium 6063A

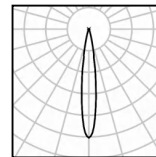

8W Ra92 3000K 14°

h(m)	E(lx)	D(m)
0.5	7614	0.14
1.0	1904	0.28
1.5	846	0.42
2.0	476	0.56
2.5	305	0.70
3.0	212	0.84

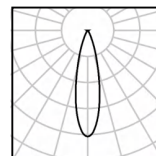

8W Ra92 3000K 25°

h(m)	E(lx)	D(m)
0.5	2824	0.25
1.0	706	0.50
1.5	314	0.75
2.0	176	1.00
2.5	113	1.26
3.0	78	1.51

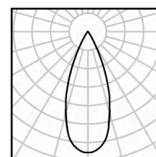

8W Ra92 3000K 35°

h(m)	E(lx)	D(m)
0.5	2277	0.31
1.0	569	0.62
1.5	253	0.92
2.0	142	1.23
2.5	91	1.54
3.0	63	1.85

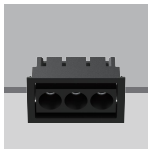

W system	lm system	optics	code
6W	305	14°	EAL0306W-30N14-B
6W	296	25°	EAL0306W-30N25-B
6W	375	35°	EAL0306W-30N35-B

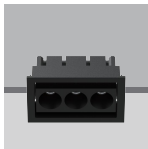

W system	lm system	optics	code
8W	377	14°	EAL0308W-30N14-B
8W	372	25°	EAL0308W-30N25-B
8W	491	35°	EAL0308W-30N35-B



74X32 Recessed 3 Spots Trimless Line



view on website



CUTOUT: 74x32mm

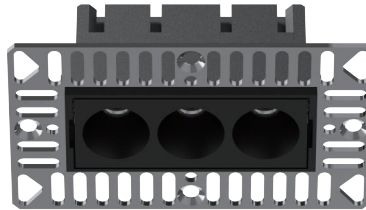

baffle



matt white painted



matt black painted

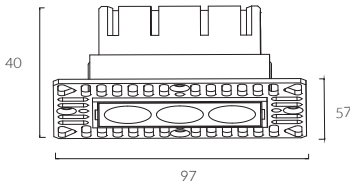

IP Rating:	IP20 and IP44 options
Optics:	14°/25°/35°
UGR:	< 10
CRI:	92Ra
Lifetime:	> 50,000 hrs (L70 B10)
CCT:	3000K/3500K/2700K-6000K
Typical Source Efficacy (lm/W):	113
Control:	On/off, Mains Dim, 0/1-10V, Dali, Zigbee, Casambi
Binning	2 Step MacAdams
Input:	AC220-240V 50/60Hz
Output:	DC 9V 500mA 8W DC 9V 700mA 8W
Ambient temp:	-20 °C to 45 °C
Class:	II
Material:	Fine aluminium 6063A

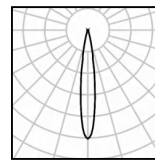

8W Ra92 3000K 14°

h(m)	E lx	D(m)
0.5	7614	0.14
1.0	1904	0.28
1.5	846	0.42
2.0	476	0.56
2.5	305	0.70
3.0	212	0.84

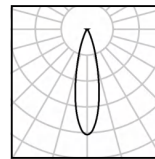

8W Ra92 3000K 25°

h(m)	E lx	D(m)
0.5	2824	0.25
1.0	706	0.50
1.5	314	0.75
2.0	176	1.00
2.5	113	1.26
3.0	78	1.51

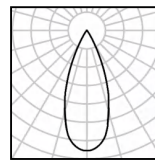

8W Ra92 3000K 35°

h(m)	E lx	D(m)
0.5	2277	0.31
1.0	569	0.62
1.5	253	0.92
2.0	142	1.23
2.5	91	1.54
3.0	63	1.85



DuraGreen project:
Guangzhou Private Club

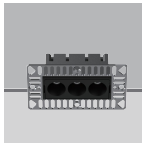

W system	lm system	optics	code
6W	305	14°	ETL0306W-30N14-B
6W	296	25°	ETL0306W-30N25-B
6W	375	35°	ETL0306W-30N35-B

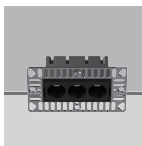

W system	lm system	optics	code
8W	377	14°	ETL0308W-30N14-B
8W	372	25°	ETL0308W-30N25-B
8W	491	35°	ETL0308W-30N35-B



130X25 Recessed 6 Spots Fixed Line



view on website



cutout:130X25mm



Fixed Optic

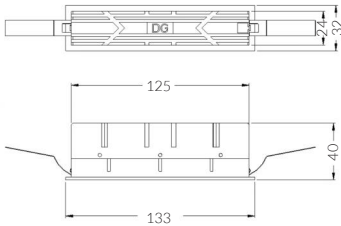

bezel | baffle



matt white painted



matt black painted

IP Rating:	IP20 and IP44 options
Optics:	14°/25°/35°
UGR:	< 10
CRI:	92Ra
Lifetime:	>50,000 hrs (L70 B10)
CCT:	3000K/3500K/2700K-6000K
Typical Source	
Efficacy (lm/W):	113
Control:	On/off, Mains Dim, 0/1-10V, Dali, Zigbee, Casambi
Binning	2 Step MacAdams
Input:	AC220-240V 50/60Hz
Output:	DC 18V 400mA 8W DC 18V 500mA 10W DC 18V 600mA 12W
Ambient temp:	-20 °C to 45 °C
Class:	II
Ceiling Thickness:	5mm-28mm
Material:	Fine aluminium 6063A

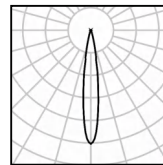

12W Ra92 3000K 14°

h(m)	E(lx)	D(m)
0.5	15873	0.13
1.0	3968	0.26
1.5	1764	0.39
2.0	992	0.52
2.5	635	0.65
3.0	441	0.78

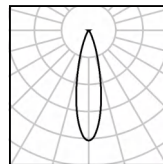

12W Ra92 3000K 25°

h(m)	E(lx)	D(m)
0.5	5481	0.23
1.0	1370	0.45
1.5	609	0.68
2.0	343	0.91
2.5	219	1.14
3.0	152	1.36

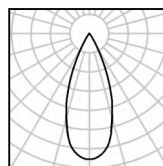

12W Ra92 3000K 35°

h(m)	E(lx)	D(m)
0.5	4125	0.34
1.0	1031	0.68
1.5	458	1.02
2.0	258	1.35
2.5	165	1.69
3.0	115	2.03

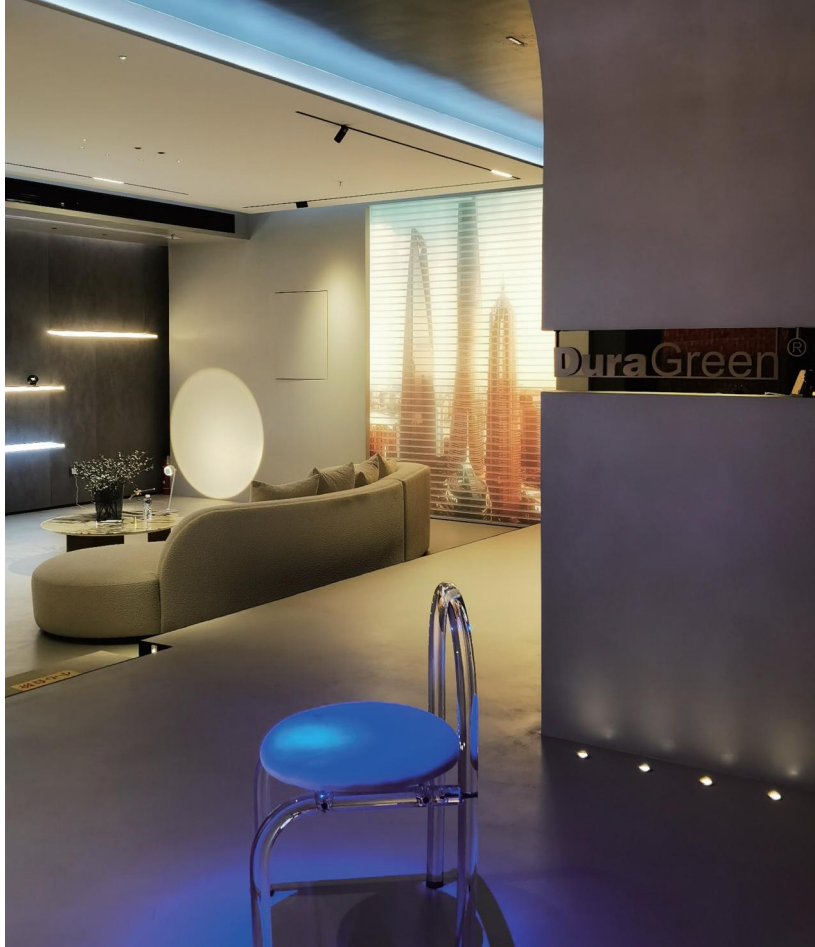

DuraGreen project:
DuraGreen Showroom

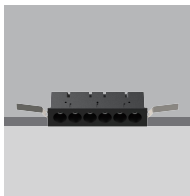

W system	lm system	optics	code
8W	553	14°	EFL0608W-30N14-B
8W	563	25°	EFL0608W-30N25-B
8W	605	35°	EFL0608W-30N35-B

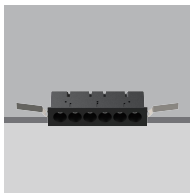

W system	lm system	optics	code
10W	648	14°	EFL0610W-30N14-B
10W	615	25°	EFL0610W-30N25-B
10W	660	35°	EFL0610W-30N35-B

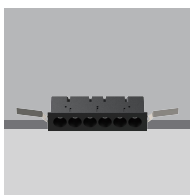

W system	lm system	optics	code
12W	772	14°	EFL0612W-30N14-B
12W	680	25°	EFL0612W-30N25-B
12W	790	35°	EFL0612W-30N35-B

134X32 Recessed 6 Spots Trimless Line



view on website



cutout:134X32mm



Fixed Optic

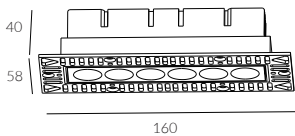
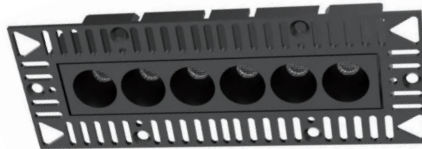

bezel | baffle

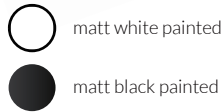

IP Rating:	IP20 and IP44 options
Optics:	14°/25°/35°
UGR:	< 10
CRI:	92Ra
Lifetime:	>50,000 hrs (L70 B10)
CCT:	3000K/3500K/2700K-6000K
Typical Source Efficacy (lm/W):	113
Control:	On/off, Mains Dim, 0/1-10V, Dali, Zigbee, Casambi
Binning	2 Step MacAdams
Input:	AC220-240V 50/60Hz
Output:	DC 18V 400mA 8W DC 18V 500mA 10W DC 18V 600mA 12W
Ambient temp:	-20 °C to 45 °C
Class:	II
Ceiling Thickness:	5mm-28mm
Material:	Fine aluminium 6063A

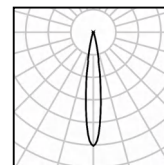

12W Ra92 3000K 14°

h(m)	E(lx)	D(m)
0.5	15873	0.13
1.0	3968	0.26
1.5	1764	0.39
2.0	992	0.52
2.5	635	0.65
3.0	441	0.78

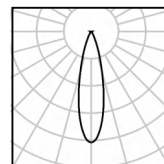

12W Ra92 3000K 25°

h(m)	E(lx)	D(m)
0.5	5481	0.23
1.0	1370	0.45
1.5	609	0.68
2.0	343	0.91
2.5	219	1.14
3.0	152	1.36

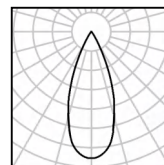

12W Ra92 3000K 35°

h(m)	E(lx)	D(m)
0.5	4125	0.34
1.0	1031	0.68
1.5	458	1.02
2.0	258	1.35
2.5	165	1.69
3.0	115	2.03



DuraGreen project:
HUAWEI Smart Home



W system	lm system	optics	code
8W	553	14°	ETL0608W-30N14-B
8W	563	25°	ETL0608W-30N25-B
8W	605	35°	ETL0608W-30N35-B

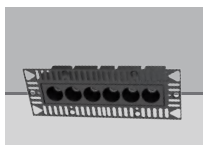

W system	lm system	optics	code
10W	648	14°	ETL0610W-30N14-B
10W	615	25°	ETL0610W-30N25-B
10W	660	35°	ETL0610W-30N35-B

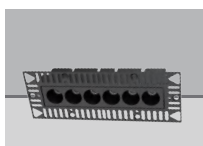

W system	lm system	optics	code
12W	772	14°	ETL0612W-30N14-B
12W	680	25°	ETL0612W-30N25-B
12W	790	35°	ETL0612W-30N35-B

EVOLINE



reddot winner 2023
lighting design



194X25 Recessed 9 Spots Fixed Line



view on website



cutout:194X25mm



Fixed Optic



bezel | baffle



matt white painted



matt black painted

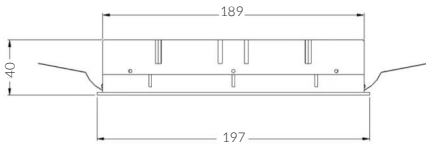

IP Rating:	IP20 and IP44 options
Optics:	14°/25°/35°
UGR:	<10
CRI:	92Ra
Lifetime:	>50,000 hrs (L70 B10)
CCT:	3000K/3500K/2700K-6000K
Typical Source Efficacy (lm/W):	113
Control:	On/off, Mains Dim, 0/1-10V, Dali, Zigbee, Casambi
Binning	2 Step MacAdams
Input:	AC 220-240V 50/60Hz
Output:	DC 27V 500mA 15W DC 27V 700mA 20W
Ambient temp:	-20 °C to 45 °C
Class:	II
Ceiling Thickness:	5mm-28mm
Material:	Fine aluminium 6063A

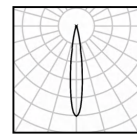

20W Ra92 3000K 14°

h(m)	E(lx)	D(m)
1.5	3287	0.46
2.0	1849	0.61
4.0	462	1.25
4.5	365	1.40
6.0	205	1.87

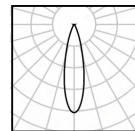

20W Ra92 3000K 25°

h(m)	E(lx)	D(m)
1.5	1661	0.63
2.0	935	0.84
4.0	234	1.69
4.5	185	1.90
6.0	104	2.53

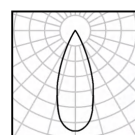

20W Ra92 3000K 35°

h(m)	E(lx)	D(m)
1.5	1045	0.93
2.0	588	1.24
4.0	147	2.47
4.5	116	2.78
6.0	65	3.70

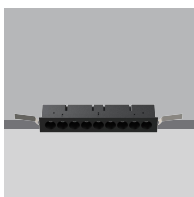

W system	lm system	optics	code
15W	1032	14°	EFL0915W-30N14-B
15W	956	25°	EFL0915W-30N25-B
15W	937	35°	EFL0915W-30N35-B

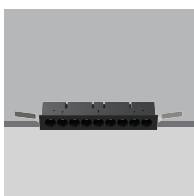

W system	lm system	optics	code
20W	1439	14°	EFL0920W-30N14-B
20W	1264	25°	EFL0920W-30N25-B
20W	1263	35°	EFL0920W-30N35-B

EVOLINE

68X66 Recessed Square



view on website



cutout: 68X66



Fixed Optic

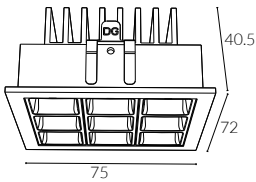

Bezel

-  matt white painted
-  matt black painted

- IP Rating:** IP20 and IP44 options
- Optics:** 50°
- UGR:** <17
- CRI:** 92Ra
- Lifetime:** >50,000 hrs (L70 B10)
- CCT:** 3000K/3500K
- Typical Source Efficacy (lm/W):** 113
- Control:** On/off, Mains Dim, 0/1-10V, Dali, Zigbee, Casambi
- Binning:** 2 Step MacAdams
- Input:** AC220-240V 50/60Hz
- Output:** DC 27V 300mA 8W
- Ambient temp:** -20 °C to 45 °C
- Class:** II
- Ceiling Thickness:** 5mm-28mm
- Material:** Fine aluminium 6063A

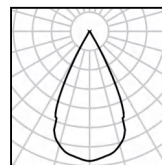

8W Ra92 3000K 50°

h(m)	E(lx)	D(m)
0.5	907	0.48
1.0	227	0.96
1.5	101	1.44
2.0	57	1.93
2.5	36	2.41
3.0	25	2.89

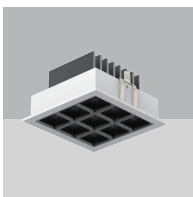
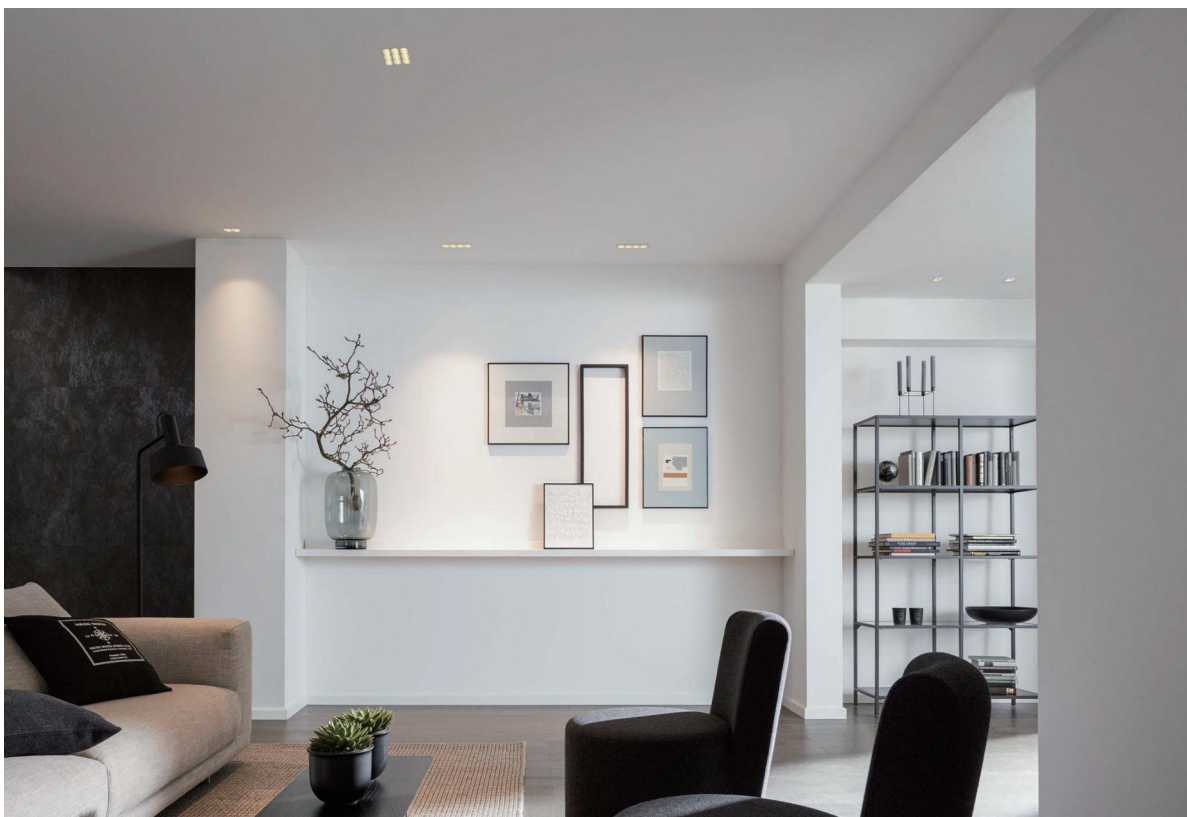

W system	lm system	optics	code
8W	458	50°	EFQ0908W-30N50-W

ACME



Black Nickel



Solid Brass



Antique Bronze



Black Painted 9005



White Painted 9016



Brushed Grey



Polished Chrome

Our light fixtures are made of the highest quality metal materials, like pure aluminium and solid brass. Our process is precise and sustainable to achieve circular products that last longer and look stylish.

The ACME light engines come in three distinct shapes: straight baffle for maximum brightness, curve baffle for a softer light effect, and semi-recessed baffle for added ceiling decoration. They are available in five different sizes with both trimmed and trimless bezels (cutouts of 50mm, 57mm, 68mm, and 78mm) and offered in seven standard finishes including white 9016, black 9005, polished chrome, black nickel, antique bronze, and solid brass.



ACME STRAIGHT



ACME CURVE



ACME SEMI

We transform premium materials into fine luxury goods that elevate any space.



Light engine



Installation frame trimless



Installation frame trim

Circular economy principles are intricately woven into every stage of our design and manufacturing process, making ACME downlights a shining example of sustainability. These fixtures are fully modular, allowing for easy repair, reuse, and end-of-life reintroduction into standard stock.

Safety wire



Accessories

Spread



Double Asymmetric



Honeycomb



Red filter



Blue filter



Amber filter





36mm

One frame, endless possibilities



Downlight
Trim



Spotlight
Trimless



Downlight
Trimless



Spotlight
Trimless



Zoomable
Trimless

Zoomable Pendant
Trimless



50mm

One frame, endless possibilities



Straight
Trim



Semi
Trim



SPY
Trim



Straight
Trimless



Semi
Trimless



SPY
Trimless



Curve
Trim



Pinhole
Trim



Microwave Motion Sensor
+ Light Sensor DALI/CASAMBI/ZIGBEE



Curve
Trimless



Pinhole
Trimless



PIR Motion Sensor
+ Light Sensor DALI/CASAMBI/ZIGBEE



Pendant
Trimless



One frame, endless possibilities



Straight
Trim



Semi
Trim



Straight
Trimless



Semi
Trimless



Curve
Trim



SPY
Trim



Pendant
Trimless



Pendant
Trimless



Curve
Trimless



SPY
Trimless





68mm

One frame, endless possibilities



Straight Trim



Curve Trim



SPY Trim



Pendant Trimless



Pendant Trimless



Straight Trimless



Curve Trimless



SPY Trimless



Pendant Trimless

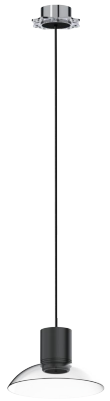

Pendant Trimless



Straight Shallow



Semi Trim



Wallwash Trim



Pendant Trimless



Straight Shallow Trimless



Semi Trimless



Wallwash Trimless



Pendant Trimless



78mm

One frame, endless possibilities



Straight Trim



Semi Trim



SPY Trim



Straight Trimless



Semi Trimless



SPY Trimless



Straight Fixed Trim



Curve Trim



SPY Short Snoot Trimless



Straight Fixed Trimless



Curve Trimless



SPY Long Snoot Trimless

ACME STRAIGHT

Φ36 Engine Fixed Round Downlight



view on website



cutout: 36mm



Fixed Optic

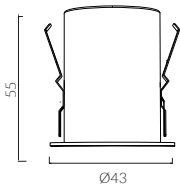

bezel | baffle



Black Painted
9005



White Painted
9016

IP Rating:	IP20
Optics:	24°
UGR:	<10
CRI:	92Ra
Lifetime:	>50,000 hrs (L70 B10)
CCT:	3000K/3500K
Typical Source	
Efficacy (lm/W):	103
Control:	On/off, Mains Dim, 0/1-10V, Dali, Zigbee, Casambi
Binning	2 Step MacAdams
Input:	AC220-240V 50/60Hz
Output:	DC 12V 300mA 5W
Ambient temp:	-20 °C to 45 °C
Class:	II
Ceiling Thickness:	5mm-28mm
Material:	Fine aluminium 6063A

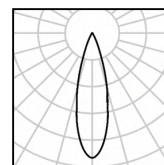

5W Ra92 3000K 24°

h(m)	E(lx)	D(m)
0.5	1582	0.19
1.0	396	0.38
1.5	176	0.57
2.0	99	0.76
2.5	63	0.95
3.0	44	1.14



DuraGreen project:
KY Office



W system	lm system	optics	code
5W	127	24°	MFL3605W-30N24-W

ACME STRAIGHT

Φ36 Engine

Trimless Fixed Round Downlight



view on website



cutout:36mm



Fixed Optic

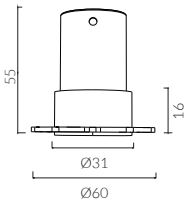

baffle



- IP Rating:** IP20
- Optics:** 24°
- UGR:** <10
- CRI:** 92Ra
- Lifetime:** >50,000 hrs (L70 B10)
- CCT:** 3000K/3500K
- Typical Source**
- Efficacy (lm/W):** 103
- Control:** On/off, Mains Dim, 0/1-10V, Dali, Zigbee, Casambi
- Binning** 2 Step MacAdams
- Input:** AC220-240V 50/60Hz
- Output:** DC 12V 300mA 5W
- Ambient temp:** -20 C to 45 C
- Class:** II
- Material:** Fine aluminium 6063A

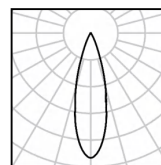

5W Ra92 3000K 24°

h(m)	E(lx)	D(m)
0.5	1582	0.19
1.0	396	0.38
1.5	176	0.57
2.0	99	0.76
2.5	63	0.95
3.0	44	1.14



W system	lm system	optics	code
5W	127	24°	MFL3605W-TL-30N24-W

ACME STRAIGHT

Φ50 Engine Adjustable Round Downlight



view on website



cutout:50mm



Adjustable Optic

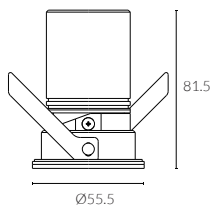

bezel | baffle



Black Painted
9005



White Painted
9016

IP Rating:	IP20 and IP44 options
Optics:	15°/24°/36°
UGR:	< 10
CRI:	98Ra
Lifetime:	>50,000 hrs (L70 B10)
CCT:	2700K/3000K/3500K/4000K/5000K/ 2000K-3000K/1800K-4000K/2700K-6000K

Typical Source Efficacy (lm/W):	110
Control:	On/off, Mains Dim, 0/1-10V, Dali, Zigbee, Casambi
Binning	2 Step MacAdams
Input:	AC220-240V 50/60Hz
Output:	DC 36V 100mA 4W DC 36V 150mA 6W DC 36V 200mA 8W

Ambient temp:	-20 °C to 45 °C
Class:	II
Optional accessories:	Honeycomb louvre, Solite Lense, Spread Lense, Colour Filter

Ceiling Thickness:	9mm-28mm
Material:	Fine aluminium 6063A
Fire resistance test:	60 minutes

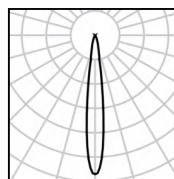

8W Ra98 3000K 15°

h(m)	E(lx)	D(m)
0.5	7204	0.11
1.0	1801	0.22
1.5	800	0.33
2.0	450	0.43
2.5	288	0.54
3.0	200	0.65

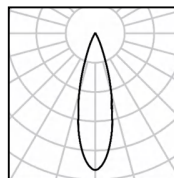

8W Ra98 3000K 24°

h(m)	E(lx)	D(m)
0.5	2613	0.25
1.0	653	0.49
1.5	290	0.74
2.0	163	0.99
2.5	105	1.24
3.0	73	1.48

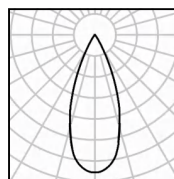

8W Ra98 3000K 36°

h(m)	E(lx)	D(m)
0.5	2005	0.34
1.0	501	0.68
1.5	223	1.03
2.0	125	1.37
2.5	80	1.71
3.0	56	2.05



DuraGreen project:
Luxury Home Guangzhou



W System	Lm System	Optics	Code
4W	182	15°	AFL5004W-30N15-B
4W	205	24°	AFL5004W-30N24-B
4W	247	36°	AFL5004W-30N36-B



W System	Lm System	Optics	Code
6W	267	15°	AFL5006W-30N15-B
6W	306	24°	AFL5006W-30N24-B
6W	368	36°	AFL5006W-30N36-B



W System	Lm System	Optics	Code
8W	336	15°	AFL5008W-30N15-B
8W	381	24°	AFL5008W-30N24-B
8W	453	36°	AFL5008W-30N36-B

ACME STRAIGHT

Φ50 Engine

Trimless Adjustable Round Downlight



view on website



cutout:50mm



Adjustable Optic



baffle



Black Painted
9005



White Painted
9016

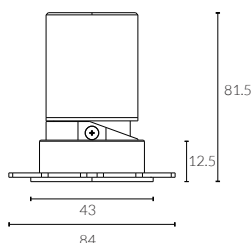

IP Rating:	IP20 and IP44 options
Optics:	15°/24°/36°
UGR:	< 10
CRI:	98Ra
Lifetime:	>50,000 hrs (L70 B10)
CCT:	2700K/3000K/3500K/4000K/5000K/ 2000K-3000K/1800K-4000K/2700K-6000K

Typical Source Efficacy (lm/W):	110
Control:	On/off, Mains Dim, 0/1-10V, Dali, Zigbee, Casambi
Binning	2 Step MacAdams
Input:	AC220-240V 50/60Hz
Output:	DC 36V 100mA 4W DC 36V 150mA 6W DC 36V 200mA 8W

Ambient temp:	-20 °C to 45 °C
Class:	II
Optional accessories:	Honeycomb louvre, Solite Lense, Spread Lense, Colour Filter

Material:	Fine aluminium 6063A
Fire resistance test:	60 minutes

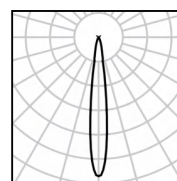

8W Ra98 3000K 15°

h(m)	E(lx)	D(m)
0.5	7204	0.11
1.0	1801	0.22
1.5	800	0.33
2.0	450	0.43
2.5	288	0.54
3.0	200	0.65

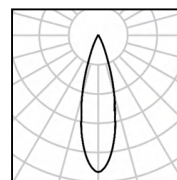

8W Ra98 3000K 24°

h(m)	E(lx)	D(m)
0.5	2613	0.25
1.0	653	0.49
1.5	290	0.74
2.0	163	0.99
2.5	105	1.24
3.0	73	1.48

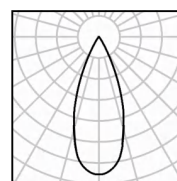

8W Ra98 3000K 36°

h(m)	E(lx)	D(m)
0.5	2005	0.34
1.0	501	0.68
1.5	223	1.03
2.0	125	1.37
2.5	80	1.71
3.0	56	2.05



W System	Lm System	Optics	Code
4W	182	15°	AFL5004W-TL-30N15
4W	205	24°	AFL5004W-TL-30N24
4W	247	36°	AFL5004W-TL-30N36



W System	Lm System	Optics	Code
6W	267	15°	AFL5006W-TL-30N15
6W	306	24°	AFL5006W-TL-30N24
6W	368	36°	AFL5006W-TL-30N36



W System	Lm System	Optics	Code
8W	336	15°	AFL5008W-TL-30N15
8W	381	24°	AFL5008W-TL-30N24
8W	453	36°	AFL5008W-TL-30N36

ACME PINHOLE

Φ50 Engine

Adjustable Round Downlight



view on website



cutout:50mm

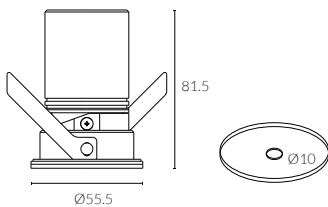

LIGHT SNIPER - PINHOLE

bezel | baffle



IP Rating:	IP20 and IP44 options
Optics:	28°/33°
UGR:	< 10
CRI:	98Ra
Lifetime:	> 50,000 hrs (L70 B10)
CCT:	2700K/3000K/3500K/4000K/5000K/ 2000K-3000K/1800K-4000K/2700K-6000K

Typical Source	
Efficacy (lm/W):	110
Control:	On/off, Mains Dim, 0/1-10V, Dali, Zigbee, Casambi
Binning	2 Step MacAdams
Input:	AC220-240V 50/60Hz
Output:	DC 36V 150mA 6W DC 36V 200mA 8W

Ambient temp: -20 °C to 45 °C

Class: II

Optional accessories: Honeycomb louvre, Solite Lense, Spread Lense, Colour Filter

Ceiling Thickness: 9mm-28mm

Material: Fine aluminium 6063A

Fire resistance test: 60 minutes

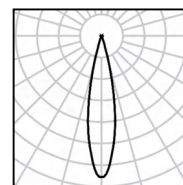

8W Ra98 3000K 28°

h(m)	E(lx)	D(m)
0.5	2921	0.25
1.0	730	0.50
1.5	325	0.75
2.0	183	1.00
2.5	117	1.25
3.0	81	1.50

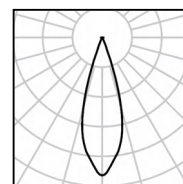

8W Ra98 3000K 33°

h(m)	E(lx)	D(m)
0.5	2392	0.29
1.0	598	0.58
1.5	266	0.88
2.0	149	1.17
2.5	96	1.46
3.0	66	1.75



DuraGreen project:
Rimadesio Showroom



W system	lm system	optics	code
6W	258	28°	AFL5006W-P-30N28-B
6W	295	33°	AFL5006W-P-30N33-B



W system	lm system	optics	code
8W	318	28°	AFL5008W-P-30N28-B
8W	356	33°	AFL5008W-P-30N33-B

ACME PINHOLE

Φ50 Engine

Trimless Adjustable Round Downlight



view on website



cutout:50mm



360°

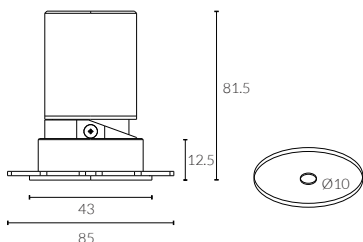

baffle



Black Painted
9005



White Painted
9016

LIGHT SNIPER -PINHOLE

IP Rating:	IP20 and IP44 options
Optics:	28°/33°
UGR:	< 10
CRI:	98Ra
Lifetime:	>50,000 hrs (L70 B10)
CCT:	2700K/3000K/3500K/4000K/5000K/ 2000K-3000K/1800K-4000K/2700K-6000K

Typical Source

Efficacy (lm/W):	110
Control:	On/off, Mains Dim, 0/1-10V, Dali, Zigbee, Casambi
Binning	2 Step MacAdams
Input:	AC220-240V 50/60Hz
Output:	DC 36V 150mA 6W DC 36V 200mA 8W

Ambient temp:	-20 °C to 45 °C
Class:	II
Material:	Fine aluminium 6063A
Fire resistance test:	60 minutes

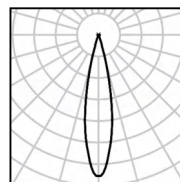

8W Ra98 3000K 28°

h(m)	E(lx)	D(m)
0.5	2921	0.25
1.0	730	0.50
1.5	325	0.75
2.0	183	1.00
2.5	117	1.25
3.0	81	1.50

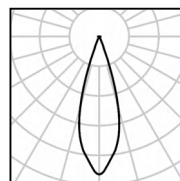

8W Ra98 3000K 33°

h(m)	E(lx)	D(m)
0.5	2392	0.29
1.0	598	0.58
1.5	266	0.88
2.0	149	1.17
2.5	96	1.46
3.0	66	1.75



W system	lm system	optics	code
6W	258	28°	AFL5006W-P-TL-30N28-B
6W	295	33°	AFL5006W-P-TL-30N33-B



W system	lm system	optics	code
8W	318	28°	AFL5008W-P-TL-30N28-B
8W	356	33°	AFL5008W-P-TL-30N33-B

ACME STRAIGHT

Φ57 Engine

Adjustable Round Downlight



view on website



cutout :57mm



Adjustable Optic



bezel | baffle



Black Painted
9005

White Painted
9016

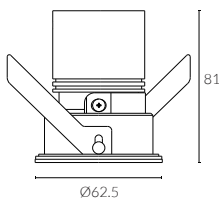

IP Rating:	IP20 and IP44 options
Optics:	15°/24°/36°
UGR:	<10
CRI:	98Ra
Lifetime:	>50,000 hrs (L70 B10)
CCT:	2700K/3000K/3500K/4000K/5000K/ 2000K-3000K/1800K-4000K/2700K-6000K

Typical Source Efficacy (lm/W):	110
Control:	On/off, Mains Dim, 0/1-10V, Dali, Zigbee, Casambi
Binning	2 Step MacAdams
Input:	AC220-240V 50/60Hz
Output:	DC 36V 150mA 6W DC 36V 200mA 8W DC 36V 250mA 10W

Ambient temp:	-20 °C to 45 °C
Class:	II
Optional accessories:	Honeycomb louvre, Solite Lense, Spread Lense, Colour Filter

Ceiling Thickness:	9mm-28mm
Material:	Fine aluminium 6063A
Fire resistance test:	60 minutes

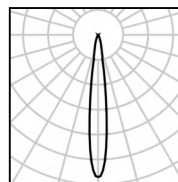

10W Ra98 3000K 15°

h(m)	E(lx)	D(m)
0.5	10728	0.15
1.0	2682	0.31
1.5	1192	0.46
2.0	671	0.61
2.5	429	0.77
3.0	298	0.92

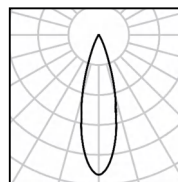

10W Ra98 3000K 24°

h(m)	E(lx)	D(m)
0.5	7580	0.21
1.0	1895	0.42
1.5	842	0.63
2.0	474	0.84
2.5	303	1.04
3.0	211	1.25

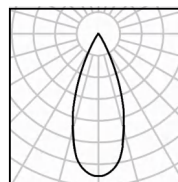

10W Ra98 3000K 36°

h(m)	E(lx)	D(m)
0.5	4206	0.28
1.0	1051	0.57
1.5	467	0.85
2.0	263	1.14
2.5	168	1.42
3.0	117	1.71

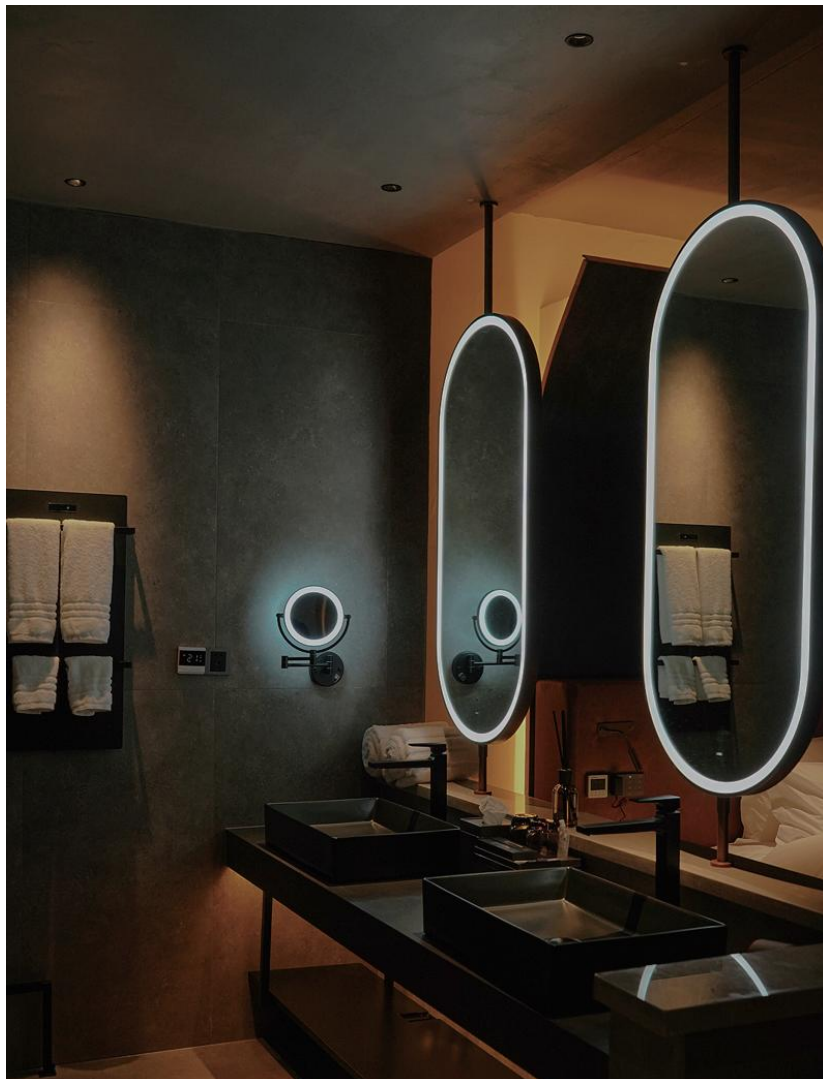

DuraGreen project:
Black Stone Hillside Hotel



W system	lm system	optics	code
6W	367	15°	AFL5706W-30N15-B
6W	349	24°	AFL5706W-30N24-B
6W	340	36°	AFL5706W-30N36-B



W system	lm system	optics	code
8W	419	15°	AFL5708W-30N15-B
8W	470	24°	AFL5708W-30N24-B
8W	456	36°	AFL5708W-30N36-B



W system	lm system	optics	code
10W	462	15°	AFL5710W-30N15-B
10W	628	24°	AFL5710W-30N24-B
10W	616	36°	AFL5710W-30N36-B

ACME STRAIGHT

Φ57 Engine

Trimless Adjustable Round Downlight



view on website



cutout:57mm



Adjustable Optic

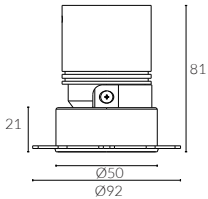

baffle



Black Painted
9005



White Painted
9016

view on website

IP Rating:	IP20 and IP44 options
Optics:	15°/24°/36°
UGR:	<10
CRI:	98Ra
Lifetime:	>50,000 hrs (L70 B10)
CCT:	2700K/3000K/3500K/4000K/5000K/ 2000K-3000K/1800K-4000K/2700K-6000K

Typical Source	
Efficacy (lm/W):	110
Control:	On/off, Mains Dim, 0/1-10V, Dali, Zigbee, Casambi
Binning	2 Step MacAdams
Input:	AC220-240V 50/60Hz
Output:	DC 36V 150mA 6W DC 36V 200mA 8W DC 36V 250mA 10W

Ambient temp:	-20 °C to 45 °C
Class:	II
Optional accessories:	Honeycomb louvre, Solite Lense, Spread Lense, Colour Filter
Material:	Fine aluminium 6063A
Fire resistance test:	60 minutes

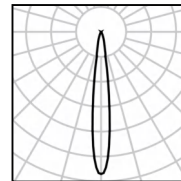

10W Ra98 3000K 15°

h(m)	E(lx)	D(m)
0.5	10728	0.15
1.0	2682	0.31
1.5	1192	0.46
2.0	671	0.61
2.5	429	0.77
3.0	298	0.92

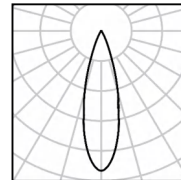

10W Ra98 3000K 24°

h(m)	E(lx)	D(m)
0.5	7580	0.21
1.0	1895	0.42
1.5	842	0.63
2.0	474	0.84
2.5	303	1.04
3.0	211	1.25

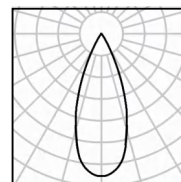

10W Ra98 3000K 36°

h(m)	E(lx)	D(m)
0.5	4206	0.28
1.0	1051	0.57
1.5	467	0.85
2.0	263	1.14
2.5	168	1.42
3.0	117	1.71



W system	lm system	optics	code
6W	367	15°	AFL5706W-TL-30N15-B
6W	349	24°	AFL5706W-TL-30N24-B
6W	340	36°	AFL5706W-TL-30N36-B



W system	lm system	optics	code
8W	419	15°	AFL5708W-TL-30N15-B
8W	470	24°	AFL5708W-TL-30N24-B
8W	456	36°	AFL5708W-TL-30N36-B



W system	lm system	optics	code
10W	462	15°	AFL5710W-TL-30N15-B
10W	628	24°	AFL5710W-TL-30N24-B
10W	616	36°	AFL5710W-TL-30N36-B

ACME STRAIGHT

Φ68 Engine Adjustable Round Downlight



view on website



cutout :68mm



Adjustable Optic



bezel | baffle

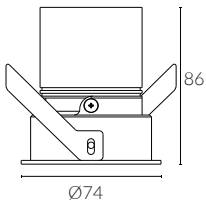

IP Rating:	IP20 and IP44 options
Optics:	15°/24°/36°/50°
UGR:	< 10
CRI:	98Ra
Lifetime:	>50,000 hrs (L70 B10)
CCT:	2700K/3000K/3500K/4000K/5000K/ 2000K-3000K/1800K-4000K/2700K-6000K

Typical Source Efficacy (lm/W):	110
Control:	On/off, Mains Dim, 0/1-10V, Dali, Zigbee, Casambi
Binning:	2 Step MacAdams
Input:	AC220-240V 50/60Hz
Output:	DC 36V 200mA 8W DC 36V 250mA 10W DC 36V 300mA 12W

Ambient temp:	-20 °C to 45 °C
Class:	II
Optional accessories:	Honeycomb louvre, Solite Lense, Spread Lense, Colour Filter

Ceiling Thickness:	9mm-28mm
Material:	Fine aluminium 6063A
Fire resistance test:	60 minutes

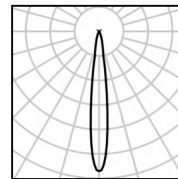

12W Ra98 3000K 15°

h(m)	E(lx)	D(m)
0.5	10897	0.17
1.0	2724	0.33
1.5	1211	0.50
2.0	681	0.66
2.5	436	0.83
3.0	303	0.99

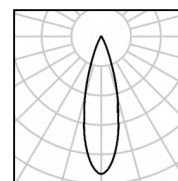

12W Ra98 3000K 24°

h(m)	E(lx)	D(m)
0.5	8621	0.20
1.0	2155	0.41
1.5	958	0.61
2.0	539	0.81
2.5	345	1.02
3.0	239	1.22

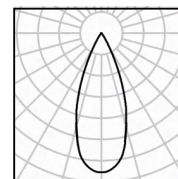

12W Ra98 3000K 36°

h(m)	E(lx)	D(m)
0.5	4792	0.28
1.0	1198	0.55
1.5	532	0.83
2.0	300	1.10
2.5	192	1.38
3.0	133	1.65

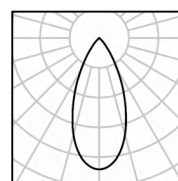

12W Ra98 3000K 50°

h(m)	E(lx)	D(m)
0.5	1608	0.47
1.0	402	0.93
1.5	179	1.40
2.0	100	1.87
2.5	64	2.33
3.0	45	2.80



DuraGreen project:
Luxury Apartment



W system	lm system	optics	code
8W	487	15°	AFL6808W-30N15-B
8W	503	24°	AFL6808W-30N24-B
8W	492	36°	AFL6808W-30N36-B
8W	427	50°	AFL6808W-30N50-B



W system	lm system	optics	code
10W	553	15°	AFL6810W-30N15-B
10W	575	24°	AFL6810W-30N24-B
10W	565	36°	AFL6810W-30N36-B
10W	485	50°	AFL6810W-30N50-B



W system	lm system	optics	code
12W	717	15°	AFL6812W-30N15-B
12W	760	24°	AFL6812W-30N24-B
12W	750	36°	AFL6812W-30N36-B
12W	640	50°	AFL6812W-30N50-B

ACME STRAIGHT

Φ68 Engine Trimless Adjustable Round Downlight



view on website



cutout :68mm



Adjustable Optic



baffle

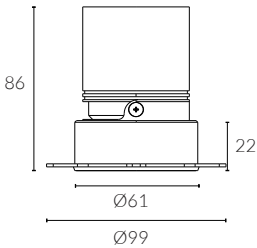

- IP Rating:** IP20 and IP44 options
- Optics:** 15°/24°/36°/50°
- UGR:** < 10
- CRI:** 98Ra
- Lifetime:** > 50,000 hrs (L70 B10)
- CCT:** 2700K/3000K/3500K/4000K/5000K/
2000K-3000K/1800K-4000K/2700K-6000K

- Typical Source Efficacy (lm/W):** 110
- Control:** On/off, Mains Dim, 0/1-10V, Dali, Zigbee, Casambi
- Binning:** 2 Step MacAdams
- Input:** AC220-240V 50/60Hz
- Output:** DC 36V 200mA 8W
DC 36V 250mA 10W
DC 36V 300mA 12W

- Ambient temp:** -20 °C to 45 °C
- Class:** II
- Optional accessories:** Honeycomb louvre, Solite Lense, Spread Lense, Colour Filter
- Material:** Fine aluminium 6063A
- Fire resistance test:** 60 minutes

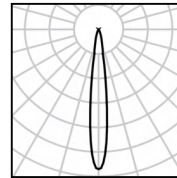

12W Ra98 3000K 15°

h(m)	E(lx)	D(m)
0.5	10897	0.17
1.0	2724	0.33
1.5	1211	0.50
2.0	681	0.66
2.5	436	0.83
3.0	303	0.99

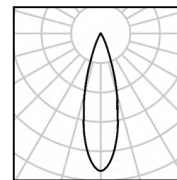

12W Ra98 3000K 24°

h(m)	E(lx)	D(m)
0.5	8621	0.20
1.0	2155	0.41
1.5	958	0.61
2.0	539	0.81
2.5	345	1.02
3.0	239	1.22

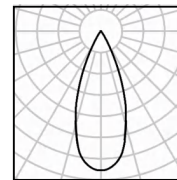

12W Ra98 3000K 36°

h(m)	E(lx)	D(m)
0.5	4792	0.28
1.0	1198	0.55
1.5	532	0.83
2.0	300	1.10
2.5	192	1.38
3.0	133	1.65

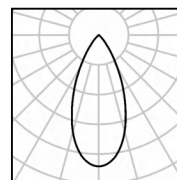

12W Ra98 3000K 50°

h(m)	E(lx)	D(m)
0.5	1608	0.47
1.0	402	0.93
1.5	179	1.40
2.0	100	1.87
2.5	64	2.33
3.0	45	2.80

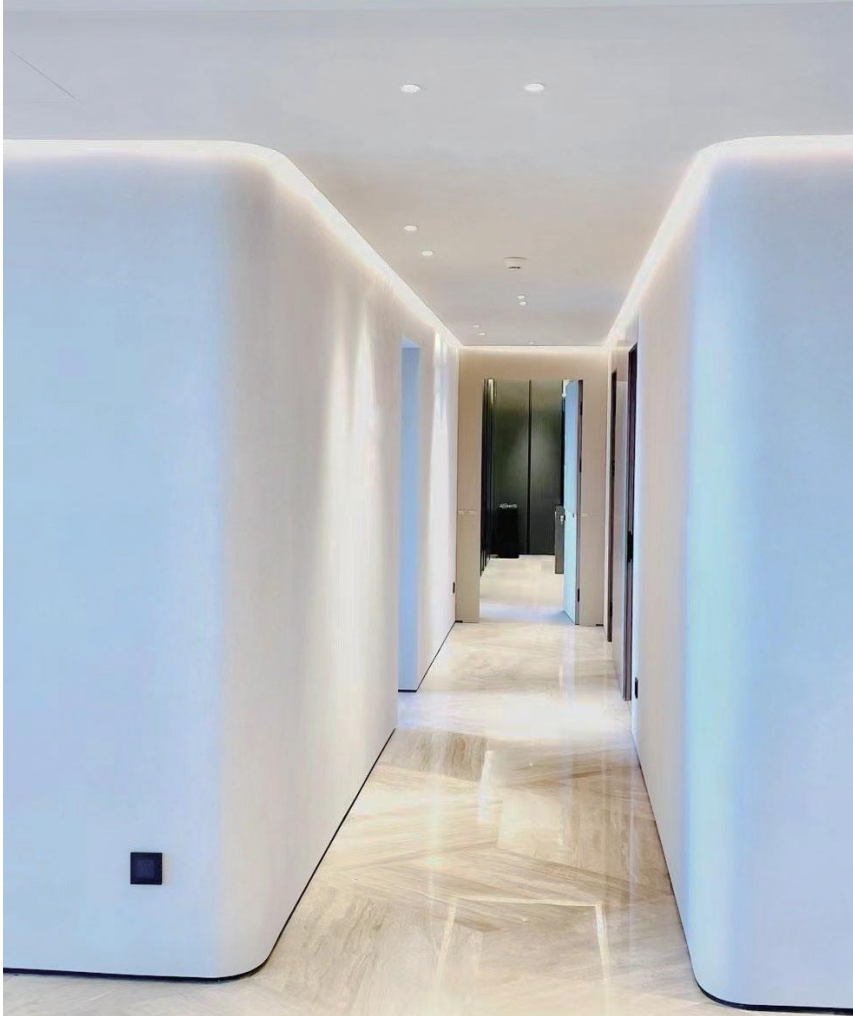

DuraGreen project:
Tomson Riverside Residential



W system	lm system	optics	code
8W	487	15°	AFL6808W-TL-30N15
8W	503	24°	AFL6808W-TL-30N24
8W	492	36°	AFL6808W-TL-30N36
8W	427	50°	AFL6808W-TL-30N50



W system	lm system	optics	code
10W	553	15°	AFL6810W-TL-30N15
10W	575	24°	AFL6810W-TL-30N24
10W	565	36°	AFL6810W-TL-30N36
10W	485	50°	AFL6810W-TL-30N50



W system	lm system	optics	code
12W	717	15°	AFL6812W-TL-30N15
12W	760	24°	AFL6812W-TL-30N24
12W	750	36°	AFL6812W-TL-30N36
12W	640	50°	AFL6812W-TL-30N50

ACME STRAIGHT SHALLOW



Φ68 Engine Fixed Round Downlight



view on website

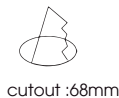

bezel | baffle

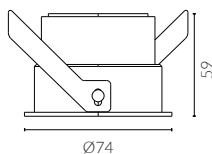

- IP Rating:** IP20 and IP44 options
- Optics:** 15°/24°/36°/50°
- UGR:** < 10
- CRI:** 98Ra
- Lifetime:** >50,000 hrs (L70 B10)
- CCT:** 2700K/3000K/3500K/4000K/5000K/
2000K-3000K/1800K-4000K/2700K-6000K

- Typical Source Efficacy (lm/W):** 110
- Control:** On/off, Mains Dim, 0/1-10V, Dali, Zigbee, Casambi
- Binning:** 2 Step MacAdams
- Input:** AC220-240V 50/60Hz
- Output:** DC 36V 200mA 8W
DC 36V 250mA 10W
- Ambient temp:** -20 °C to 45 °C
- Class:** II

Optional accessories: Honeycomb louvre, Solite Lense, Spread Lense, Colour Filter

- Ceiling Thickness:** 9mm-28mm
- Material:** Fine aluminium 6063A
- Fire resistance test:** 60 minutes

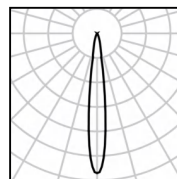

10W Ra98 3000K 15°

h(m)	E(lx)	D(m)
0.5	11475	0.15
1.0	2869	0.30
1.5	1275	0.45
2.0	717	0.60
2.5	459	0.76
3.0	319	0.91

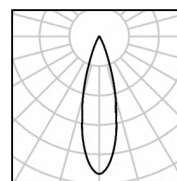

10W Ra98 3000K 24°

h(m)	E(lx)	D(m)
0.5	6198	0.22
1.0	1550	0.44
1.5	689	0.67
2.0	387	0.89
2.5	248	1.11
3.0	172	1.33

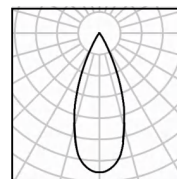

10W Ra98 3000K 36°

h(m)	E(lx)	D(m)
0.5	3390	0.31
1.0	847	0.62
1.5	377	0.92
2.0	212	1.23
2.5	136	1.54
3.0	94	1.85

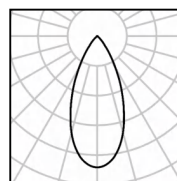

10W Ra98 3000K 50°

h(m)	E(lx)	D(m)
0.5	1133	0.49
1.0	283	0.98
1.5	126	1.47
2.0	71	1.96
2.5	45	2.45
3.0	31	2.94



DuraGreen project:
Mandarin Oriental, HK



W system	lm system	optics	code
8W	487	15°	AFL6808W/S-30N15-B
8W	503	24°	AFL6808W/S-30N24-B
8W	492	36°	AFL6808W/S-30N36-B
8W	427	50°	AFL6808W/S-30N50-B



W system	lm system	optics	code
10W	553	15°	AFL6810W/S-30N15-B
10W	575	24°	AFL6810W/S-30N24-B
10W	565	36°	AFL6810W/S-30N36-B
10W	485	50°	AFL6810W/S-30N50-B

ACME STRAIGHT SHALLOW



Φ68 Engine Trimless Fixed Round Downlight



view on website



cutout :68mm



Fixed Optic



baffle

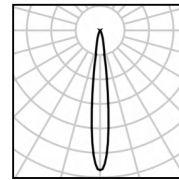
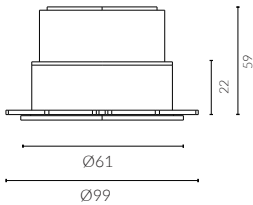

h(m)	E(lx)	D(m)
0.5	11475	0.15
1.0	2869	0.30
1.5	1275	0.45
2.0	717	0.60
2.5	459	0.76
3.0	319	0.91

10W Ra98 3000K 15°

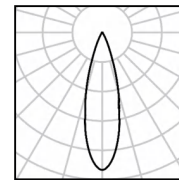

h(m)	E(lx)	D(m)
0.5	6198	0.22
1.0	1550	0.44
1.5	689	0.67
2.0	387	0.89
2.5	248	1.11
3.0	172	1.33

10W Ra98 3000K 24°

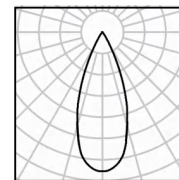

h(m)	E(lx)	D(m)
0.5	3390	0.31
1.0	847	0.62
1.5	377	0.92
2.0	212	1.23
2.5	136	1.54
3.0	94	1.85

10W Ra98 3000K 36°

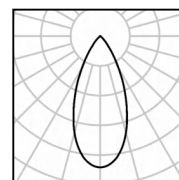

h(m)	E(lx)	D(m)
0.5	1133	0.49
1.0	283	0.98
1.5	126	1.47
2.0	71	1.96
2.5	45	2.45
3.0	31	2.94

10W Ra98 3000K 50°

- IP Rating:** IP20 and IP44 options
- Optics:** 15°/24°/36°/50°
- UGR:** <10
- CRI:** 98Ra
- Lifetime:** >50,000 hrs (L70 B10)
- CCT:** 2700K/3000K/3500K/4000K/5000K/
2000K-3000K/1800K-4000K/2700K-6000K

- Typical Source Efficacy (lm/W):** 110
- Control:** On/off, Mains Dim, 0/1-10V, Dali, Zigbee, Casambi
- Binning:** 2 Step MacAdams
- Input:** AC220-240V 50/60Hz
- Output:** DC 36V 200mA 8W
DC 36V 250mA 10W

- Ambient temp:** -20 °C to 45 °C
- Class:** II

- Optional accessories:** Honeycomb louvre, Solite Lense, Spread Lense, Colour Filter

- Material:** Fine aluminium 6063A

- Fire resistance test:** 60 minutes



DuraGreen project:
Curio Hotel by Hilton, Hanoi



W system	lm system	optics	code
8W	487	15°	AFL6808W/S-TL-30N15
8W	503	24°	AFL6808W/S-TL-30N24
8W	492	36°	AFL6808W/S-TL-30N36
8W	427	50°	AFL6808W/S-TL-30N50



W system	lm system	optics	code
10W	553	15°	AFL6810W/S-TL-30N15
10W	575	24°	AFL6810W/S-TL-30N24
10W	565	36°	AFL6810W/S-TL-30N36
10W	485	50°	AFL6810W/S-TL-30N50

ACME STRAIGHT

Φ78 Engine Adjustable Round Downlight



view on website



cutout: 78mm



Adjustable Optic



bezel | baffle

Black Painted
9005

White Painted
9016

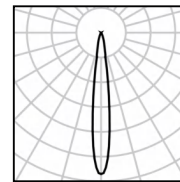
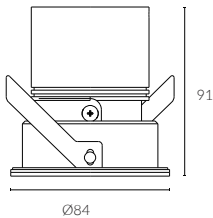

12W Ra98 3000K 15°

h(m)	E(lx)	D(m)
0.5	18360	0.13
1.0	4590	0.26
1.5	2040	0.39
2.0	1148	0.52
2.5	734	0.65
3.0	510	0.78

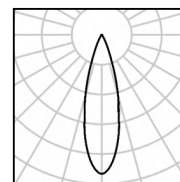

12W Ra98 3000K 24°

h(m)	E(lx)	D(m)
0.5	6420	0.22
1.0	1605	0.44
1.5	713	0.65
2.0	401	0.87
2.5	257	1.09
3.0	178	1.31

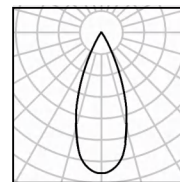

12W Ra98 3000K 36°

h(m)	E(lx)	D(m)
0.5	2791	0.31
1.0	698	0.62
1.5	310	0.93
2.0	174	1.25
2.5	112	1.56
3.0	78	1.87

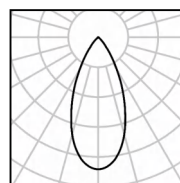

12W Ra98 3000K 50°

h(m)	E(lx)	D(m)
0.5	1324	0.52
1.0	331	1.03
1.5	147	1.55
2.0	83	2.06
2.5	53	2.58
3.0	37	3.10

IP Rating:	IP20 and IP44 options
Optics:	15°/24°/36°/50°
UGR:	< 10
CRI:	98Ra
Lifetime:	>50,000 hrs (L70 B10)
CCT:	2700K/3000K/3500K/4000K/5000K/ 2000K-3000K/1800K-4000K/2700K-6000K

Typical Source Efficacy (lm/W):	110
Control:	On/off, Mains Dim, 0/1-10V, Dali, Zigbee, Casambi
Binning:	2 Step MacAdams
Input:	AC220-240V 50/60Hz
Output:	DC 36V 200mA 8W DC 36V 250mA 10W DC 36V 300mA 12W

Ambient temp:	-20 °C to 45 °C
Class:	II
Optional accessories:	Honeycomb louvre, Solite Lense, Spread Lense, Colour Filter

Ceiling Thickness:	9mm-28mm
Material:	Fine aluminium 6063A
Fire resistance test:	60 minutes



DuraGreen project:
Luxury Apartment



W system	lm system	optics	code
8W	450	15°	AFL7808W-30N15-B
8W	442	24°	AFL7808W-30N24-B
8W	397	36°	AFL7808W-30N36-B
8W	327	50°	AFL7808W-30N50-B



W system	lm system	optics	code
10W	580	15°	AFL7810W-30N15-B
10W	563	24°	AFL7810W-30N24-B
10W	519	36°	AFL7810W-30N36-B
10W	500	50°	AFL7810W-30N50-B



W system	lm system	optics	code
12W	689	15°	AFL7812W-30N15-B
12W	671	24°	AFL7812W-30N24-B
12W	618	36°	AFL7812W-30N36-B
12W	598	50°	AFL7812W-30N50-B

ACME STRAIGHT

Φ78 Engine

Trimless Adjustable Round Downlight



view on website



cutout: 78mm



Adjustable Optic

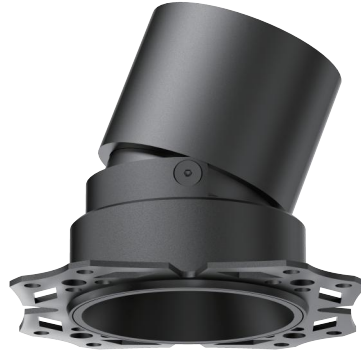

baffle



Black Painted
9005

White Painted
9016

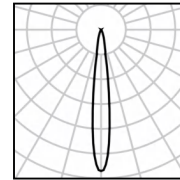
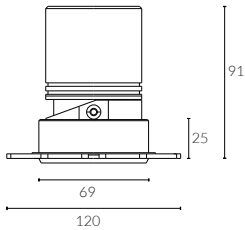

12W Ra98 3000K 15°

h(m)	E(lx)	D(m)
0.5	18360	0.13
1.0	4590	0.26
1.5	2040	0.39
2.0	1148	0.52
2.5	734	0.65
3.0	510	0.78

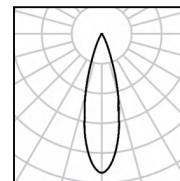

12W Ra98 3000K 24°

h(m)	E(lx)	D(m)
0.5	6420	0.22
1.0	1605	0.44
1.5	713	0.65
2.0	401	0.87
2.5	257	1.09
3.0	178	1.31

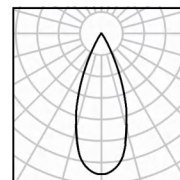

12W Ra98 3000K 36°

h(m)	E(lx)	D(m)
0.5	2791	0.31
1.0	698	0.62
1.5	310	0.93
2.0	174	1.25
2.5	112	1.56
3.0	78	1.87

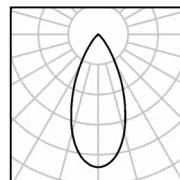

12W Ra98 3000K 50°

h(m)	E(lx)	D(m)
0.5	1324	0.52
1.0	331	1.03
1.5	147	1.55
2.0	83	2.06
2.5	53	2.58
3.0	37	3.10

IP Rating:	IP20 and IP44 options
Optics:	15°/24°/36°/50°
UGR:	< 10
CRI:	98Ra
Lifetime:	> 50,000 hrs (L70 B10)
CCT:	2700K/3000K/3500K/4000K/5000K/ 2000K-3000K/1800K-4000K/2700K-6000K

Typical Source Efficacy (lm/W):	110
Control:	On/off, Mains Dim, 0/1-10V, Dali, Zigbee, Casambi
Binning:	2 Step MacAdams
Input:	AC220-240V 50/60Hz
Output:	DC 36V 200mA 8W DC 36V 250mA 10W DC 36V 300mA 12W

Ambient temp:	-20 °C to 45 °C
Class:	II
Optional accessories:	Honeycomb louvre, Solite Lense, Spread Lense, Colour Filter

Material:	Fine aluminium 6063A
Fire resistance test:	60 minutes



DuraGreen project:
Covent Garden, Londoner Hotel

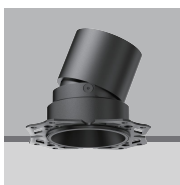

W system	lm system	optics	code
8W	450	15°	AFL7808W-TL-30N15
8W	442	24°	AFL7808W-TL-30N24
8W	397	36°	AFL7808W-TL-30N36
8W	327	50°	AFL7808W-TL-30N50

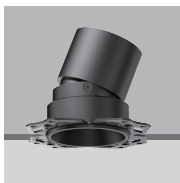

W system	lm system	optics	code
10W	580	15°	AFL7810W-TL-30N15
10W	563	24°	AFL7810W-TL-30N24
10W	519	36°	AFL7810W-TL-30N36
10W	500	50°	AFL7810W-TL-30N50



W system	lm system	optics	code
12W	689	15°	AFL7812W-TL-30N15
12W	671	24°	AFL7812W-TL-30N24
12W	618	36°	AFL7812W-TL-30N36
12W	598	50°	AFL7812W-TL-30N50

ACME STRAIGHT

Φ78 Engine Fixed Round Downlight



view on website



cutout: 78mm



Fixed Optic

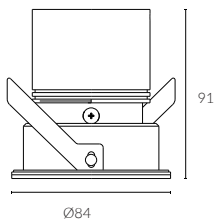

bezel | baffle

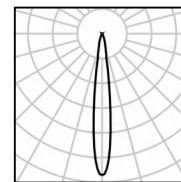

h(m)	E lx	D(m)
0.5	18360	0.13
1.0	4590	0.26
1.5	2040	0.39
2.0	1148	0.52
2.5	734	0.65
3.0	510	0.78

12W Ra98 3000K 15°

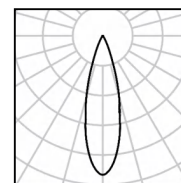

h(m)	E lx	D(m)
0.5	6420	0.22
1.0	1605	0.44
1.5	713	0.65
2.0	401	0.87
2.5	257	1.09
3.0	178	1.31

12W Ra98 3000K 24°

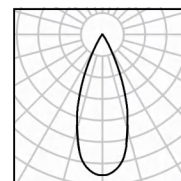

h(m)	E lx	D(m)
0.5	2791	0.31
1.0	698	0.62
1.5	310	0.93
2.0	174	1.25
2.5	112	1.56
3.0	78	1.87

12W Ra98 3000K 36°

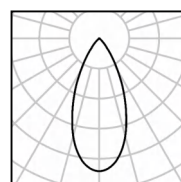

h(m)	E lx	D(m)
0.5	1324	0.52
1.0	331	1.03
1.5	147	1.55
2.0	83	2.06
2.5	53	2.58
3.0	37	3.10

12W Ra98 3000K 50°

IP Rating:	IP20 and IP44 options
Optics:	15°/24°/36°/50°
UGR:	< 10
CRI:	98Ra
Lifetime:	>50,000 hrs (L70 B10)
CCT:	2700K/3000K/3500K/4000K/5000K/ 2000K-3000K/1800K-4000K/2700K-6000K

Typical Source	
Efficacy (lm/W):	110
Control:	On/off, Mains Dim, 0/1-10V, Dali, Zigbee, Casambi
Binning	2 Step MacAdams
Input:	AC220-240V 50/60Hz
Output:	DC 36V 200mA 8W DC 36V 250mA 10W DC 36V 300mA 12W

Ambient temp:	-20 °C to 45 °C
Class:	II
Optional accessories:	Honeycomb louvre, Solite Lense, Spread Lense, Colour Filter

Ceiling Thickness:	9mm-28mm
Material:	Fine aluminium 6063A
Fire resistance test:	60 minutes



DuraGreen project:
CIVRO Showroom



W system	lm system	optics	code
8W	450	15°	MFL7808W-30N15-B
8W	442	24°	MFL7808W-30N24-B
8W	397	36°	MFL7808W-30N36-B
8W	327	50°	MFL7808W-30N50-B



W system	lm system	optics	code
10W	580	15°	MFL7810W-30N15-B
10W	563	24°	MFL7810W-30N24-B
10W	519	36°	MFL7810W-30N36-B
10W	500	50°	MFL7810W-30N50-B



W system	lm system	optics	code
12W	689	15°	MFL7812W-30N15-B
12W	671	24°	MFL7812W-30N24-B
12W	618	36°	MFL7812W-30N36-B
12W	598	50°	MFL7812W-30N50-B

ACME STRAIGHT

Φ78 Engine

Trimless Fixed Round Downlight



view on website



cutout: 78mm



Fixed Optic



baffle



Black Painted
9005



White Painted
9016

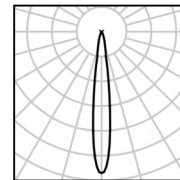
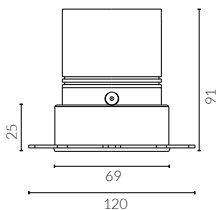

12W Ra98 3000K 15°

h(m)	E(lx)	D(m)
0.5	18360	0.13
1.0	4590	0.26
1.5	2040	0.39
2.0	1148	0.52
2.5	734	0.65
3.0	510	0.78

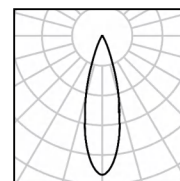

12W Ra98 3000K 24°

h(m)	E(lx)	D(m)
0.5	6420	0.22
1.0	1605	0.44
1.5	713	0.65
2.0	401	0.87
2.5	257	1.09
3.0	178	1.31

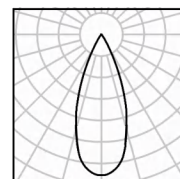

12W Ra98 3000K 36°

h(m)	E(lx)	D(m)
0.5	2791	0.31
1.0	698	0.62
1.5	310	0.93
2.0	174	1.25
2.5	112	1.56
3.0	78	1.87

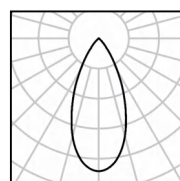

12W Ra98 3000K 50°

h(m)	E(lx)	D(m)
0.5	1324	0.52
1.0	331	1.03
1.5	147	1.55
2.0	83	2.06
2.5	53	2.58
3.0	37	3.10

- IP Rating:** IP20 and IP44 options
- Optics:** 15°/24°/36°/50°
- UGR:** <10
- CRI:** 98Ra
- Lifetime:** >50,000 hrs (L70 B10)
- CCT:** 2700K/3000K/3500K/4000K/5000K/
2000K-3000K/1800K-4000K/2700K-6000K
- Typical Source Efficacy (lm/W):** 110
- Control:** On/off, Mains Dim, 0/1-10V, Dali, Zigbee, Casambi
- Binning:** 2 Step MacAdams
- Input:** AC220-240V 50/60Hz
- Output:** DC 36V 200mA 8W
DC 36V 250mA 10W
DC 36V 300mA 12W
- Ambient temp:** -20 °C to 45 °C
- Class:** II
- Optional accessories:** Honeycomb louvre, Solite Lense, Spread Lense, Colour Filter
- Material:** Fine aluminium 6063A
- Fire resistance test:** 60 minutes



W system	lm system	optics	code
8W	450	15°	MFL7808W-TL-30N15
8W	442	24°	MFL7808W-TL-30N24
8W	397	36°	MFL7808W-TL-30N36
8W	327	50°	MFL7808W-TL-30N50



W system	lm system	optics	code
10W	580	15°	MFL7810W-TL-30N15
10W	563	24°	MFL7810W-TL-30N24
10W	519	36°	MFL7810W-TL-30N36
10W	500	50°	MFL7810W-TL-30N50



W system	lm system	optics	code
12W	689	15°	MFL7812W-TL-30N15
12W	671	24°	MFL7812W-TL-30N24
12W	618	36°	MFL7812W-TL-30N36
12W	598	50°	MFL7812W-TL-30N50

ACME CURVE

Φ50 Engine Curve Adjustable Round Downlight



view on website



cutout: 50mm



Adjustable Optic

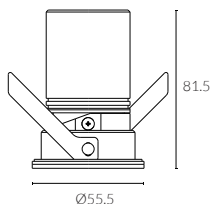

Curve baffle for soft and subtle beams

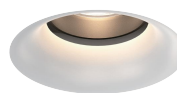

bezel | baffle



Black Painted 9005



White Painted 9016



Solid Brass



Antique Bronze



Black Nickel



Brushed Grey



Polished Chrome

IP Rating:	IP20 and IP44 options
Optics:	15°/24°/36°
UGR:	< 10
CRI:	98Ra
Lifetime:	> 50,000 hrs (L70 B10)
CCT:	2700K/3000K/3500K/4000K/5000K/2000K-3000K 1800K-4000K/2700K-6000K

Typical Source	
Efficacy (lm/W):	110
Control:	On/off, Mains Dim, 0/1-10V, Dali, Zigbee, Casambi
Binning	2 Step MacAdams
Input:	AC220-240V 50/60Hz
Output:	DC 36V 100mA 4W DC 36V 150mA 6W DC 36V 200mA 8W

Ambient temp:	-20 °C to 45 °C
Class:	II
Optional accessories:	Honeycomb louvre, Solite Lense, Spread Lense, Colour Filter

Ceiling Thickness:	9mm-28mm
Material:	Fine aluminium 6063A
Fire resistance test:	60 minutes

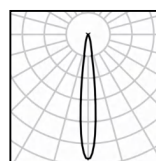

8W Ra98 3000K 15°

h(m)	E(lx)	D(m)
0.5	7204	0.11
1.0	1801	0.22
1.5	800	0.33
2.0	450	0.43
2.5	288	0.54
3.0	200	0.65

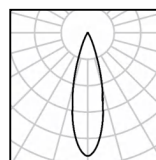

8W Ra98 3000K 24°

h(m)	E(lx)	D(m)
0.5	2613	0.25
1.0	653	0.49
1.5	290	0.74
2.0	163	0.99
2.5	105	1.24
3.0	73	1.48

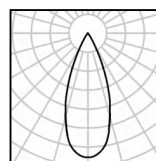

8W Ra98 3000K 36°

h(m)	E(lx)	D(m)
0.5	2005	0.34
1.0	501	0.68
1.5	223	1.03
2.0	125	1.37
2.5	80	1.71
3.0	56	2.05

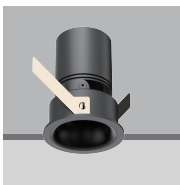

W System	Lm System	Optics	Code
4W	182	15°	AFL5004W-C-30N15-B
4W	205	24°	AFL5004W-C-30N24-B
4W	247	36°	AFL5004W-C-30N36-B

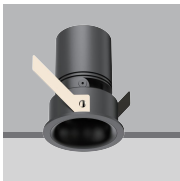

W System	Lm System	Optics	Code
6W	267	15°	AFL5006W-C-30N15-B
6W	306	24°	AFL5006W-C-30N24-B
6W	368	36°	AFL5006W-C-30N36-B



W System	Lm System	Optics	Code
8W	336	15°	AFL5008W-C-30N15-B
8W	381	24°	AFL5008W-C-30N24-B
8W	453	36°	AFL5008W-C-30N36-B

ACME CURVE

Φ50 Engine Curve Trimless Adjustable Round Downlight



view on website



cutout:50mm



Adjustable Optic



360°

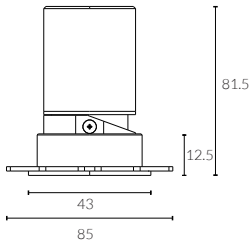
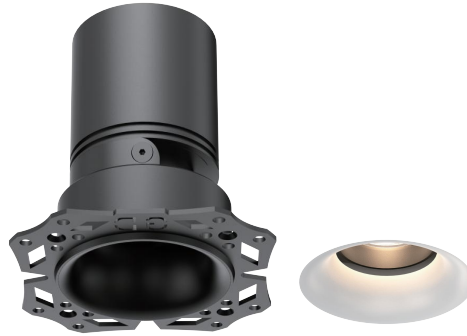

baffle



- IP Rating:** IP20 and IP44 options
- Optics:** 15°/24°/36°
- UGR:** < 10
- CRI:** 98Ra
- Lifetime:** >50,000 hrs (L70 B10)
- CCT:** 2700K/3000K/3500K/4000K/5000K/
2000K-3000K/1800K-4000K/2700K-6000K

- Typical Source Efficacy (lm/W):** 110
- Control:** On/off, Mains Dim, 0/1-10V, Dali, Zigbee, Casambi
- Binning:** 2 Step MacAdams
- Input:** AC220-240V 50/60Hz
- Output:** DC 36V 100mA 4W
DC 36V 150mA 6W
DC 36V 200mA 8W

- Ambient temp:** -20 °C to 45 °C
- Class:** II
- Optional accessories:** Honeycomb louvre, Solite Lense, Spread Lense, Colour Filter

- Material:** Fine aluminium 6063A
- Fire resistance test:** 60 minutes

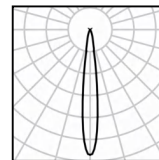

8W Ra98 3000K 15°

h(m)	E(lx)	D(m)
0.5	7204	0.11
1.0	1801	0.22
1.5	800	0.33
2.0	450	0.43
2.5	288	0.54
3.0	200	0.65

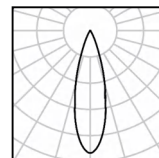

8W Ra98 3000K 24°

h(m)	E(lx)	D(m)
0.5	2613	0.25
1.0	653	0.49
1.5	290	0.74
2.0	163	0.99
2.5	105	1.24
3.0	73	1.48

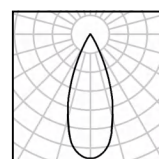

8W Ra98 3000K 36°

h(m)	E(lx)	D(m)
0.5	2005	0.34
1.0	501	0.68
1.5	223	1.03
2.0	125	1.37
2.5	80	1.71
3.0	56	2.05



DuraGreen project:
Alacarte Halong Bay Condotel



W System	Lm System	Optics	Code
4W	182	15°	AFL5004W-C-TL-30N15
4W	205	24°	AFL5004W-C-TL-30N24
4W	247	36°	AFL5004W-C-TL-30N36

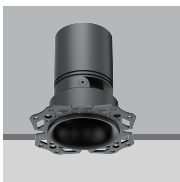

W System	Lm System	Optics	Code
6W	267	15°	AFL5006W-C-TL-30N15
6W	306	24°	AFL5006W-C-TL-30N24
6W	368	36°	AFL5006W-C-TL-30N36

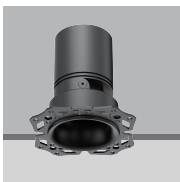

W System	Lm System	Optics	Code
8W	336	15°	AFL5008W-C-TL-30N15
8W	381	24°	AFL5008W-C-TL-30N24
8W	453	36°	AFL5008W-C-TL-30N36

ACME CURVE

Φ57 Engine Curve Adjustable Round Downlight



view on website



cutout: 57mm



Adjustable Optic

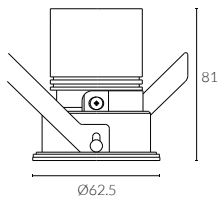
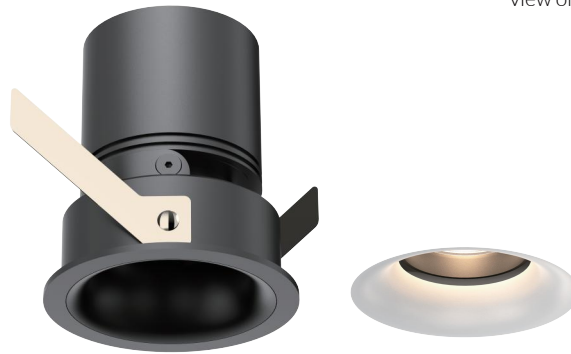

bezel | baffle



IP Rating:	IP20 and IP44 options
Optics:	15°/24°/36°
UGR:	< 10
CRI:	98Ra
Lifetime:	> 50,000 hrs (L70 B10)
CCT:	2700K/3000K/3500K/4000K/5000K/ 2000K-3000K/1800K-4000K/2700K-6000K

Typical Source	
Efficacy (lm/W):	110
Control:	On/off, Mains Dim, 0/1-10V, Dali, Zigbee, Casambi
Binning	2 Step MacAdams
Input:	AC220-240V 50/60Hz
Output:	DC 36V 150mA 6W DC 36V 200mA 8W DC 36V 250mA 10W

Ambient temp:	-20 °C to 45 °C
Class:	II
Optional accessories:	Honeycomb louvre, Solite Lens, Spread Lens, Colour Filter

Ceiling Thickness:	9mm-28mm
Material:	Fine aluminium 6063A
Fire resistance test:	60 minutes

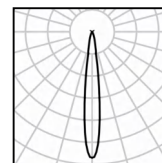

10W Ra98 3000K 15°

h(m)	E lx	D(m)
0.5	10728	0.15
1.0	2682	0.31
1.5	1192	0.46
2.0	671	0.61
2.5	429	0.77
3.0	298	0.92

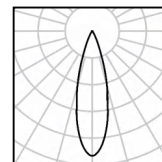

10W Ra98 3000K 24°

h(m)	E lx	D(m)
0.5	7580	0.21
1.0	1895	0.42
1.5	842	0.63
2.0	474	0.84
2.5	303	1.04
3.0	211	1.25

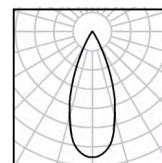

10W Ra98 3000K 36°

h(m)	E lx	D(m)
0.5	4206	0.28
1.0	1051	0.57
1.5	467	0.85
2.0	263	1.14
2.5	168	1.42
3.0	117	1.71



W system	lm system	optics	code
6W	367	15°	AFL5706W-C-30N15-B
6W	349	24°	AFL5706W-C-30N24-B
6W	340	36°	AFL5706W-C-30N36-B



W system	lm system	optics	code
8W	419	15°	AFL5708W-C-30N15-B
8W	470	24°	AFL5708W-C-30N24-B
8W	456	36°	AFL5708W-C-30N36-B



W system	lm system	optics	code
10W	462	15°	AFL5710W-C-30N15-B
10W	628	24°	AFL5710W-C-30N24-B
10W	616	36°	AFL5710W-C-30N36-B

ACME CURVE

Φ57 Engine Curve Trimless Adjustable Round Downlight



view on website



cutout:57mm



Adjustable Optic

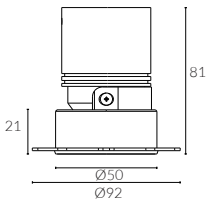

baffle



- IP Rating:** IP20 and IP44 options
- Optics:** 15°/24°/36°
- UGR:** <10
- CRI:** 98Ra
- Lifetime:** >50,000 hrs (L70 B10)
- CCT:** 2700K/3000K/3500K/4000K/5000K/
2000K-3000K/1800K-4000K/2700K-6000K

- Typical Source**
- Efficacy (lm/W):** 110
- Control:** On/off, Mains Dim, 0/1-10V, Dali, Zigbee, Casambi
- Binning** 2 Step MacAdams
- Input:** AC220-240V 50/60Hz
- Output:** DC 36V 150mA 6W
DC 36V 200mA 8W
DC 36V 250mA 10W

Ambient temp: -20 °C to 45 °C

Class: II

Optional accessories: Honeycomb louvre, Solite Lense, Spread Lense,
Colour Filter

Material: Fine aluminium 6063A

Fire resistance test: 60 minutes

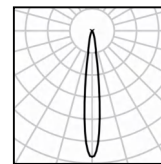

10W Ra98 3000K 15°

h(m)	E(lx)	D(m)
0.5	10728	0.15
1.0	2682	0.31
1.5	1192	0.46
2.0	671	0.61
2.5	429	0.77
3.0	298	0.92

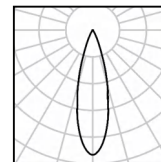

10W Ra98 3000K 24°

h(m)	E(lx)	D(m)
0.5	7580	0.21
1.0	1895	0.42
1.5	842	0.63
2.0	474	0.84
2.5	303	1.04
3.0	211	1.25

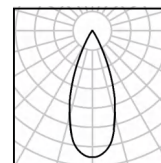

10W Ra98 3000K 36°

h(m)	E(lx)	D(m)
0.5	4206	0.28
1.0	1051	0.57
1.5	467	0.85
2.0	263	1.14
2.5	168	1.42
3.0	117	1.71



W system	lm system	optics	code
6W	367	15°	AFL5706W-C-TL-30N15-B
6W	349	24°	AFL5706W-C-TL-30N24-B
6W	340	36°	AFL5706W-C-TL-30N36-B



W system	lm system	optics	code
8W	419	15°	AFL5708W-C-TL-30N15-B
8W	470	24°	AFL5708W-C-TL-30N24-B
8W	456	36°	AFL5708W-C-TL-30N36-B



W system	lm system	optics	code
10W	462	15°	AFL5710W-C-TL-30N15-B
10W	628	24°	AFL5710W-C-TL-30N24-B
10W	616	36°	AFL5710W-C-TL-30N36-B

ACME CURVE

Φ68 Engine Curve Adjustable Round Downlight



view on website



cutout :68mm



Adjustable Optic

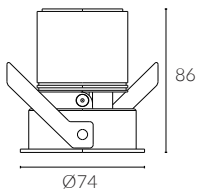
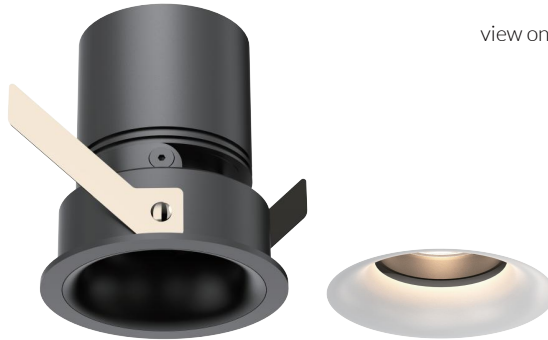

bezel | baffle



- IP Rating:** IP20 and IP44 options
- Optics:** 15°/24°/36°/50°
- UGR:** <10
- CRI:** 98Ra
- Lifetime:** >50,000 hrs (L70 B10)
- CCT:** 2700K/3000K/3500K/4000K/5000K/
2000K-3000K/1800K-4000K/2700K-6000K

- Typical Source**
- Efficacy (lm/W):** 110
- Control:** On/off, Mains Dim, 0/1-10V, Dali, Zigbee, Casambi
- Binning** 2 Step MacAdams
- Input:** AC220-240V 50/60Hz
- Output:** DC 36V 200mA 8W
DC 36V 250mA 10W
DC 36V 300mA 12W
- Ambient temp:** -20 °C to 45 °C
- Class:** II

Optional accessories: Honeycomb louvre, Solite Lense, Spread Lense, Colour Filter

- Ceiling Thickness:** 9mm-28mm
- Material:** Fine aluminium 6063A
- Fire resistance test:** 60 minutes

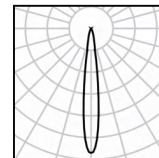

12W Ra98 3000K 15°

h(m)	E(lx)	D(m)
0.5	10897	0.17
1.0	2724	0.33
1.5	1211	0.50
2.0	681	0.66
2.5	436	0.83
3.0	303	0.99

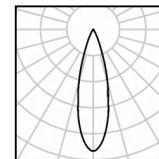

12W Ra98 3000K 24°

h(m)	E(lx)	D(m)
0.5	8621	0.20
1.0	2155	0.41
1.5	958	0.61
2.0	539	0.81
2.5	345	1.02
3.0	239	1.22

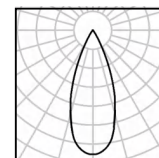

12W Ra98 3000K 36°

h(m)	E(lx)	D(m)
0.5	4792	0.28
1.0	1198	0.55
1.5	532	0.83
2.0	300	1.10
2.5	192	1.38
3.0	133	1.65

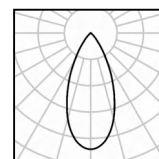

12W Ra98 3000K 50°

h(m)	E(lx)	D(m)
0.5	1608	0.47
1.0	402	0.93
1.5	179	1.40
2.0	100	1.87
2.5	64	2.33
3.0	45	2.80



DuraGreen project:
Home Cinema London



W system	lm system	optics	code
8W	508	15°	AFL6808W-C-30N15-B
8W	486	24°	AFL6808W-C-30N24-B
8W	474	36°	AFL6808W-C-30N36-B
8W	406	50°	AFL6808W-C-30N50-B



W system	lm system	optics	code
10W	559	15°	AFL6810W-C-30N15-B
10W	548	24°	AFL6810W-C-30N24-B
10W	529	36°	AFL6810W-C-30N36-B
10W	434	50°	AFL6810W-C-30N50-B



W system	lm system	optics	code
12W	648	15°	AFL6812W-C-30N15-B
12W	636	24°	AFL6812W-C-30N24-B
12W	624	36°	AFL6812W-C-30N36-B
12W	583	50°	AFL6812W-C-30N50-B

ACME CURVE

Φ68 Engine Curve

Trimless Adjustable Round Downlight



view on website



cutout :68mm



Adjustable Optic

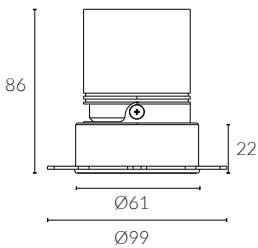

baffle



Black Painted 9005



White Painted 9016



Solid Brass



Antique Bronze



Black Nickel



Brushed Grey



Polished Chrome

- IP Rating:** IP20 and IP44 options
- Optics:** 15°/24°/36°/50°
- UGR:** <10
- CRI:** 98Ra
- Lifetime:** >50,000 hrs (L70 B10)
- CCT:** 2700K/3000K/3500K/4000K/5000K/
2000K-3000K/1800K-4000K/2700K-6000K
- Typical Source Efficacy (lm/W):** 110
- Control:** On/off, Mains Dim, 0/1-10V, Dali, Zigbee, Casambi
- Binning:** 2 Step MacAdams
- Input:** AC220-240V 50/60Hz
- Output:** DC 36V 200mA 8W
DC 36V 250mA 10W
DC 36V 300mA 12W
- Ambient temp:** -20 °C to 45 °C
- Class:** II
- Optional accessories:** Honeycomb louvre, Solite Lens, Spread Lens, Colour Filter
- Material:** Fine aluminium 6063A
- Fire resistance test:** 60 minutes

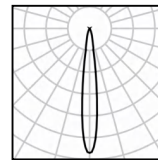

12W Ra98 3000K 15°

h(m)	E(lx)	D(m)
0.5	10897	0.17
1.0	2724	0.33
1.5	1211	0.50
2.0	681	0.66
2.5	436	0.83
3.0	303	0.99

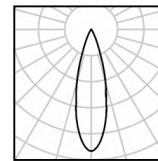

12W Ra98 3000K 24°

h(m)	E(lx)	D(m)
0.5	8621	0.20
1.0	2155	0.41
1.5	958	0.61
2.0	539	0.81
2.5	345	1.02
3.0	239	1.22

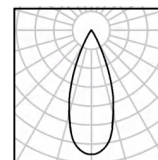

12W Ra98 3000K 36°

h(m)	E(lx)	D(m)
0.5	4792	0.28
1.0	1198	0.55
1.5	532	0.83
2.0	300	1.10
2.5	192	1.38
3.0	133	1.65

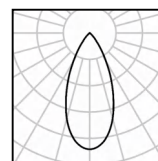

12W Ra98 3000K 50°

h(m)	E(lx)	D(m)
0.5	1608	0.47
1.0	402	0.93
1.5	179	1.40
2.0	100	1.87
2.5	64	2.33
3.0	45	2.80



W system	lm system	optics	code
8W	508	15°	AFL6808W-C-TL-30N15-B
8W	486	24°	AFL6808W-C-TL-30N24-B
8W	474	36°	AFL6808W-C-TL-30N36-B
8W	406	50°	AFL6808W-C-TL-30N50-B



W system	lm system	optics	code
10W	559	15°	AFL6810W-C-TL-30N15-B
10W	548	24°	AFL6810W-C-TL-30N24-B
10W	529	36°	AFL6810W-C-TL-30N36-B
10W	434	50°	AFL6810W-C-TL-30N50-B



W system	lm system	optics	code
12W	648	15°	AFL6812W-C-TL-30N15-B
12W	636	24°	AFL6812W-C-TL-30N24-B
12W	624	36°	AFL6812W-C-TL-30N36-B
12W	583	50°	AFL6812W-C-TL-30N50-B

ACME CURVE

Φ78 Engine Curve Adjustable Round Downlight



view on website



cutout: 78mm



Adjustable Optic

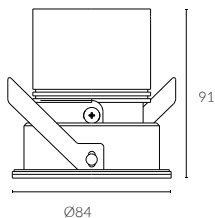
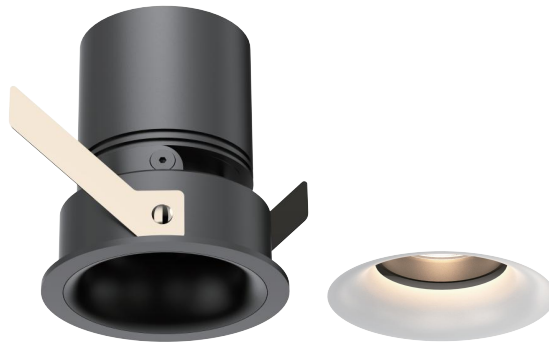

bezel | baffle



- IP Rating:** IP20 and IP44 options
- Optics:** 15°/24°/36°/50°
- UGR:** < 10
- CRI:** 98Ra
- Lifetime:** > 50,000 hrs (L70 B10)
- CCT:** 2700K/3000K/3500K/4000K/5000K/
2000K-3000K/1800K-4000K/2700K-6000K

- Typical Source Efficacy (lm/W):** 110
- Control:** On/off, Mains Dim, 0/1-10V, Dali, Zigbee, Casambi
- Binning:** 2 Step MacAdams
- Input:** AC220-240V 50/60Hz
- Output:** DC 36V 200mA 8W
DC 36V 250mA 10W
DC 36V 300mA 12W

- Ambient temp:** -20 °C to 45 °C
- Class:** II
- Optional accessories:** Honeycomb louvre, Solite Lense, Spread Lense,
Colour Filter

- Ceiling Thickness:** 9mm-28mm
- Material:** Fine aluminium 6063A
- Fire resistance test:** 60 minutes

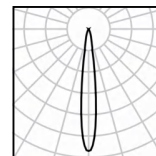

12W Ra98 3000K 15°

h(m)	E(lx)	D(m)
0.5	18360	0.13
1.0	4590	0.26
1.5	2040	0.39
2.0	1148	0.52
2.5	734	0.65
3.0	510	0.78

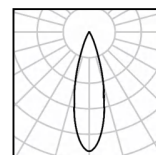

12W Ra98 3000K 24°

h(m)	E(lx)	D(m)
0.5	6420	0.22
1.0	1605	0.44
1.5	713	0.65
2.0	401	0.87
2.5	257	1.09
3.0	178	1.31

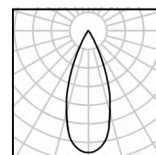

12W Ra98 3000K 36°

h(m)	E(lx)	D(m)
0.5	2791	0.31
1.0	698	0.62
1.5	310	0.93
2.0	174	1.25
2.5	112	1.56
3.0	78	1.87

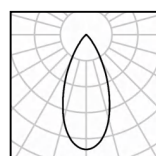

12W Ra98 3000K 50°

h(m)	E(lx)	D(m)
0.5	1324	0.52
1.0	331	1.03
1.5	147	1.55
2.0	83	2.06
2.5	53	2.58
3.0	37	3.10



W system	lm system	optics	code
8W	450	15°	AFL7808W-C-30N15-B
8W	442	24°	AFL7808W-C-30N24-B
8W	397	36°	AFL7808W-C-30N36-B
8W	327	50°	AFL7808W-C-30N50-B



W system	lm system	optics	code
10W	580	15°	AFL7810W-C-30N15-B
10W	563	24°	AFL7810W-C-30N24-B
10W	519	36°	AFL7810W-C-30N36-B
10W	500	50°	AFL7810W-C-30N50-B



W system	lm system	optics	code
12W	689	15°	AFL7812W-C-30N15-B
12W	671	24°	AFL7812W-C-30N24-B
12W	618	36°	AFL7812W-C-30N36-B
12W	598	50°	AFL7812W-C-30N50-B

ACME CURVE

Φ78 Engine Curve Trimless Adjustable Round Downlight



view on website



cutout: 78mm



Adjustable Optic

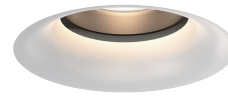

baffle



Black Painted
9005



White Painted
9016



Solid Brass



Antique Bronze



Black Nickel



Brushed Grey



Polished Chrome

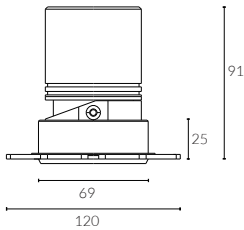

- IP Rating:** IP20 and IP44 options
- Optics:** 15°/24°/36°/50°
- UGR:** <10
- CRI:** 98Ra
- Lifetime:** >50,000 hrs (L70 B10)
- CCT:** 2700K/3000K/3500K/4000K/5000K/
2000K-3000K/1800K-4000K/2700K-6000K
- Typical Source Efficacy (lm/W):** 110
- Control:** On/off, Mains Dim, 0/1-10V, Dali, Zigbee, Casambi
- Binning:** 2 Step MacAdams
- Input:** AC220-240V 50/60Hz
- Output:** DC 36V 200mA 8W
DC 36V 250mA 10W
DC 36V 300mA 12W
- Ambient temp:** -20 °C to 45 °C
- Class:** II
- Optional accessories:** Honeycomb louvre, Solite Lense, Spread Lense,
Colour Filter
- Material:** Fine aluminium 6063A
- Fire resistance test:** 60 minutes

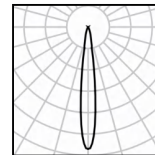

12W Ra98 3000K 15°

h(m)	E(lx)	D(m)
0.5	18360	0.13
1.0	4590	0.26
1.5	2040	0.39
2.0	1148	0.52
2.5	734	0.65
3.0	510	0.78

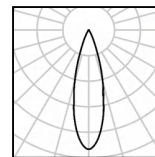

12W Ra98 3000K 24°

h(m)	E(lx)	D(m)
0.5	6420	0.22
1.0	1605	0.44
1.5	713	0.65
2.0	401	0.87
2.5	257	1.09
3.0	178	1.31

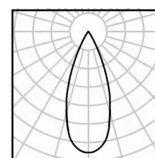

12W Ra98 3000K 36°

h(m)	E(lx)	D(m)
0.5	2791	0.31
1.0	698	0.62
1.5	310	0.93
2.0	174	1.25
2.5	112	1.56
3.0	78	1.87

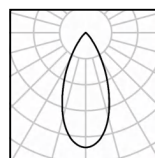

12W Ra98 3000K 50°

h(m)	E(lx)	D(m)
0.5	1324	0.52
1.0	331	1.03
1.5	147	1.55
2.0	83	2.06
2.5	53	2.58
3.0	37	3.10

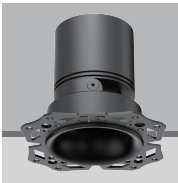

W system	lm system	optics	code
8W	450	15°	AFL7808W-C-TL-30N15
8W	442	24°	AFL7808W-C-TL-30N24
8W	397	36°	AFL7808W-C-TL-30N36
8W	327	50°	AFL7808W-C-TL-30N50



W system	lm system	optics	code
10W	580	15°	AFL7810W-C-TL-30N15
10W	563	24°	AFL7810W-C-TL-30N24
10W	519	36°	AFL7810W-C-TL-30N36
10W	500	50°	AFL7810W-C-TL-30N50



W system	lm system	optics	code
12W	689	15°	AFL7812W-C-TL-30N15
12W	671	24°	AFL7812W-C-TL-30N24
12W	618	36°	AFL7812W-C-TL-30N36
12W	598	50°	AFL7812W-C-TL-30N50

Φ50 Engine Semi-recessed Adjustable Round Downlight



cutout:50mm



Adjustable Optic

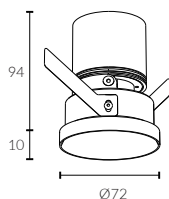

bezel | baffle



IP Rating: IP20 and IP44 options
Optics: 15°/24°/36°
UGR: < 10
CRI: 98Ra
Lifetime: > 50,000 hrs (L70 B10)
CCT: 2700K/3000K/3500K/4000K/5000K/
 2000K-3000K/1800K-4000K/2700K-6000K

Typical Source Efficacy (lm/W): 110
Control: On/off, Mains Dim, 0/1-10V, Dali, Zigbee, Casambi
Binning: 2 Step MacAdams
Input: AC220-240V 50/60Hz
Output: DC 36V 100mA 4W
 DC 36V 150mA 6W
 DC 36V 200mA 8W

Ambient temp: -20 °C to 45 °C
Class: II

Optional accessories: Honeycomb louvre, Solite Lense, Spread Lense, Colour Filter

Ceiling Thickness: 9mm-28mm
Material: Fine aluminium 6063A
Fire resistance test: 60 minutes

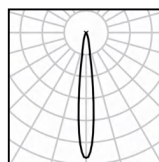

8W Ra98 3000K 15°

h(m)	E(lx)	D(m)
0.5	7204	0.11
1.0	1801	0.22
1.5	800	0.33
2.0	450	0.43
2.5	288	0.54
3.0	200	0.65

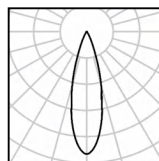

8W Ra98 3000K 24°

h(m)	E(lx)	D(m)
0.5	2613	0.25
1.0	653	0.49
1.5	290	0.74
2.0	163	0.99
2.5	105	1.24
3.0	73	1.48

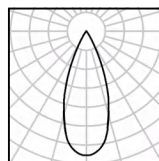

8W Ra98 3000K 36°

h(m)	E(lx)	D(m)
0.5	2005	0.34
1.0	501	0.68
1.5	223	1.03
2.0	125	1.37
2.5	80	1.71
3.0	56	2.05



W System	Lm System	Optics	Code
4W	182	15°	AFL5004W-M-30N15-B
4W	205	24°	AFL5004W-M-30N24-B
4W	247	36°	AFL5004W-M-30N36-B

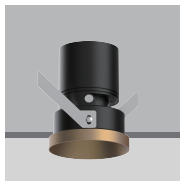

W System	Lm System	Optics	Code
6W	267	15°	AFL5006W-M-30N15-B
6W	306	24°	AFL5006W-M-30N24-B
6W	368	36°	AFL5006W-M-30N36-B

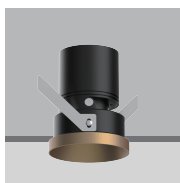

W System	Lm System	Optics	Code
8W	336	15°	AFL5008W-M-30N15-B
8W	381	24°	AFL5008W-M-30N24-B
8W	453	36°	AFL5008W-M-30N36-B

ACME SEMI

Φ50 Engine Semi-recessed Trimless Adjustable Round Downlight



view on website



cutout:50mm



Adjustable Optic

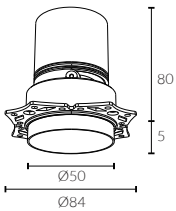

baffle



IP Rating: IP20 and IP44 options
Optics: 15°/24°/36°
UGR: < 10
CRI: 98Ra
Lifetime: >50,000 hrs (L70 B10)
CCT: 2700K/3000K/3500K/4000K/5000K/
 2000K-3000K/1800K-4000K/2700K-6000K

Typical Source Efficacy (lm/W): 110
Control: On/off, Mains Dim, 0/1-10V, Dali, Zigbee, Casambi
Binning: 2 Step MacAdams
Input: AC220-240V 50/60Hz
Output: DC 36V 100mA 4W
 DC 36V 150mA 6W
 DC 36V 200mA 8W

Ambient temp: -20 °C to 45 °C
Class: II
Optional accessories: Honeycomb louvre, Solite Lense, Spread Lense, Colour Filter

Material: Fine aluminium 6063A
Fire resistance test: 60 minutes

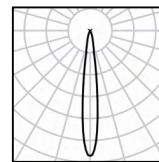

8W Ra98 3000K 15°

h(m)	E(lx)	D(m)
0.5	7204	0.11
1.0	1801	0.22
1.5	800	0.33
2.0	450	0.43
2.5	288	0.54
3.0	200	0.65

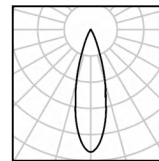

8W Ra98 3000K 24°

h(m)	E(lx)	D(m)
0.5	2613	0.25
1.0	653	0.49
1.5	290	0.74
2.0	163	0.99
2.5	105	1.24
3.0	73	1.48

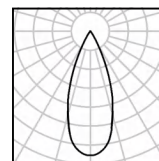

8W Ra98 3000K 36°

h(m)	E(lx)	D(m)
0.5	2005	0.34
1.0	501	0.68
1.5	223	1.03
2.0	125	1.37
2.5	80	1.71
3.0	56	2.05

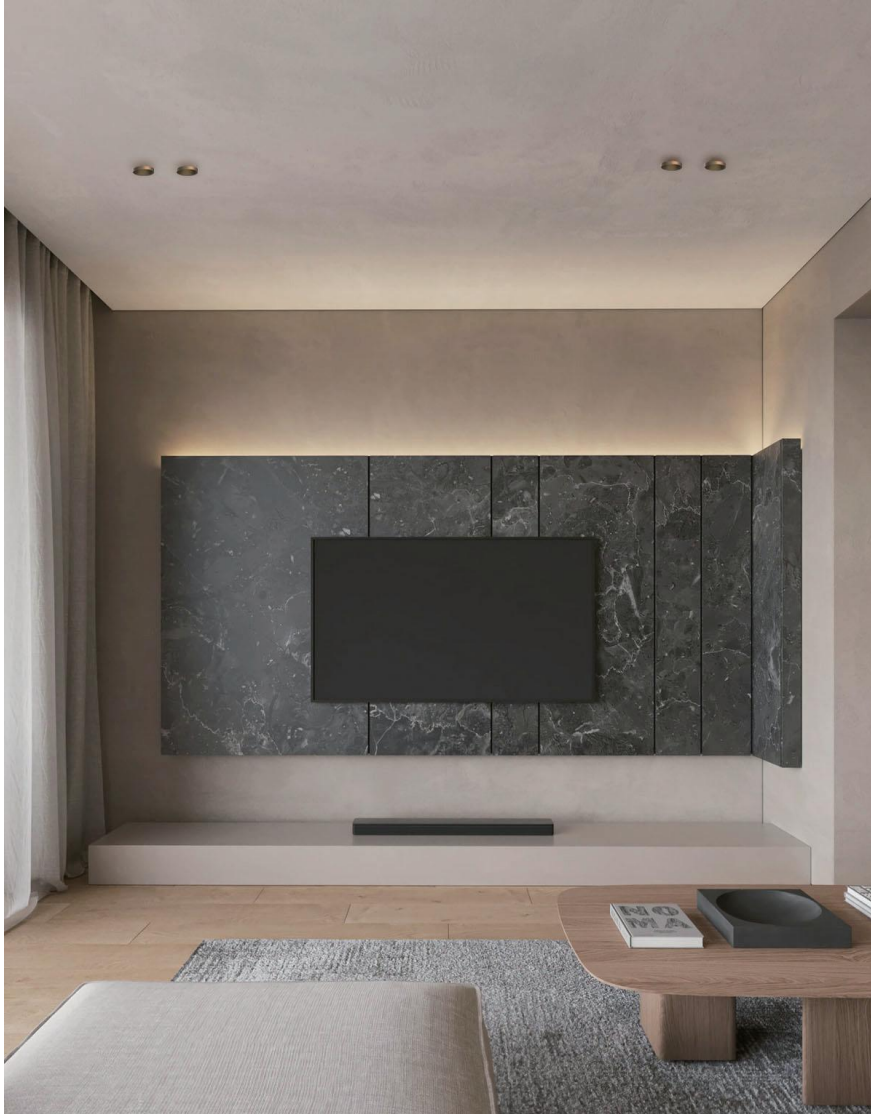

W System	Lm System	Optics	Code
4W	182	15°	AFL5004W-M-TL-30N15
4W	205	24°	AFL5004W-M-TL-30N24
4W	247	36°	AFL5004W-M-TL-30N36



W System	Lm System	Optics	Code
6W	267	15°	AFL5006W-M-TL-30N15
6W	306	24°	AFL5006W-M-TL-30N24
6W	368	36°	AFL5006W-M-TL-30N36



W System	Lm System	Optics	Code
8W	336	15°	AFL5008W-M-TL-30N15
8W	381	24°	AFL5008W-M-TL-30N24
8W	453	36°	AFL5008W-M-TL-30N36

Φ57 Engine Semi-recessed Adjustable Round Downlight



cutout:57mm



Adjustable Optic

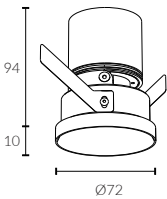

bezel | baffle



- IP Rating:** IP20 and IP44 options
- Optics:** 15°/24°/36°
- UGR:** < 10
- CRI:** 98Ra
- Lifetime:** >50,000 hrs (L70 B10)
- CCT:** 2700K/3000K/3500K/4000K/5000K/
2000K-3000K/1800K-4000K/2700K-6000K

- Typical Source Efficacy (lm/W):** 110
- Control:** On/off, Mains Dim, 0/1-10V, Dali, Zigbee, Casambi
- Binning:** 2 Step MacAdams
- Input:** AC220-240V 50/60Hz
- Output:** DC 36V 150mA 6W
DC 36V 200mA 8W
DC 36V 250mA 10W
- Ambient temp:** -20 C to 45 C
- Class:** II
- Optional accessories:** Honeycomb louvre, Solite Lense, Spread Lense, Colour Filter

- Ceiling Thickness:** 9mm-28mm
- Material:** Fine aluminium 6063A
- Fire resistance test:** 60 minutes

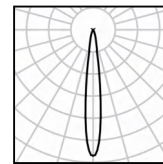

10W Ra98 3000K 15°

h(m)	E(lx)	D(m)
0.5	10728	0.15
1.0	2682	0.31
1.5	1192	0.46
2.0	671	0.61
2.5	429	0.77
3.0	298	0.92

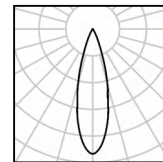

10W Ra98 3000K 24°

h(m)	E(lx)	D(m)
0.5	7580	0.21
1.0	1895	0.42
1.5	842	0.63
2.0	474	0.84
2.5	303	1.04
3.0	211	1.25

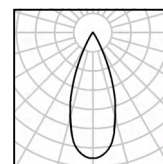

10W Ra98 3000K 36°

h(m)	E(lx)	D(m)
0.5	4206	0.28
1.0	1051	0.57
1.5	467	0.85
2.0	263	1.14
2.5	168	1.42
3.0	117	1.71



W system	lm system	optics	code
6W	367	15°	AFL5706W-M-30N15-B
6W	349	24°	AFL5706W-M-30N24-B
6W	340	36°	AFL5706W-M-30N36-B

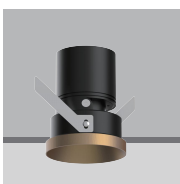

W system	lm system	optics	code
8W	419	15°	AFL5708W-M-30N15-B
8W	470	24°	AFL5708W-M-30N24-B
8W	456	36°	AFL5708W-M-30N36-B

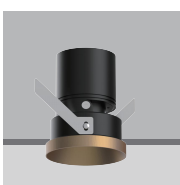

W system	lm system	optics	code
10W	462	15°	AFL5710W-M-30N15-B
10W	628	24°	AFL5710W-M-30N24-B
10W	616	36°	AFL5710W-M-30N36-B

ACME SEMI

Φ57 Engine Semi-recessed Trimless Adjustable Round Downlight



view on website



cutout:57mm



Adjustable Optic

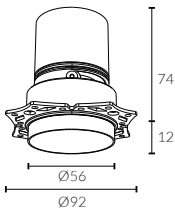

baffle



IP Rating: IP20 and IP44 options
Optics: 15°/24°/36°
UGR: < 10
CRI: 98Ra
Lifetime: > 50,000 hrs (L70 B10)
CCT: 2700K/3000K/3500K/4000K/5000K/
 2000K-3000K/1800K-4000K/2700K-6000K

Typical Source
Efficacy (lm/W): 110
Control: On/off, Mains Dim, 0/1-10V, Dali, Zigbee, Casambi
Binning 2 Step MacAdams
Input: AC220-240V 50/60Hz
Output: DC 36V 150mA 6W
 DC 36V 200mA 8W
 DC 36V 250mA 10W

Ambient temp: -20 °C to 45 °C

Class: II

Optional accessories: Honeycomb louvre, Solite Lense, Spread Lense,
 Colour Filter

Material: Fine aluminium 6063A

Fire resistance test: 60 minutes

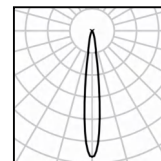

10W Ra98 3000K 15°

h(m)	E(lx)	D(m)
0.5	10728	0.15
1.0	2682	0.31
1.5	1192	0.46
2.0	671	0.61
2.5	429	0.77
3.0	298	0.92

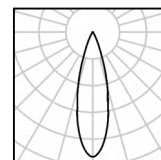

10W Ra98 3000K 24°

h(m)	E(lx)	D(m)
0.5	7580	0.21
1.0	1895	0.42
1.5	842	0.63
2.0	474	0.84
2.5	303	1.04
3.0	211	1.25

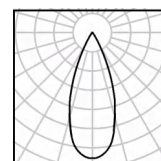

10W Ra98 3000K 36°

h(m)	E(lx)	D(m)
0.5	4206	0.28
1.0	1051	0.57
1.5	467	0.85
2.0	263	1.14
2.5	168	1.42
3.0	117	1.71

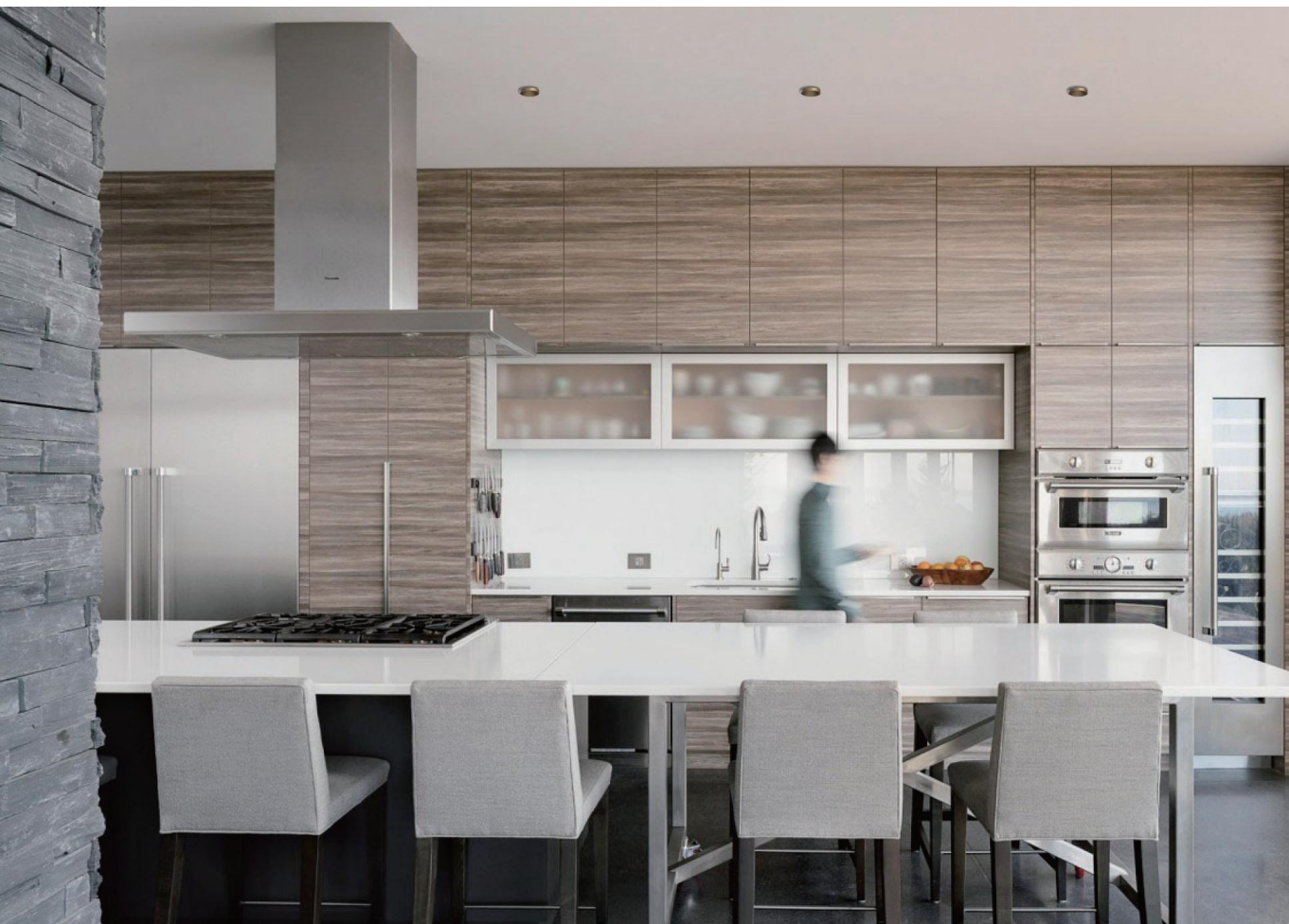

W system	lm system	optics	code
6W	367	15°	AFL5706W-M-TL-30N15-B
6W	349	24°	AFL5706W-M-TL-30N24-B
6W	340	36°	AFL5706W-M-TL-30N36-B



W system	lm system	optics	code
8W	419	15°	AFL5708W-M-TL-30N15-B
8W	470	24°	AFL5708W-M-TL-30N24-B
8W	456	36°	AFL5708W-M-TL-30N36-B



W system	lm system	optics	code
10W	462	15°	AFL5710W-M-TL-30N15-B
10W	628	24°	AFL5710W-M-TL-30N24-B
10W	616	36°	AFL5710W-M-TL-30N36-B

Φ68 Engine Semi-recessed Adjustable Round Downlight



cutout :68mm



Adjustable Optic

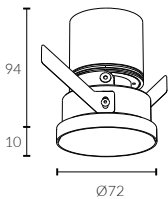

bezel | baffle



- IP Rating:** IP20 and IP44 options
- Optics:** 15°/24°/36°/50°
- UGR:** <10
- CRI:** 98Ra
- Lifetime:** >50,000 hrs (L70 B10)
- CCT:** 2700K/3000K/3500K/4000K/5000K/
2000K-3000K/1800K-4000K/2700K-6000K

- Typical Source Efficacy (lm/W):** 110
- Control:** On/off, Mains Dim, 0/1-10V, Dali, Zigbee, Casambi
- Binning:** 2 Step MacAdams
- Input:** AC220-240V 50/60Hz
- Output:** DC 36V 200mA 8W
DC 36V 250mA 10W
DC 36V 300mA 12W

- Ambient temp:** -20 °C to 45 °C
- Class:** II

- Optional accessories:** Honeycomb louvre, Solite Lense, Spread Lense, Colour Filter

- Ceiling Thickness:** 9mm-28mm
- Material:** Fine aluminium 6063A
- Fire resistance test:** 60 minutes

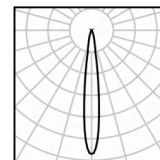

12W Ra98 3000K 15°

h(m)	E(lx)	D(m)
0.5	10897	0.17
1.0	2724	0.33
1.5	1211	0.50
2.0	681	0.66
2.5	436	0.83
3.0	303	0.99

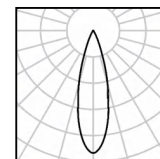

12W Ra98 3000K 24°

h(m)	E(lx)	D(m)
0.5	8621	0.20
1.0	2155	0.41
1.5	958	0.61
2.0	539	0.81
2.5	345	1.02
3.0	239	1.22

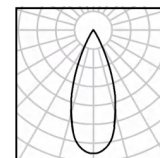

12W Ra98 3000K 36°

h(m)	E(lx)	D(m)
0.5	4792	0.28
1.0	1198	0.55
1.5	532	0.83
2.0	300	1.10
2.5	192	1.38
3.0	133	1.65

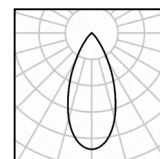

12W Ra98 3000K 50°

h(m)	E(lx)	D(m)
0.5	1608	0.47
1.0	402	0.93
1.5	179	1.40
2.0	100	1.87
2.5	64	2.33
3.0	45	2.80

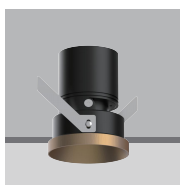

W system	lm system	optics	code
8W	508	15°	AFL6808W-M-30N15-B
8W	486	24°	AFL6808W-M-30N24-B
8W	474	36°	AFL6808W-M-30N36-B
8W	406	50°	AFL6808W-M-30N50-B

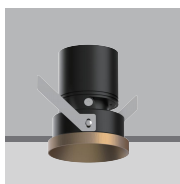

W system	lm system	optics	code
10W	559	15°	AFL6810W-M-30N15-B
10W	548	24°	AFL6810W-M-30N24-B
10W	529	36°	AFL6810W-M-30N36-B
10W	434	50°	AFL6810W-M-30N50-B

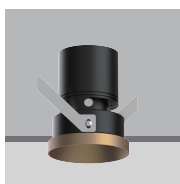

W system	lm system	optics	code
12W	648	15°	AFL6812W-M-30N15-B
12W	636	24°	AFL6812W-M-30N24-B
12W	624	36°	AFL6812W-M-30N36-B
12W	583	50°	AFL6812W-M-30N50-B

ACME SEMI

Φ68 Engine Semi-recessed Trimless Adjustable Round Downlight



view on website



cutout :68mm



Adjustable Optic

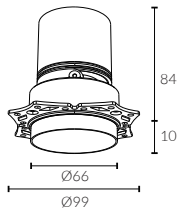

baffle



- IP Rating:** IP20 and IP44 options
- Optics:** 15°/24°/36°/50°
- UGR:** <10
- CRI:** 98Ra
- Lifetime:** >50,000 hrs (L70 B10)
- CCT:** 2700K/3000K/3500K/4000K/5000K/
2000K-3000K/1800K-4000K/2700K-6000K
- Typical Source Efficacy (lm/W):** 110
- Control:** On/off, Mains Dim, 0/1-10V, Dali, Zigbee, Casambi
- Binning** 2 Step MacAdams
- Input:** AC220-240V 50/60Hz
- Output:** DC 36V 200mA 8W
DC 36V 250mA 10W
DC 36V 300mA 12W
- Ambient temp:** -20 °C to 45 °C
- Class:** II
- Optional accessories:** Honeycomb louvre, Solite Lense, Spread Lense, Colour Filter
- Material:** Fine aluminium 6063A
- Fire resistance test:** 60 minutes

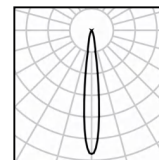

12W Ra98 3000K 15°

h(m)	E(lx)	D(m)
0.5	10897	0.17
1.0	2724	0.33
1.5	1211	0.50
2.0	681	0.66
2.5	436	0.83
3.0	303	0.99

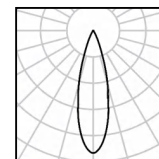

12W Ra98 3000K 24°

h(m)	E(lx)	D(m)
0.5	8621	0.20
1.0	2155	0.41
1.5	958	0.61
2.0	539	0.81
2.5	345	1.02
3.0	239	1.22

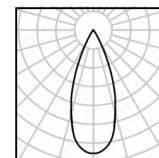

12W Ra98 3000K 36°

h(m)	E(lx)	D(m)
0.5	4792	0.28
1.0	1198	0.55
1.5	532	0.83
2.0	300	1.10
2.5	192	1.38
3.0	133	1.65

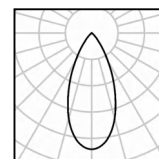

12W Ra98 3000K 50°

h(m)	E(lx)	D(m)
0.5	1608	0.47
1.0	402	0.93
1.5	179	1.40
2.0	100	1.87
2.5	64	2.33
3.0	45	2.80



W system	lm system	optics	code
8W	508	15°	AFL6808W-M-TL-30N15-B
8W	486	24°	AFL6808W-M-TL-30N24-B
8W	474	36°	AFL6808W-M-TL-30N36-B
8W	406	50°	AFL6808W-M-TL-30N50-B



W system	lm system	optics	code
10W	559	15°	AFL6810W-M-TL-30N15-B
10W	548	24°	AFL6810W-M-TL-30N24-B
10W	529	36°	AFL6810W-M-TL-30N36-B
10W	434	50°	AFL6810W-M-TL-30N50-B



W system	lm system	optics	code
12W	648	15°	AFL6812W-M-TL-30N15-B
12W	636	24°	AFL6812W-M-TL-30N24-B
12W	624	36°	AFL6812W-M-TL-30N36-B
12W	583	50°	AFL6812W-M-TL-30N50-B

Φ78 Engine Semi-recessed Adjustable Round Downlight



cutout:78mm



Adjustable Optic

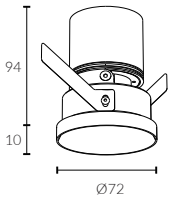

bezel | baffle



- IP Rating:** IP20 and IP44 options
- Optics:** 15°/24°/36°/50°
- UGR:** < 10
- CRI:** 98Ra
- Lifetime:** > 50,000 hrs (L70 B10)
- CCT:** 2700K/3000K/3500K/4000K/5000K/2000K-3000K/1800K-4000K/2700K-6000K

- Typical Source Efficacy (lm/W):** 110
- Control:** On/off, Mains Dim, 0/1-10V, Dali, Zigbee, Casambi
- Binning:** 2 Step MacAdams
- Input:** AC220-240V 50/60Hz
- Output:** DC 36V 200mA 8W
DC 36V 250mA 10W
DC 36V 300mA 12W

- Ambient temp:** -20 °C to 45 °C
- Class:** II
- Optional accessories:** Honeycomb louvre, Solite Lense, Spread Lense, Colour Filter
- Ceiling Thickness:** 9mm-28mm
- Material:** Fine aluminium 6063A
- Fire resistance test:** 60 minutes

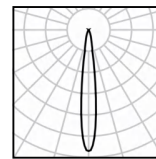

12W Ra98 3000K 15°

h(m)	E(lx)	D(m)
0.5	18360	0.13
1.0	4590	0.26
1.5	2040	0.39
2.0	1148	0.52
2.5	734	0.65
3.0	510	0.78

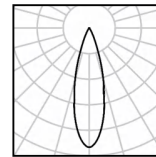

12W Ra98 3000K 24°

h(m)	E(lx)	D(m)
0.5	6420	0.22
1.0	1605	0.44
1.5	713	0.65
2.0	401	0.87
2.5	257	1.09
3.0	178	1.31

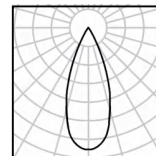

12W Ra98 3000K 36°

h(m)	E(lx)	D(m)
0.5	2791	0.31
1.0	698	0.62
1.5	310	0.93
2.0	174	1.25
2.5	112	1.56
3.0	78	1.87

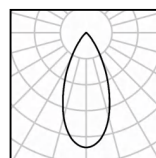

12W Ra98 3000K 50°

h(m)	E(lx)	D(m)
0.5	1324	0.52
1.0	331	1.03
1.5	147	1.55
2.0	83	2.06
2.5	53	2.58
3.0	37	3.10

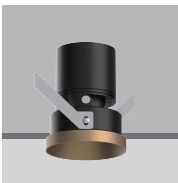

W system	lm system	optics	code
8W	450	15°	AFL7808W-M-30N15-B
8W	442	24°	AFL7808W-M-30N24-B
8W	397	36°	AFL7808W-M-30N36-B
8W	327	50°	AFL7808W-M-30N50-B



W system	lm system	optics	code
10W	580	15°	AFL7810W-M-30N15-B
10W	563	24°	AFL7810W-M-30N24-B
10W	519	36°	AFL7810W-M-30N36-B
10W	500	50°	AFL7810W-M-30N50-B

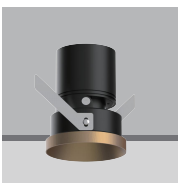

W system	lm system	optics	code
12W	689	15°	AFL7812W-M-30N15-B
12W	671	24°	AFL7812W-M-30N24-B
12W	618	36°	AFL7812W-M-30N36-B
12W	598	50°	AFL7812W-M-30N50-B

ACME SEMI

Φ78 Engine Semi-recessed Trimless Adjustable Round Downlight



view on website



cutout: 78mm



Adjustable Optic

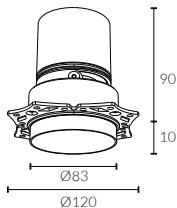

baffle



IP Rating:	IP20 and IP44 options
Optics:	15°/24°/36°/50°
UGR:	< 10
CRI:	98Ra
Lifetime:	> 50,000 hrs (L70 B10)
CCT:	2700K/3000K/3500K/4000K/5000K/ 2000K-3000K/1800K-4000K/2700K-6000K
Typical Source Efficacy (lm/W):	110
Control:	On/off, Mains Dim, 0/1-10V, Dali, Zigbee, Casambi
Binning:	2 Step MacAdams
Input:	AC 220-240V 50/60Hz
Output:	DC 36V 200mA 8W DC 36V 250mA 10W DC 36V 300mA 12W
Ambient temp:	-20 °C to 45 °C
Class:	II
Optional accessories:	Honeycomb louvre, Solite Lens, Spread Lens, Colour Filter
Material:	Fine aluminium 6063A
Fire resistance test:	60 minutes

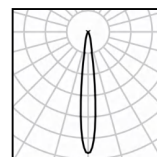

12W Ra98 3000K 15°

h(m)	E(lx)	D(m)
0.5	18360	0.13
1.0	4590	0.26
1.5	2040	0.39
2.0	1148	0.52
2.5	734	0.65
3.0	510	0.78

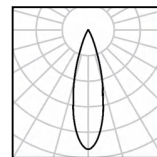

12W Ra98 3000K 24°

h(m)	E(lx)	D(m)
0.5	6420	0.22
1.0	1605	0.44
1.5	713	0.65
2.0	401	0.87
2.5	257	1.09
3.0	178	1.31

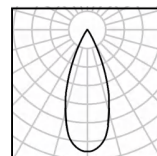

12W Ra98 3000K 36°

h(m)	E(lx)	D(m)
0.5	2791	0.31
1.0	698	0.62
1.5	310	0.93
2.0	174	1.25
2.5	112	1.56
3.0	78	1.87

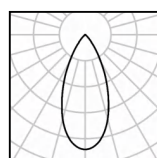

12W Ra98 3000K 50°

h(m)	E(lx)	D(m)
0.5	1324	0.52
1.0	331	1.03
1.5	147	1.55
2.0	83	2.06
2.5	53	2.58
3.0	37	3.10



W system	lm system	optics	code
8W	450	15°	AFL7808W-M-TL-30N15
8W	442	24°	AFL7808W-M-TL-30N24
8W	397	36°	AFL7808W-M-TL-30N36
8W	327	50°	AFL7808W-M-TL-30N50



W system	lm system	optics	code
10W	580	15°	AFL7810W-M-TL-30N15
10W	563	24°	AFL7810W-M-TL-30N24
10W	519	36°	AFL7810W-M-TL-30N36
10W	500	50°	AFL7810W-M-TL-30N50



W system	lm system	optics	code
12W	689	15°	AFL7812W-M-TL-30N15
12W	671	24°	AFL7812W-M-TL-30N24
12W	618	36°	AFL7812W-M-TL-30N36
12W	598	50°	AFL7812W-M-TL-30N50

ACME SQUARE

Φ68 Engine Adjustable Square Downlight



view on website



cutout :80*80mm



Adjustable Optic

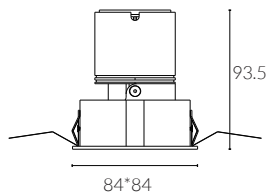

bezel | baffle



White Painted 9016



Black Painted 9005

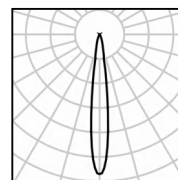

h(m)	E(lx)	D(m)
0.5	10897	0.17
1.0	2724	0.33
1.5	1211	0.50
2.0	681	0.66
2.5	436	0.83
3.0	303	0.99

12W Ra98 3000K 15°

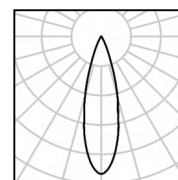

h(m)	E(lx)	D(m)
0.5	8621	0.20
1.0	2155	0.41
1.5	958	0.61
2.0	539	0.81
2.5	345	1.02
3.0	239	1.22

12W Ra98 3000K 24°

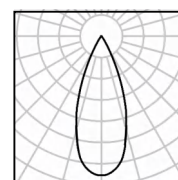

h(m)	E(lx)	D(m)
0.5	4792	0.28
1.0	1198	0.55
1.5	532	0.83
2.0	300	1.10
2.5	192	1.38
3.0	133	1.65

12W Ra98 3000K 36°

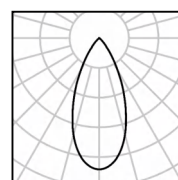

h(m)	E(lx)	D(m)
0.5	1608	0.47
1.0	402	0.93
1.5	179	1.40
2.0	100	1.87
2.5	64	2.33
3.0	45	2.80

12W Ra98 3000K 50°

IP Rating:	IP20 and IP44 options
Optics:	15°/24°/36°/50°
UGR:	<10
CRI:	98Ra
Lifetime:	>50,000 hrs (L70 B10)
CCT:	2700K/3000K/3500K/4000K/5000K/ 2000K-3000K/1800K-4000K/2700K-6000K

Typical Source Efficacy (lm/W): 110

Control:	On/off, Mains Dim, 0/1-10V, Dali, Zigbee, Casambi
Binning	2 Step MacAdams
Input:	AC220-240V 50/60Hz
Output:	DC 36V 200mA 8W DC 36V 250mA 10W DC 36V 300mA 12W

Ambient temp: -20 °C to 45 °C

Class: II

Optional accessories: Honeycomb louvre, Solite Lense, Spread Lense, Colour Filter

Ceiling Thickness: 9mm-28mm

Material: Fine aluminium 6063A

Fire resistance test: 60 minutes



W system	lm system	optics	code
8W	487	15°	AFL6808W-Q-30N15-B
8W	503	24°	AFL6808W-Q-30N24-B
8W	492	36°	AFL6808W-Q-30N36-B
8W	427	50°	AFL6808W-Q-30N50-B



W system	lm system	optics	code
10W	553	15°	AFL6810W-Q-30N15-B
10W	575	24°	AFL6810W-Q-30N24-B
10W	565	36°	AFL6810W-Q-30N36-B
10W	485	50°	AFL6810W-Q-30N50-B



W system	lm system	optics	code
12W	717	15°	AFL6812W-Q-30N15-B
12W	760	24°	AFL6812W-Q-30N24-B
12W	750	36°	AFL6812W-Q-30N36-B
12W	640	50°	AFL6812W-Q-30N50-B

ACME SQUARE

Φ68 Engine Adjustable Twin Square Downlight



view on website



cutout: 156*80mm



Adjustable Optic



bezel | baffle



White Painted 9016



Black Painted 9005

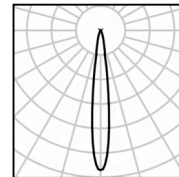
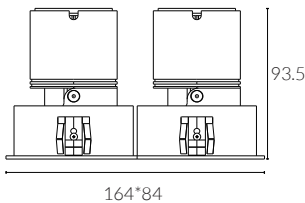

12W Ra98 3000K 15°

h(m)	E(lx)	D(m)
0.5	10897	0.17
1.0	2724	0.33
1.5	1211	0.50
2.0	681	0.66
2.5	436	0.83
3.0	303	0.99

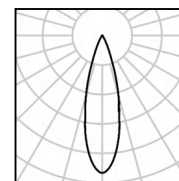

12W Ra98 3000K 24°

h(m)	E(lx)	D(m)
0.5	8621	0.20
1.0	2155	0.41
1.5	958	0.61
2.0	539	0.81
2.5	345	1.02
3.0	239	1.22

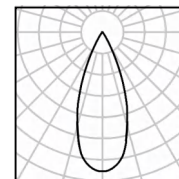

12W Ra98 3000K 36°

h(m)	E(lx)	D(m)
0.5	4792	0.28
1.0	1198	0.55
1.5	532	0.83
2.0	300	1.10
2.5	192	1.38
3.0	133	1.65

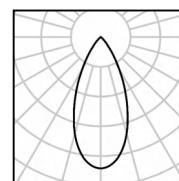

12W Ra98 3000K 50°

h(m)	E(lx)	D(m)
0.5	1608	0.47
1.0	402	0.93
1.5	179	1.40
2.0	100	1.87
2.5	64	2.33
3.0	45	2.80

IP Rating:	IP20 and IP44 options
Optics:	15°/24°/36°/50°
UGR:	< 10
CRI:	98Ra
Lifetime:	>50,000 hrs (L70 B10)
CCT:	2700K/3000K/3500K/4000K/5000K/ 2000K-3000K/1800K-4000K/2700K-6000K

Typical Source

Efficacy (lm/W):	110
Control:	On/off, Mains Dim, 0/1-10V, Dali, Zigbee, Casambi
Binning	2 Step MacAdams
Input:	AC220-240V 50/60Hz
Output:	DC 36V 200mA 8W x 2 DC 36V 250mA 10W x 2 DC 36V 300mA 12W x 2

Ambient temp:	-20 °C to 45 °C
Class:	II
Optional accessories:	Honeycomb louvre, Solite Lense, Spread Lense, Colour Filter

Ceiling Thickness: 9mm-28mm

Material: Fine aluminium 6063A



DuraGreen project:
London Luxury Home



W system	lm system	optics	code
8W x 2	487 x 2	15°	AFL6808WX2-Q-30N15-B
8W x 2	503 x 2	24°	AFL6808WX2-Q-30N24-B
8W x 2	492 x 2	36°	AFL6808WX2-Q-30N36-B
8W x 2	427 x 2	50°	AFL6808WX2-Q-30N50-B



W system	lm system	optics	code
10W x 2	553 x 2	15°	AFL6810WX2-Q-30N15-B
10W x 2	575 x 2	24°	AFL6810WX2-Q-30N24-B
10W x 2	565 x 2	36°	AFL6810WX2-Q-30N36-B
10W x 2	485 x 2	50°	AFL6810WX2-Q-30N50-B



W system	lm system	optics	code
12W x 2	717 x 2	15°	AFL6812WX2-Q-30N15-B
12W x 2	760 x 2	24°	AFL6812WX2-Q-30N24-B
12W x 2	750 x 2	36°	AFL6812WX2-Q-30N36-B
12W x 2	640 x 2	50°	AFL6812WX2-Q-30N50-B

ACME SQUARE

Φ68 Engine

Trimless Adjustable Square Downlight



view on website



cutout :80*80mm



Adjustable Optic



baffle

○ White Painted 9016

● Black Painted 9005

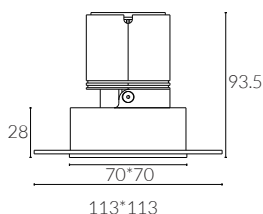

IP Rating:	IP20 and IP44 options
Optics:	15°/24°/36°/50°
UGR:	< 10
CRI:	98Ra
Lifetime:	>50,000 hrs (L70 B10)
CCT:	2700K/3000K/3500K/4000K/5000K/ 2000K-3000K/1800K-4000K/2700K-6000K

Typical Source	
Efficacy (lm/W):	110
Control:	On/off, Mains Dim, 0/1-10V, Dali, Zigbee, Casambi
Binning	2 Step MacAdams
Input:	AC220-240V 50/60Hz
Output:	DC 36V 200mA 8W DC 36V 250mA 10W DC 36V 300mA 12W

Ambient temp:	-20 °C to 45 °C
Class:	II
Optional accessories:	Honeycomb louvre, Solite Lense, Spread Lense, Colour Filter
Material:	Fine aluminium 6063A
Fire resistance test:	60 minutes

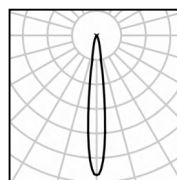

h(m)	E(lx)	D(m)
0.5	10897	0.17
1.0	2724	0.33
1.5	1211	0.50
2.0	681	0.66
2.5	436	0.83
3.0	303	0.99

12W Ra98 3000K 15°

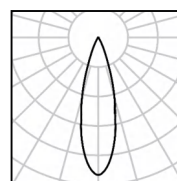

h(m)	E(lx)	D(m)
0.5	8621	0.20
1.0	2155	0.41
1.5	958	0.61
2.0	539	0.81
2.5	345	1.02
3.0	239	1.22

12W Ra98 3000K 24°

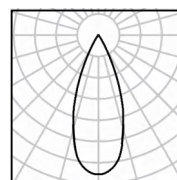

h(m)	E(lx)	D(m)
0.5	4792	0.28
1.0	1198	0.55
1.5	532	0.83
2.0	300	1.10
2.5	192	1.38
3.0	133	1.65

12W Ra98 3000K 36°

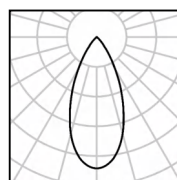

h(m)	E(lx)	D(m)
0.5	1608	0.47
1.0	402	0.93
1.5	179	1.40
2.0	100	1.87
2.5	64	2.33
3.0	45	2.80

12W Ra98 3000K 50°



W system	lm system	optics	code
8W	487	15°	AFL6808W-Q-TL-30N15-B
8W	503	24°	AFL6808W-Q-TL-30N24-B
8W	492	36°	AFL6808W-Q-TL-30N36-B
8W	427	50°	AFL6808W-Q-TL-30N50-B



W system	lm system	optics	code
10W	553	15°	AFL6810W-Q-TL-30N15-B
10W	575	24°	AFL6810W-Q-TL-30N24-B
10W	565	36°	AFL6810W-Q-TL-30N36-B
10W	485	50°	AFL6810W-Q-TL-30N50-B



W system	lm system	optics	code
12W	717	15°	AFL6812W-Q-TL-30N15-B
12W	760	24°	AFL6812W-Q-TL-30N24-B
12W	750	36°	AFL6812W-Q-TL-30N36-B
12W	640	50°	AFL6812W-Q-TL-30N50-B

ACME SQUARE

Φ68 Engine Trimless Adjustable Twin Square Downlight



view on website



cutout :156*80mm



Adjustable Optic

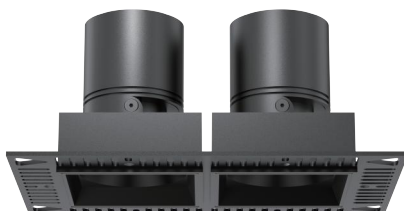

baffle



White Painted 9016



Black Painted 9005

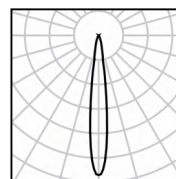
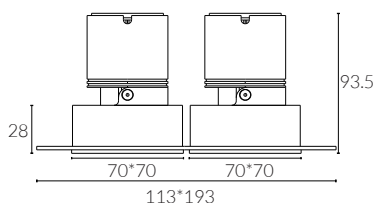

12W Ra98 3000K 15°

h(m)	E(lx)	D(m)
0.5	10897	0.17
1.0	2724	0.33
1.5	1211	0.50
2.0	681	0.66
2.5	436	0.83
3.0	303	0.99

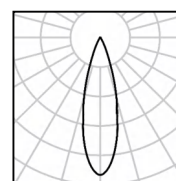

12W Ra98 3000K 24°

h(m)	E(lx)	D(m)
0.5	8621	0.20
1.0	2155	0.41
1.5	958	0.61
2.0	539	0.81
2.5	345	1.02
3.0	239	1.22

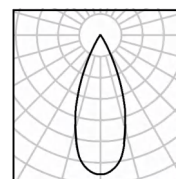

12W Ra98 3000K 36°

h(m)	E(lx)	D(m)
0.5	4792	0.28
1.0	1198	0.55
1.5	532	0.83
2.0	300	1.10
2.5	192	1.38
3.0	133	1.65

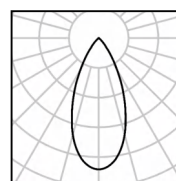

12W Ra98 3000K 50°

h(m)	E(lx)	D(m)
0.5	1608	0.47
1.0	402	0.93
1.5	179	1.40
2.0	100	1.87
2.5	64	2.33
3.0	45	2.80

- IP Rating:** IP20 and IP44 options
- Optics:** 15°/24°/36°/50°
- UGR:** < 10
- CRI:** 98Ra
- Lifetime:** >50,000 hrs (L70 B10)
- CCT:** 2700K/3000K/3500K/4000K/5000K/
2000K-3000K/1800K-4000K/2700K-6000K

Typical Source

- Efficacy (lm/W):** 110
- Control:** On/off, Mains Dim, 0/1-10V, Dali, Zigbee, Casambi
- Binning** 2 Step MacAdams
- Input:** AC220-240V 50/60Hz
- Output:** DC 36V 200mA 8W x 2
DC 36V 250mA 10W x 2
DC 36V 300mA 12W x 2

- Ambient temp:** -20 °C to 45 °C
- Class:** II
- Optional accessories:** Honeycomb louvre, Solite Lense, Spread Lense, Colour Filter
- Material:** Fine aluminium 6063A



W system	Im system	optics	code
8W x 2	487 x 2	15°	AFL6808WX2-Q-TL-30N15-B
8W x 2	503 x 2	24°	AFL6808WX2-Q-TL-30N24-B
8W x 2	492 x 2	36°	AFL6808WX2-Q-TL-30N36-B
8W x 2	427 x 2	50°	AFL6808WX2-Q-TL-30N50-B



W system	Im system	optics	code
10W x 2	553 x 2	15°	AFL6810WX2-Q-TL-30N15-B
10W x 2	575 x 2	24°	AFL6810WX2-Q-TL-30N24-B
10W x 2	565 x 2	36°	AFL6810WX2-Q-TL-30N36-B
10W x 2	485 x 2	50°	AFL6810WX2-Q-TL-30N50-B



W system	Im system	optics	code
12W x 2	717 x 2	15°	AFL6812WX2-Q-TL-30N15-B
12W x 2	760 x 2	24°	AFL6812WX2-Q-TL-30N24-B
12W x 2	750 x 2	36°	AFL6812WX2-Q-TL-30N36-B
12W x 2	640 x 2	50°	AFL6812WX2-Q-TL-30N50-B

ACME WALL-WASHER

Φ68 Engine

Fixed Round Wall Wash Downlight



view on website



cutout: 68mm



WallWash Optic

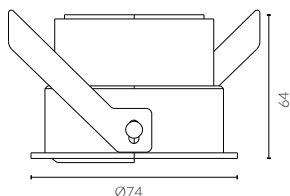

bezel | baffle



White Painted 9016



Black Painted 9005

- IP Rating:** IP20 and IP44 options
- Optics:** Asymmetrical Wallwash
- UGR:** < 10
- CRI:** 98Ra
- Lifetime:** > 50,000 hrs (L70 B10)
- CCT:** 2700K/3000K/3500K/4000K/5000K/
2000K-3000K/1800K-4000K/2700K-6000K

- Typical Source Efficacy (lm/W):** 110
- Control:** On/off, Mains Dim, 0/1-10V, Dali, Zigbee, Casambi
- Binning:** 2 Step MacAdams
- Input:** AC220-240V 50/60Hz
- Output:** DC 36V 350mA 15W
- Ambient temp:** -20 °C to 45 °C
- Class:** II
- Ceiling Thickness:** 9mm-28mm
- Material:** Fine aluminium 6063A
- Fire resistance test:** 60 minutes

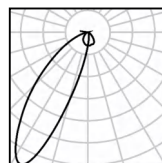

15W Ra98 3000K
Asymmetrical

h(m)	E(lx)	D(m)
0.5	50	0.82
1.0	12	1.64
1.5	6	2.46
2.0	3	3.27
2.5	2	4.09
3.0	1	4.91

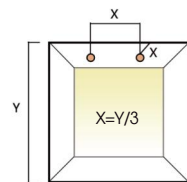

X = distance to wall
= ceiling height ÷ 3



W system	lm system	optics	code
15W	448	Asymmetrical Wallwash	MFL6815W-30NWS

ACME WALL-WASHER

Φ68 Engine

Trimless Wall Wash Downlight



view on website



cutout: 68mm



Wall Wash Optic

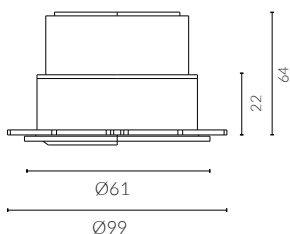

baffle



White Painted 9016



Black Painted 9005

- IP Rating:** IP20 and IP44 options
- Optics:** Asymmetrical Wallwash
- UGR:** < 10
- CRI:** 98Ra
- Lifetime:** >50,000 hrs (L70 B10)
- CCT:** 2700K/3000K/3500K/4000K/5000K/
2000K-3000K/1800K-4000K/2700K-6000K

- Typical Source Efficacy (lm/W):** 110
- Control:** On/off, Mains Dim, 0/1-10V, Dali, Zigbee, Casambi
- Binning:** 2 Step MacAdams
- Input:** AC220-240V 50/60Hz
- Output:** DC 36V 350mA 15W
- Ambient temp:** -20 °C to 45 °C
- Class:** II
- Material:** Fine aluminium 6063A
- Fire resistance test:** 60 minutes

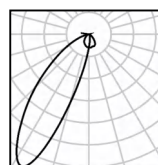

15W Ra98 3000K
Asymmetrical

h(m)	E lx	D(m)
0.5	50	0.82
1.0	12	1.64
1.5	6	2.46
2.0	3	3.27
2.5	2	4.09
3.0	1	4.91

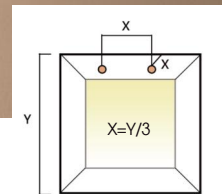

X = distance to wall
= ceiling height ÷ 3



W system	lm system	optics	code
15W	448	Asymmetrical Wallwash	MFL6815W-TL-30NWS

ACME WALL-WASHER

DISCONTINUED

Φ68 Engine

Fixed Square Wall Wash Downlight



cutout : 68*68mm



Wall Wash Optic

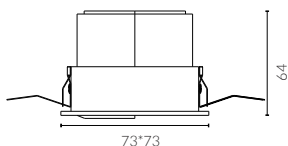

bezel | baffle

○ White Painted 9016

● Black Painted 9005

IP Rating: IP20 and IP44 options
Optics: Asymmetrical Wallwash
UGR: < 10
CRI: 98Ra
Lifetime: > 50,000 hrs (L70 B10)
CCT: 2700K/3000K/3500K/4000K/5000K/
 2000K-3000K/1800K-4000K/2700K-6000K

Typical Source Efficacy (lm/W): 110
Control: On/off, Mains Dim, 0/1-10V, Dali, Zigbee, Casambi
Binning: 2 Step MacAdams
Input: AC220-240V 50/60Hz
Output: DC 36V 350mA 15W
Ambient temp: -20 °C to 45 °C
Class: II
Ceiling Thickness: 9mm-28mm
Material: Fine aluminium 6063A
Fire resistance test: 60 minutes

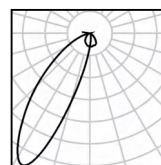

15W Ra98 3000K
Asymmetrical

h(m)	E lx	D(m)
0.5	50	0.82
1.0	12	1.64
1.5	6	2.46
2.0	3	3.27
2.5	2	4.09
3.0	1	4.91

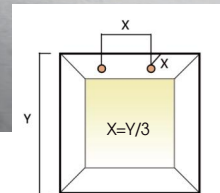

X = distance to wall
= ceiling height ÷ 3

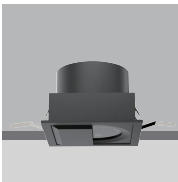

W system	lm system	optics	code
15W	448	Asymmetrical Wallwash	MFL6815W-Q-30NWS

ACME WALL-WASHER

DISCONTINUED

Φ68 Engine

Trimless Square Wall Wash Downlight

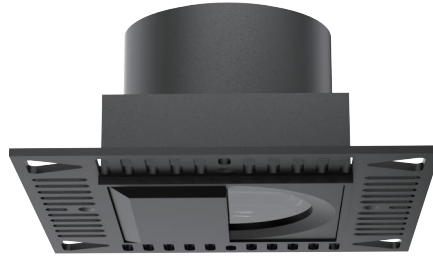

baffle

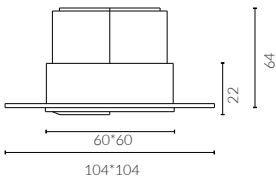
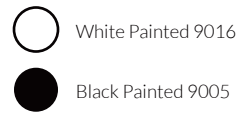

IP Rating:	IP20 and IP44 options
Optics:	Asymmetrical Wallwash
UGR:	< 10
CRI:	98Ra
Lifetime:	>50,000 hrs (L70 B10)
CCT:	2700K/3000K/3500K/4000K/5000K/ 2000K-3000K/1800K-4000K/2700K-6000K

Typical Source Efficacy (lm/W):	110
Control:	On/off, Mains Dim, 0/1-10V, Dali, Zigbee, Casambi
Binning	2 Step MacAdams
Input:	AC220-240V 50/60Hz
Output:	DC 36V 350mA 15W
Ambient temp:	-20 °C to 45 °C
Class:	II
Material:	Fine aluminium 6063A
Fire resistance test:	60 minutes

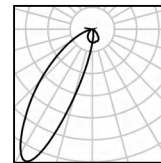

h(m)	E(lx)	D(m)
0.5	50	0.82
1.0	12	1.64
1.5	6	2.46
2.0	3	3.27
2.5	2	4.09
3.0	1	4.91

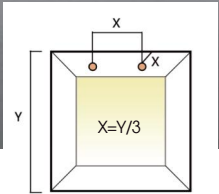
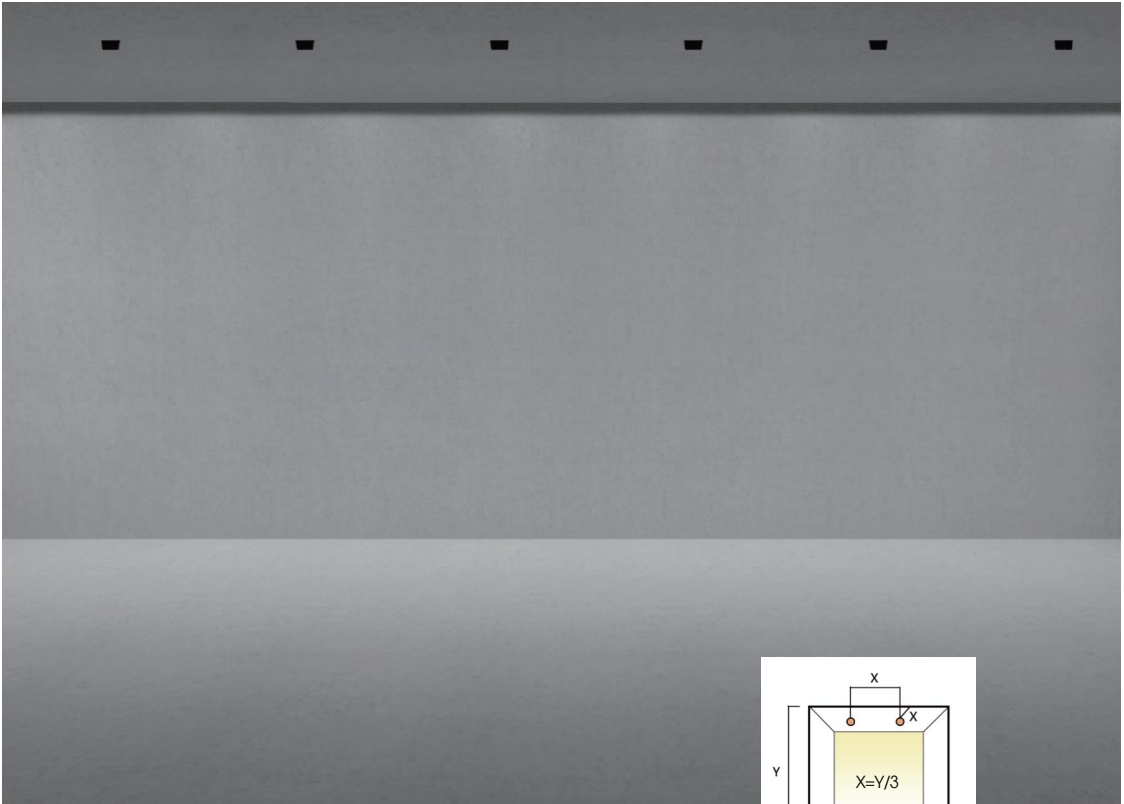

X = distance to wall
= ceiling height ÷ 3

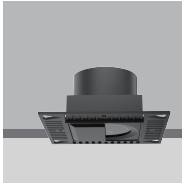

W system	lm system	optics	code
15W	448	Asymmetrical Wallwash	MFL6815W-Q-TL-30NWS



MOOD light fittings, stylishly designed with trendy colors and high-quality materials, radiate sophistication and elegance. They offer endless possibilities and exceptional versatility, easily adapting to any space.





Black Matt



White Matt



Silver Matt



Black Specular



Silver Specular



Gold Specular



Grey Specular

D for DuraGreen Design

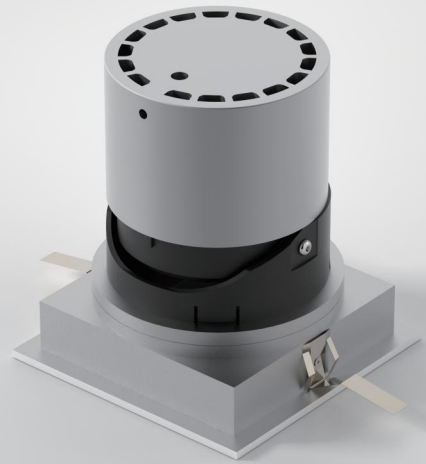

Specification Code

Type	Cut out	Power	Colour Temp	Driver	Beam Width	Bezel Colour	Baffle Colour	Options
MF	75	08W	30	N	24	W	B	C
MF/Fixed	22/22mm		27/2700K	M/Mains Dim	05/5°	W/White	B/Black Specular	C/Clear Lens
AF/Adjustable	33/33mm		30/3000K	D/DALI	10/10°	B/Black	S/Silver Specular	F/Frosted Lens
MFL/Lens type, Fixed	35/35mm 40/40mm		40/4000K WD/Warm Dim	0/0-10V N/Non Dim	13/13° 15/15°	L/Polished Chrome G/Polished Brass	W/White Matt BM/Black Matt	H/Honeycomb S/Spread Lense
AFL/Lens type, Adjustable	45/45mm 55/55mm		1840/1800K-4000K 2765/2700K-6500K	X/No Driver	20/20° 24/24°	J/Antique Bronze S/Satin Nickle		
MFW/Wall Wash	58/58mm				30/30°			
MFZ/Zoomable	75/75mm				36/36°			
MFP/Pinhole	80/80mm				50/50°			
MFQ/Fixed Square	100/100mm							

MOOD MINI

Φ22 Fixed Round



cutout:22mm



Fixed Optic



view on website

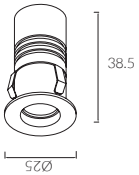

Accessories not included

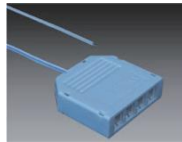

4-way connector

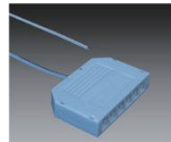

6-way connector

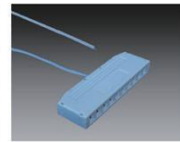

10-way connector

IP Rating:	IP20
Optics:	30°
UGR:	< 17
CRI:	92Ra
Lifetime:	>50,000 hrs (L70 B10)
CCT:	3000K
Typical Source Efficacy (lm/W):	103
Control:	On/off, Mains Dim, 0/1-10V, Dali, Zigbee, Casambi
Binning:	2 Step MacAdams
Input:	AC220-240V 50/60Hz
Output:	DC 3V 300mA 1.3W
Ambient temp:	-20 °C to 45 °C
Class:	II

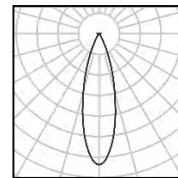

1.3W Ra92 3000K 30°

h(m)	E(lx)	D(m)
0.5	260	0.29
1.0	65	0.59
1.5	29	0.88
2.0	16	1.18
2.5	10	1.47
3.0	7	1.77



W system	lm system	optics	code
1.3W	68	30°	MDL221.3W-30NL30-B

MOOD MINI

Φ33 Fixed Round



cutout:33mm



Fixed Optic

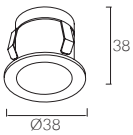

view on website

True non-intrusive-in lighting solutions to integrate lighting with architecture

IP Rating:	IP20
Optics:	13°/20°/30°
UGR:	<17
CRI:	92Ra
Lifetime:	>50,000 hrs (L70 B10)
CCT:	2700K/3000K
Typical Source Efficacy (lm/W):	103
Control:	On/off, Mains Dim, 0/1-10V, Dali, Zigbee, Casambi
Binning:	2 Step MacAdams
Input:	AC220-240V 50/60Hz
Output:	DC 3V 300mA 1.3W DC 3V 650mA 3W
Ambient temp:	-20 C to 45 C
Class :	II

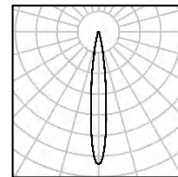

3W Ra92 3000K 13°

h(m)	E(lx)	D(m)
0.5	4168	0.11
1.0	1042	0.23
1.5	463	0.34
2.0	261	0.46
2.5	167	0.57
3.0	116	0.65

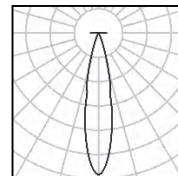

3W Ra92 3000K 20°

h(m)	E(lx)	D(m)
0.5	1872	0.18
1.0	468	0.36
1.5	208	0.55
2.0	117	0.73
2.5	75	0.91
3.0	52	1.09

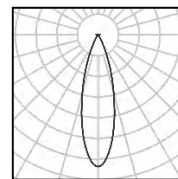

3W Ra92 3000K 30°

h(m)	E(lx)	D(m)
0.5	855	0.25
1.0	214	0.50
1.5	95	0.75
2.0	53	1.00
2.5	34	1.26
3.0	24	1.51



DuraGreen project:
DuraGreen Showroom



W system	lm system	optics	code
1.3W	85	13°	MFL331.3W-30NL13-W
1.3W	98	20°	MFL331.3W-30NL20-W
1.3W	91	30°	MFL331.3W-30NL30-W



W system	lm system	optics	code
3W	165	13°	MFL3303W-30NL13-W
3W	167	20°	MFL3303W-30NL20-W
3W	147	30°	MFL3303W-30NL30-W

MOOD MINI

Φ40 Fixed Round

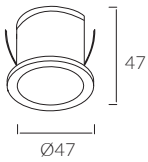

view on website

True non-intrusive-in lighting solutions to integrate lighting with architecture

IP Rating:	IP20
Optics:	13°/20°/30°
UGR:	<17
CRI:	92Ra
Lifetime:	>50,000 hrs (L70 B10)
CCT:	2700K/3000K
Typical Source Efficacy (lm/W):	103
Control:	On/off, Mains Dim, 0/1-10V, Dali, Zigbee, Casambi
Binning:	2 Step MacAdams
Input:	AC220-240V 50/60Hz
Output:	DC 3V 300mA 1.3W DC 3V 650mA 3W
Ambient temp:	-20 C to 45 C
Class :	II

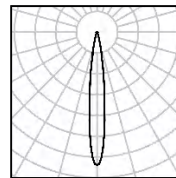

3W Ra92 3000K 13°

h(m)	E(lx)	D(m)
0.5	4168	0.11
1.0	1042	0.23
1.5	463	0.34
2.0	261	0.46
2.5	167	0.57
3.0	116	0.65

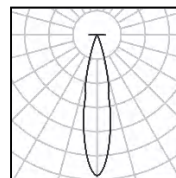

3W Ra92 3000K 20°

h(m)	E(lx)	D(m)
0.5	1872	0.18
1.0	468	0.36
1.5	208	0.55
2.0	117	0.73
2.5	75	0.91
3.0	52	1.09

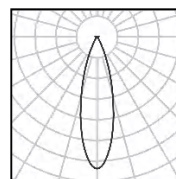

3W Ra92 3000K 30°

h(m)	E(lx)	D(m)
0.5	855	0.25
1.0	214	0.50
1.5	95	0.75
2.0	53	1.00
2.5	34	1.26
3.0	24	1.51



DuraGreen project:
Yue Kai Entertainment Office

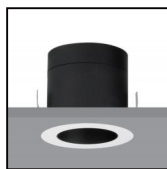

W system	lm system	optics	code
1.3W	85	13°	MFL401.3W-30NL13-W
1.3W	98	20°	MFL401.3W-30NL20-W
1.3W	91	30°	MFL401.3W-30NL30-W

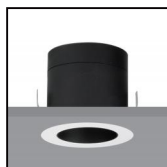

W system	lm system	optics	code
3W	165	13°	MFL4003W-30NL13-W
3W	167	20°	MFL4003W-30NL20-W
3W	147	30°	MFL4003W-30NL30-W

MOOD MINI

Φ40 Adjustable Round



view on website



DARK LIGHT VERSION

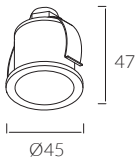

True non-intrusive-in lighting solutions to
integrate lighting with architecture

- IP Rating:** IP20
- Optics:** 13°/20°/30°
- UGR:** <17
- CRI:** 92Ra
- Lifetime:** >50,000 hrs (L70 B10)
- CCT:** 2700K/3000K
- Typical Source Efficacy (lm/W):** 103
- Control:** On/off, Mains Dim, 0/1-10V, Dali, Zigbee, Casambi
- Binning:** 2 Step MacAdams
- Input:** AC220-240V 50/60Hz
- Output:** DC 3V 300mA 1.3W
DC 3V 650mA 3W
- Ambient temp:** -20 C to 45 C
- Class :** II

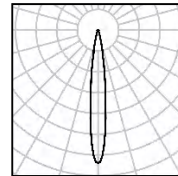

3W Ra92 3000K 13°

h(m)	E(lx)	D(m)
0.5	4168	0.11
1.0	1042	0.23
1.5	463	0.34
2.0	261	0.46
2.5	167	0.57
3.0	116	0.65

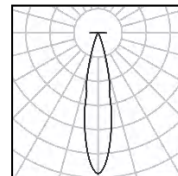

3W Ra92 3000K 20°

h(m)	E(lx)	D(m)
0.5	1872	0.18
1.0	468	0.36
1.5	208	0.55
2.0	117	0.73
2.5	75	0.91
3.0	52	1.09

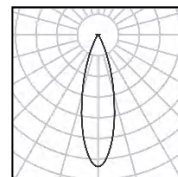

3W Ra92 3000K 30°

h(m)	E(lx)	D(m)
0.5	855	0.25
1.0	214	0.50
1.5	95	0.75
2.0	53	1.00
2.5	34	1.26
3.0	24	1.51



DuraGreen project:
DuraGreen Showroom



W system	lm system	optics	code
1.3W	85	13°	AFL401.3W-30NL13-W
1.3W	98	20°	AFL401.3W-30NL20-W
1.3W	91	30°	AFL401.3W-30NL30-W



W system	lm system	optics	code
3W	165	13°	AFL4003W-30NL13-W
3W	167	20°	AFL4003W-30NL20-W
3W	147	30°	AFL4003W-30NL30-W

MOOD STAR

Φ33 Fixed Round



cutout:33mm



Fixed Optic

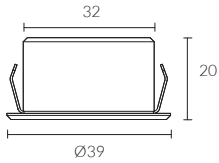

view on website

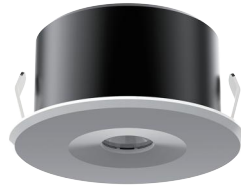

True non-intrusive-in lighting solutions to integrate lighting with architecture

IP Rating:	IP20
Optics:	15°/30°
UGR:	<17
CRI:	92Ra
Lifetime:	>50,000 hrs (L70 B10)
CCT:	2700K/3000K
Typical Source	
Efficacy (lm/W):	103
Control:	On/off, Mains Dim, 0/1-10V, Dali, Zigbee, Casambi
Binning:	2 Step MacAdams
Input:	AC 220-240V 50/60Hz
Output:	DC 3V 300mA 1.3W DC 3V 650mA 3W
Ambient temp:	-20 °C to 45 °C
Class :	II

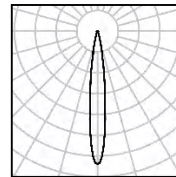

3W Ra92 3000K 15°

h(m)	E(lx)	D(m)
0.5	4168	0.11
1.0	1042	0.23
1.5	463	0.34
2.0	261	0.46
2.5	167	0.57
3.0	116	0.65

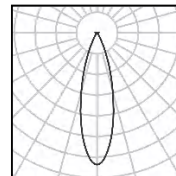

3W Ra92 3000K 30°

h(m)	E(lx)	D(m)
0.5	855	0.25
1.0	214	0.50
1.5	95	0.75
2.0	53	1.00
2.5	34	1.26
3.0	24	1.51



DuraGreen project:
Curio Hotel



W system	lm system	optics	code
1.3W	68	15°	MFL331.3W/S-30NL15-W
1.3W	85	30°	MFL331.3W/S-30NL30-W



W system	lm system	optics	code
3W	148	15°	MFL3303W/S-30NL15-W
3W	179	30°	MFL3303W/S-30NL30-W

MOOD STAR

Φ35 Adjustable Round



cutout:35mm



Adjustable Optic

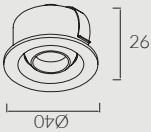

view on website

True non-intrusive-in lighting solutions to integrate lighting with architecture

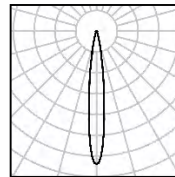

3W Ra92 3000K 15°

h(m)	E(lx)	D(m)
0.5	4168	0.11
1.0	1042	0.23
1.5	463	0.34
2.0	261	0.46
2.5	167	0.57
3.0	116	0.65

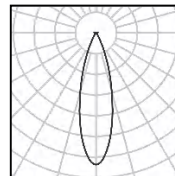

3W Ra92 3000K 30°

h(m)	E(lx)	D(m)
0.5	855	0.25
1.0	214	0.50
1.5	95	0.75
2.0	53	1.00
2.5	34	1.26
3.0	24	1.51

IP Rating:	IP20
Optics:	13°/20°/30°
UGR:	<17
CRI:	92Ra
Lifetime:	>50,000 hrs (L70 B10)
CCT:	2700K/3000K
Typical Source Efficacy (lm/W):	103
Control:	On/off, Mains Dim, 0/1-10V, Dali, Zigbee, Casambi
Binning:	2 Step MacAdams
Input:	AC220-240V 50/60Hz
Output:	DC 3V 300mA 1.3W DC 3V 650mA 3W
Ambient temp:	-20 °C to 45 °C
Class:	II



W system	lm system	optics	code
1.3W	68	15°	AFL351.3W-30NL15-W
1.3W	85	30°	AFL351.3W-30NL30-W



W system	lm system	optics	code
3W	148	15°	AFL3503W-30NL15-W
3W	179	30°	AFL3503W-30NL30-W

MOOD DOWNLIGHT

Φ45
Fixed Round



view on website



cutout :45mm



Fixed Optic

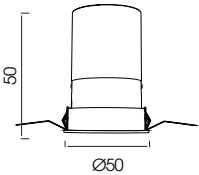

IP Rating: IP20 and IP44 options
Optics: 24°/36°/50°
UGR: < 10
CRI: 98Ra
Lifetime: >50,000 hrs (L70 B10)
CCT: 2700K/3000K/3500K/4000K/5000K/
 2000K-3000K/1800K-4000K/2700K-6000K

Typical Source
Efficacy (lm/W): 110
Control: On/off, Mains Dim, 0/1-10V, Dali, Zigbee, Casambi
Binning: 2 Step MacAdams
Input: AC220-240V 50/60Hz
Output: DC 36V 100mA 4W
 DC 36V 150mA 6W
Ambient temp: -20 °C to 45 °C
Class: II
Optional accessories: Honeycomb louvre, Solite Lense, Spread Lense,
 Colour Filter

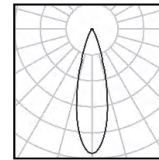

8W Ra98 3000K 24°

h(m)	E(lx)	D(m)
0.5	2868	0.24
1.0	717	0.49
1.5	319	0.73
2.0	179	0.98
2.5	115	1.22
3.0	80	1.46

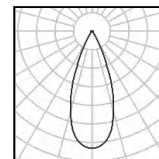

8W Ra98 3000K 36°

h(m)	E(lx)	D(m)
0.5	2108	0.36
1.0	527	0.72
1.5	234	1.08
2.0	132	1.44
2.5	84	1.80
3.0	59	2.16

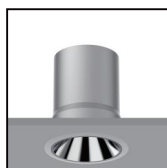

W system	lm system	optics	code
4W	303	24°	MFL4504W-30N24-W
4W	275	36°	MFL4504W-30N36-W
4W	263	50°	MFL4504W-30N50-W

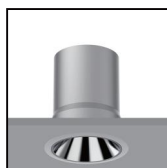

W system	lm system	optics	code
6W	397	24°	MFL4506W-30N24-W
6W	410	36°	MFL4506W-30N36-W
6W	407	50°	MFL4506W-30N50-W

MOOD DOWNLIGHT

Φ45 Adjustable Round



view on website



cutout :45mm



Adjustable Optic

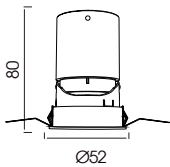

IP Rating:	IP20 and IP44 options
Optics:	15°/24°/36°/50°
UGR:	<10
CRI:	98Ra
Lifetime:	>50,000 hrs (L70 B10)
CCT:	2700K/3000K/3500K/4000K/5000K/ 2000K-3000K/1800K-4000K/2700K-6000K

Typical Source Efficacy (lm/W):	110
Control:	On/off, Mains Dim, 0/1-10V, Dali, Zigbee, Casambi
Binning:	2 Step MacAdams
Input:	AC220-240V 50/60Hz
Output:	DC 36V 100mA 4W DC 36V 150mA 6W DC 36V 200mA 8W

Ambient temp: -20 °C to 45 °C

Class: II

Optional accessories: Honeycomb louvre, Solite Lense, Spread Lense, Colour Filter

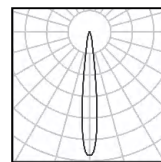

8W Ra98 3000K 15°

h(m)	E(lx)	D(m)
0.5	7550	0.11
1.0	1888	0.22
1.5	839	0.34
2.0	472	0.45
2.5	302	0.56
3.0	210	0.67

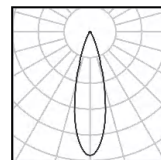

8W Ra98 3000K 24°

h(m)	E(lx)	D(m)
0.5	2868	0.24
1.0	717	0.49
1.5	319	0.73
2.0	179	0.98
2.5	115	1.22
3.0	80	1.46

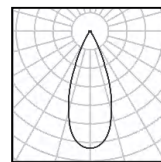

8W Ra98 3000K 36°

h(m)	E(lx)	D(m)
0.5	2108	0.36
1.0	527	0.72
1.5	234	1.08
2.0	132	1.44
2.5	84	1.80
3.0	59	2.16



DuraGreen project:
Black Stone Hillside Hotel



W system	lm system	optics	code
4W	188	15°	AFL4504W-30N15-W
4W	225	24°	AFL4504W-30N24-W
4W	282	36°	AFL4504W-30N36-W
4W	261	50°	AFL4504W-30N50-W



W system	lm system	optics	code
6W	270	15°	AFL4506W-30N15-W
6W	327	24°	AFL4506W-30N24-W
6W	410	36°	AFL4506W-30N36-W
6W	398	50°	AFL4506W-30N50-W



W system	lm system	optics	code
8W	328	15°	AFL4508W-30N15-W
8W	404	24°	AFL4508W-30N24-W
8W	499	36°	AFL4508W-30N36-W
8W	465	50°	AFL4508W-30N50-W

MOOD DOWNLIGHT

Φ55
Fixed Round



view on website



cutout :55mm



Fixed Optic

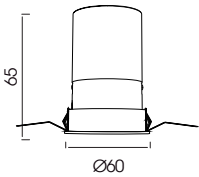

IP Rating: IP20 and IP44 options
Optics: 24°/36°/50°
UGR: < 10
CRI: 98Ra
Lifetime: >50,000 hrs (L70 B10)
CCT: 2700K/3000K/3500K/4000K/5000K/
 2000K-3000K/1800K-4000K/2700K-6000K

Typical Source
Efficacy (lm/W): 110
Control: On/off, Mains Dim, 0/1-10V, Dali, Zigbee, Casambi
Binning: 2 Step MacAdams
Input: AC220-240V 50/60Hz
Output: DC 36V 150mA 6W
 DC 36V 200mA 8W
 DC 36V 250mA 10W

Ambient temp: -20 °C to 45 °C

Class: II

Optional accessories: Honeycomb louvre, Solite Lense, Spread Lense,
 Colour Filter

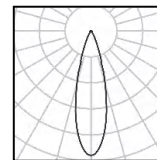

10W Ra98 3000K 24°

h(m)	E(lx)	D(m)
0.5	4847	0.21
1.0	1212	0.43
1.5	539	0.64
2.0	303	0.86
2.5	194	1.07
3.0	135	1.29

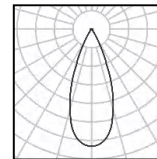

10W Ra98 3000K 36°

h(m)	E(lx)	D(m)
0.5	2553	0.32
1.0	638	0.65
1.5	284	0.97
2.0	160	1.29
2.5	102	1.61
3.0	71	1.94



DuraGreen project:
Edra Showroom

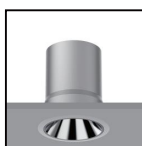

W system	lm system	optics	code
6W	405	24°	MFL5506W-30N24-W
6W	422	36°	MFL5506W-30N36-W
6W	407	50°	MFL5506W-30N50-W

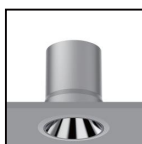

W system	lm system	optics	code
8W	480	24°	MFL5508W-30N24-W
8W	498	36°	MFL5508W-30N36-W
8W	473	50°	MFL5508W-30N50-W

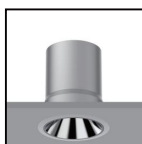

W system	lm system	optics	code
10W	550	24°	MFL5510W-30N24-W
10W	574	36°	MFL5510W-30N36-W
10W	566	50°	MFL5510W-30N50-W

MOOD DOWNLIGHT

Φ55
Adjustable Round



view on website



cutout :55mm



Adjustable Optic

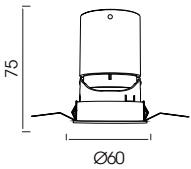

IP Rating:	IP20 and IP44 options
Optics:	10°/24°/36°/50°
UGR:	<10
CRI:	98Ra
Lifetime:	>50,000 hrs (L70 B10)
CCT:	2700K/3000K/3500K/4000K/5000K/ 2000K-3000K/1800K-4000K/2700K-6000K
Typical Source	
Efficacy (lm/W):	
Control:	110
Binning:	On/off, Mains Dim, 0/1-10V, Dali, Zigbee, Casambi
Input:	2 Step MacAdams
Output:	AC220-240V 50/60Hz DC 36V 150mA 6W DC 36V 200mA 8W DC 36V 250mA 10W
Ambient temp:	-20 °C to 45 °C
Class:	II
Optional accessories:	Honeycomb louvre, Solite Lense, Spread Lense, Colour Filter

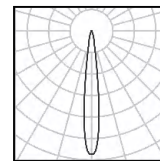

10W Ra98 3000K 10°

h(m)	E(lx)	D(m)
0.5	8431	0.11
1.0	2108	0.21
1.5	937	0.32
2.0	527	0.43
2.5	337	0.53
3.0	234	0.64

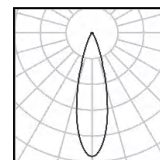

10W Ra98 3000K 24°

h(m)	E(lx)	D(m)
0.5	4847	0.21
1.0	1212	0.43
1.5	539	0.64
2.0	303	0.86
2.5	194	1.07
3.0	135	1.29

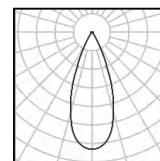

10W Ra98 3000K 36°

h(m)	E(lx)	D(m)
0.5	2553	0.32
1.0	638	0.65
1.5	284	0.97
2.0	160	1.29
2.5	102	1.61
3.0	71	1.94



DuraGreen project:
Hilton Hotel



W system	lm system	optics	code
6W	328	10°	AFL5506W-30N10-W
6W	407	24°	AFL5506W-30N24-W
6W	417	36°	AFL5506W-30N36-W
6W	411	50°	AFL5506W-30N50-W



W system	lm system	optics	code
8W	384	10°	AFL5508W-30N10-W
8W	501	24°	AFL5508W-30N24-W
8W	517	36°	AFL5508W-30N36-W
8W	513	50°	AFL5508W-30N50-W



W system	lm system	optics	code
10W	411	10°	AFL5510W-30N10-W
10W	554	24°	AFL5510W-30N24-W
10W	567	36°	AFL5510W-30N36-W
10W	559	50°	AFL5510W-30N50-W

MOOD DOWNLIGHT

Φ55 Trimless Adjustable Round



view on website



cutout :55mm



Adjustable Optic

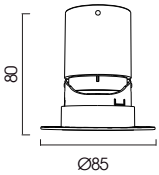

IP Rating:	IP20 and IP44 options
Optics:	10°/24°/36°/50°
UGR:	<10
CRI:	98Ra
Lifetime:	>50,000 hrs (L70 B10)
CCT:	2700K/3000K/3500K/4000K/5000K/ 2000K-3000K/1800K-4000K/2700K-6000K

Typical Source	
Efficacy (lm/W):	110
Control:	On/off, Mains Dim, 0/1-10V, Dali, Zigbee, Casambi
Binning:	2 Step MacAdams
Input:	AC220-240V 50/60Hz
Output:	DC 36V 150mA 6W DC 36V 200mA 8W DC 36V 250mA 10W
Ambient temp:	-20 °C to 45 °C
Class:	II
Optional accessories:	Honeycomb louvre, Solite Lense, Spread Lense, Colour Filter

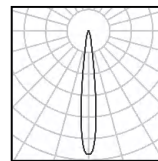

10W Ra98 3000K 10°

h(m)	E lx)	D(m)
0.5	8431	0.11
1.0	2108	0.21
1.5	937	0.32
2.0	527	0.43
2.5	337	0.53
3.0	234	0.64

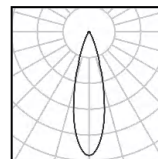

10W Ra98 3000K 24°

h(m)	E lx)	D(m)
0.5	4847	0.21
1.0	1212	0.43
1.5	539	0.64
2.0	303	0.86
2.5	194	1.07
3.0	135	1.29

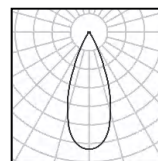

10W Ra98 3000K 36°

h(m)	E lx)	D(m)
0.5	2553	0.32
1.0	638	0.65
1.5	284	0.97
2.0	160	1.29
2.5	102	1.61
3.0	71	1.94



DuraGreen project:
Poliform Showroom



W system	lm system	optics	code
6W	328	10°	AFL5506W-TL-30N10
6W	407	24°	AFL5506W-TL-30N24
6W	417	36°	AFL5506W-TL-30N36
6W	411	50°	AFL5506W-TL-30N50



W system	lm system	optics	code
8W	384	10°	AFL5508W-TL-30N10
8W	501	24°	AFL5508W-TL-30N24
8W	517	36°	AFL5508W-TL-30N36
8W	513	50°	AFL5508W-TL-30N50



W system	lm system	optics	code
10W	411	10°	AFL5510W-TL-30N10
10W	554	24°	AFL5510W-TL-30N24
10W	567	36°	AFL5510W-TL-30N36
10W	559	50°	AFL5510W-TL-30N50

MOOD DOWNLIGHT

Φ55 Fixed Round Wall Wash



view on website



cutout :55mm



Wall Wash optic

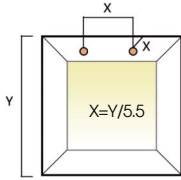

X = distance to wall
= ceiling height ÷ 5.5

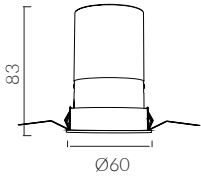
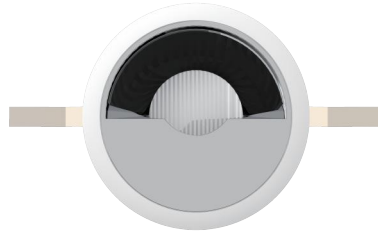
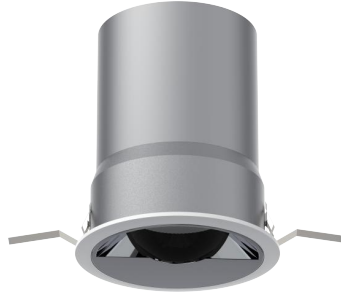

Recessed round wall-washer luminaire designed for creating a vertical downward beam of light

IP Rating:	IP20 and IP44 options
Optics:	Wall Wash
UGR:	< 17
CRI:	98Ra
Lifetime:	> 50,000 hrs (L70 B10)
CCT:	2700K/3000K/3500K/4000K/5000K/ 2000K-3000K/1800K-4000K/2700K-6000K

Typical Source	
Efficacy (lm/W):	110
Control:	On/off, Mains Dim, 0/1-10V, Dali, Zigbee, Casambi
Binning:	2 Step MacAdams
Input:	AC 220-240V 50/60Hz
Output:	DC 36V 150mA 6W DC 36V 200mA 8W DC 36V 250mA 10W
Ambient temp:	-20 °C to 45 °C
Class:	II

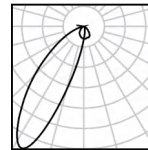

10W Ra98 3000K
Asymmetrical

h(m)	E(lx)	D(m)
0.5	1338	0.37
1.0	335	0.74
1.5	149	1.12
2.0	84	1.49
2.5	54	1.86
3.0	34	2.23



DuraGreen project:
Poliform Showroom



W system	lm system	optics	code
6W	326	Wall Wash	MFW5506W-30NWS-W



W system	lm system	optics	code
8W	383	Wall Wash	MFW5508W-30NWS-W



W system	lm system	optics	code
10W	442	Wall Wash	MFW5510W-30NWS-W

MOOD DOWNLIGHT

Φ58 Adjustable Round



view on website



cutout :58mm



Adjustable Optic

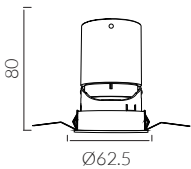

IP Rating:	IP20 and IP44 options
Optics:	10°/24°/36°/50°
UGR:	< 10
CRI:	98Ra
Lifetime:	>50,000 hrs (L70 B10)
CCT:	2700K/3000K/3500K/4000K/5000K/
Typical Source Efficacy (lm/W):	2000K-3000K/1800K-4000K/2700K-6000K
Control:	110
Binning:	On/off, Mains Dim, 0/1-10V, Dali, Zigbee, Casambi
Input:	2 Step MacAdams
Output:	AC220-240V 50/60Hz DC 36V 150mA 6W DC 36V 200mA 8W DC 36V 250mA 10W
Ambient temp:	-20 °C to 45 °C
Class:	II
Optional accessories:	Honeycomb louvre, Solite Lense, Spread Lense, Colour Filter

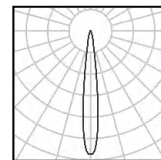

10W Ra98 3000K 10°

h(m)	E(lx)	D(m)
0.5	8431	0.11
1.0	2108	0.21
1.5	937	0.32
2.0	527	0.43
2.5	337	0.53
3.0	234	0.64

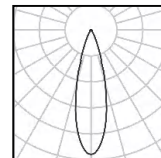

10W Ra98 3000K 24°

h(m)	E(lx)	D(m)
0.5	4847	0.21
1.0	1212	0.43
1.5	539	0.64
2.0	303	0.86
2.5	194	1.07
3.0	135	1.29

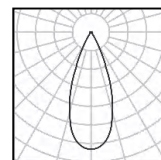

10W Ra98 3000K 36°

h(m)	E(lx)	D(m)
0.5	2553	0.32
1.0	638	0.65
1.5	284	0.97
2.0	160	1.29
2.5	102	1.61
3.0	71	1.94



DuraGreen project:
Golden Tulip Hotel



W system	lm system	optics	code
6W	328	10°	AFL6006W-30N10-W
6W	407	24°	AFL6006W-30N24-W
6W	417	36°	AFL6006W-30N36-W
6W	411	50°	AFL6006W-30N50-W



W system	lm system	optics	code
8W	384	10°	AFL6008W-30N10-W
8W	501	24°	AFL6008W-30N24-W
8W	517	36°	AFL6008W-30N36-W
8W	512	50°	AFL6008W-30N50-W



W system	lm system	optics	code
10W	411	10°	AFL6010W-30N10-W
10W	554	24°	AFL6010W-30N24-W
10W	567	36°	AFL6010W-30N36-W
10W	558	50°	AFL6010W-30N50-W

MOOD DOWNLIGHT

Φ75
Fixed Round



view on website

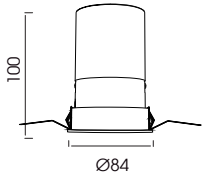

IP Rating: IP20 and IP44 options
Optics: 24°/36°/50°
UGR: <10
CRI: 98Ra
Lifetime: >50,000 hrs (L70 B10)
CCT: 2700K/3000K/3500K/4000K/5000K/
 2000K-3000K/1800K-4000K/2700K-6000K

Typical Source Efficacy (lm/W): 110
Control: On/off, Mains Dim, 0/1-10V, Dali, Zigbee, Casambi
Binning: 2 Step MacAdams
Input: AC220-240V 50/60Hz
Output: DC 36V 150mA 6W
 DC 36V 200mA 8W
 DC 36V 250mA 10W
 DC 36V 300mA 12W

Ambient temp: -20 °C to 45 °C

Class: II

Optional accessories: Honeycomb louvre, Solite Lense, Spread Lense, Colour Filter

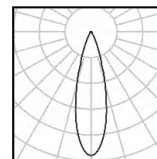

15W Ra98 3000K 24°

h(m)	E(lx)	D(m)
0.5	9636	0.20
1.0	2409	0.41
1.5	1071	0.61
2.0	602	0.81
2.5	385	1.02
3.0	268	1.22

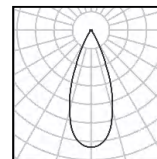

15W Ra98 3000K 36°

h(m)	E(lx)	D(m)
0.5	5780	0.30
1.0	1445	0.60
1.5	642	0.89
2.0	361	1.19
2.5	231	1.49
3.0	161	1.79

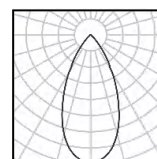

15W Ra98 3000K 50°

h(m)	E(lx)	D(m)
0.5	2268	0.46
1.0	567	0.92
1.5	252	1.37
2.0	142	1.83
2.5	91	2.29
3.0	63	2.75



DuraGreen project:
Gucci Showroom

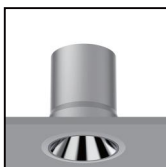

W system	lm system	optics	code
6W	522	24°	MF7506W-30N24-W
6W	542	36°	MF7506W-30N36-W
6W	538	50°	MF7506W-30N50-W

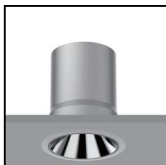

W system	lm system	optics	code
8W	648	24°	MF7508W-30N24-W
8W	671	36°	MF7508W-30N36-W
8W	655	50°	MF7508W-30N50-W

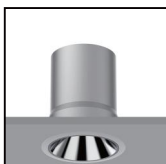

W system	lm system	optics	code
10W	817	24°	MF7510W-30N24-W
10W	845	36°	MF7510W-30N36-W
10W	829	50°	MF7510W-30N50-W

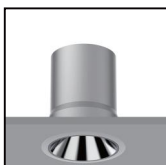

W system	lm system	optics	code
12W	939	24°	MF7512W-30N24-W
12W	968	36°	MF7512W-30N36-W
12W	954	50°	MF7512W-30N50-W

MOOD DOWNLIGHT

Φ75 Adjustable Round



view on website



cutout :75mm



Adjustable Optic

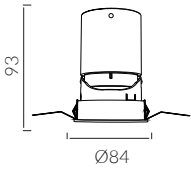

IP Rating: IP20 and IP44 options
Optics: 5°/10°/15°/24°/36°/50°
UGR: <10
CRI: 98Ra
Lifetime: >50,000 hrs (L70 B10)
CCT: 2700K/3000K/3500K/4000K/5000K/
 2000K-3000K/1800K-4000K/2700K-6000K

Typical Source
Efficacy (lm/W): 110
Control: On/off, Mains Dim, 0/1-10V, Dali, Zigbee, Casambi
Binning: 2 Step MacAdams
Input: AC220-240V 50/60Hz
Output: DC 3V 650mA 3W
 DC 36V 200mA 8W
 DC 36V 250mA 10W
 DC 36V 300mA 12W
 DC 36V 350mA 15W

Ambient temp: -20 °C to 45 °C
Class: II

Optional accessories: Honeycomb louvre, Solite Lense, Spread Lense,
 Colour Filter

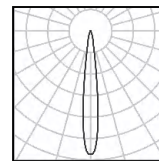

15W Ra98 3000K 15°

h(m)	E(lx)	D(m)
0.5	19856	0.12
1.0	4964	0.23
1.5	2206	0.35
2.0	1241	0.46
2.5	794	0.58
3.0	552	0.69

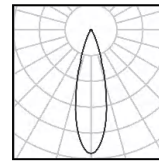

15W Ra98 3000K 24°

h(m)	E(lx)	D(m)
0.5	9636	0.20
1.0	2409	0.41
1.5	1071	0.61
2.0	602	0.81
2.5	385	1.02
3.0	268	1.22

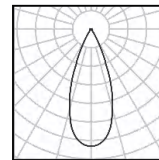

15W Ra98 3000K 36°

h(m)	E(lx)	D(m)
0.5	5780	0.30
1.0	1445	0.60
1.5	642	0.89
2.0	361	1.19
2.5	231	1.49
3.0	161	1.79

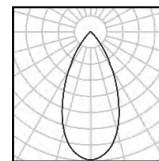

15W Ra98 3000K 50°

h(m)	E(lx)	D(m)
0.5	2268	0.46
1.0	567	0.92
1.5	252	1.37
2.0	142	1.83
2.5	91	2.29
3.0	63	2.75



W system	lm system	optics	code
3W	152	5°	AFL7503W-30N05-W



W system	lm system	optics	code
8W	415	10°	AFL7508W-30N10-W
8W	535	15°	AFL7508W-30N15-W
8W	598	24°	AFL7508W-30N24-W
8W	632	36°	AFL7508W-30N36-W
8W	573	50°	AFL7508W-30N50-W



W system	lm system	optics	code
10W	450	10°	AFL7510W-30N10-W
10W	590	15°	AFL7510W-30N15-W
10W	618	24°	AFL7510W-30N24-W
10W	699	36°	AFL7510W-30N36-W
10W	650	50°	AFL7510W-30N50-W



W system	lm system	optics	code
12W	531	10°	AFL7512W-30N10-W
12W	755	15°	AFL7512W-30N15-W
12W	860	24°	AFL7512W-30N24-W
12W	901	36°	AFL7512W-30N36-W
12W	835	50°	AFL7512W-30N50-W



W system	lm system	optics	code
15W	568	10°	AFL7515W-30N10-W
15W	858	15°	AFL7515W-30N15-W
15W	929	24°	AFL7515W-30N24-W
15W	1041	36°	AFL7515W-30N36-W
15W	952	50°	AFL7515W-30N50-W



DuraGreen project:
Bentley Home

MOOD DOWNLIGHT

Φ75 Fixed Round Wall Wash



view on website



cutout :75mm



Wall Wash optic

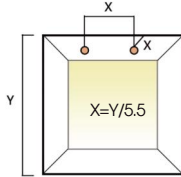

X = distance to wall
= ceiling height ÷ 5.5

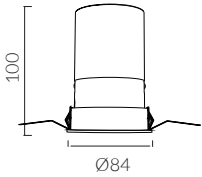
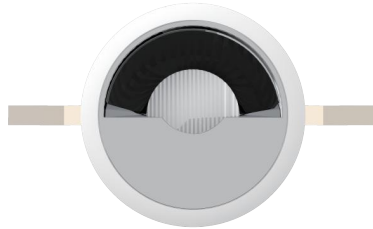
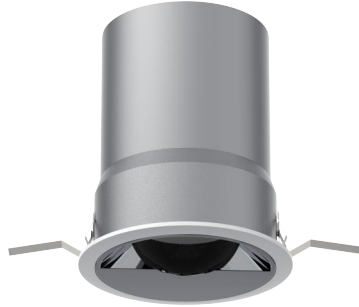

Recessed round wall-washer luminaire designed for creating a vertical downward beam of light

IP Rating:	IP20 and IP44 options
Optics:	Wall Wash
UGR:	< 17
CRI:	98Ra
Lifetime:	>50,000 hrs (L70 B10)
CCT:	2700K/3000K/3500K/4000K/5000K/ 2000K-3000K/1800K-4000K/2700K-6000K

Typical Source	
Efficacy (lm/W):	110
Control:	On/off, Mains Dim, 0/1-10V, Dali, Zigbee, Casambi
Binning:	2 Step MacAdams
Input:	AC220-240V 50/60Hz
Output:	DC 36V 200mA 8W DC 36V 250mA 10W DC 36V 300mA 12W
Ambient temp:	-20 C to 45 C
Class:	II

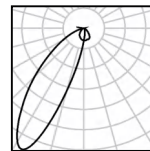

12W Ra98 3000K
Asymmetrical

h(m)	E lx	D(m)
0.5	1272	0.40
1.0	318	0.80
1.5	141	1.21
2.0	80	1.61
2.5	51	2.01
3.0	35	2.41



DuraGreen project:
Luxury Apartment



W system	lm system	optics	code
8W	406	Wall Wash	MFW7508W-30NWS-W



W system	lm system	optics	code
10W	516	Wall Wash	MFW7510W-30NWS-W



W system	lm system	optics	code
12W	590	Wall Wash	MFW7512W-30NWS-W

MOOD DOWNLIGHT

Φ75

Trimless Adjustable Round



view on website



cutout :75mm



Adjustable Optic

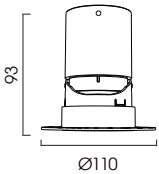

- IP Rating:** IP20 and IP44 options
- Optics:** 5°/10°/24°/36°/50°
- UGR:** <10
- CRI:** 98Ra
- Lifetime:** >50,000 hrs (L70 B10)
- CCT:** 2700K/3000K/3500K/4000K/5000K/
2000K-3000K/1800K-4000K/2700K-6000K
- Typical Source Efficacy (lm/W):** 110
- Control:** On/off, Mains Dim, 0/1-10V, Dali, Zigbee, Casambi
- Binning:** 2 Step MacAdams
- Input:** AC220-240V 50/60Hz
- Output:** DC 3V 650mA 3W
DC 36V 200mA 8W
DC 36V 250mA 10W
DC 36V 300mA 12W
DC 36V 350mA 15W
- Ambient temp:** -20 °C to 45 °C
- Class:** II
- Optional accessories:** Honeycomb louvre, Solite Lense, Spread Lense, Colour Filter

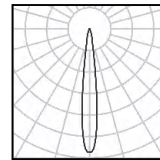

15W Ra98 3000K 15°

h(m)	E(lx)	D(m)
0.5	19856	0.12
1.0	4964	0.23
1.5	2206	0.35
2.0	1241	0.46
2.5	794	0.58
3.0	552	0.69

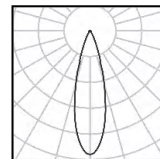

15W Ra98 3000K 24°

h(m)	E(lx)	D(m)
0.5	9636	0.20
1.0	2409	0.41
1.5	1071	0.61
2.0	602	0.81
2.5	385	1.02
3.0	268	1.22

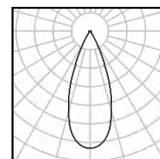

15W Ra98 3000K 36°

h(m)	E(lx)	D(m)
0.5	5780	0.30
1.0	1445	0.60
1.5	642	0.89
2.0	361	1.19
2.5	231	1.49
3.0	161	1.79

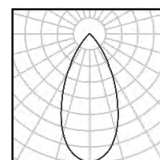

15W Ra98 3000K 50°

h(m)	E(lx)	D(m)
0.5	2268	0.46
1.0	567	0.92
1.5	252	1.37
2.0	142	1.83
2.5	91	2.29
3.0	63	2.75



DuraGreen project:
Poliform Showroom

W system	lm system	optics	code
3W	152	5°	AFL7503W-TL-30N05-W

W system	lm system	optics	code
8W	415	10°	AFL7508W-TL-30N10-W
8W	535	15°	AFL7508W-TL-30N15-W
8W	598	24°	AFL7508W-TL-30N24-W
8W	632	36°	AFL7508W-TL-30N36-W
8W	573	50°	AFL7508W-TL-30N50-W

W system	lm system	optics	code
10W	450	10°	AFL7510W-TL-30N10-W
10W	590	15°	AFL7510W-TL-30N15-W
10W	618	24°	AFL7510W-TL-30N24-W
10W	699	36°	AFL7510W-TL-30N36-W
10W	650	50°	AFL7510W-TL-30N50-W

W system	lm system	optics	code
12W	531	10°	AFL7512W-TL-30N10-W
12W	755	15°	AFL7512W-TL-30N15-W
12W	860	24°	AFL7512W-TL-30N24-W
12W	901	36°	AFL7512W-TL-30N36-W
12W	835	50°	AFL7512W-TL-30N50-W

W system	lm system	optics	code
15W	568	10°	AFL7515W-TL-30N10-W
15W	858	15°	AFL7515W-TL-30N15-W
15W	929	24°	AFL7515W-TL-30N24-W
15W	1041	36°	AFL7515W-TL-30N36-W
15W	952	50°	AFL7515W-TL-30N50-W

MOOD ZOOM

Φ75 Adjustable Round



cutout :75mm



Adjustable Optic

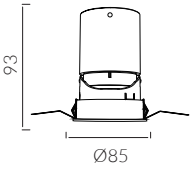

view on website

VARIABLE BEAM SPOT

IP Rating:	IP20 and IP44 options
Optics:	15°-50°
UGR:	<10
CRI:	98Ra
Lifetime:	>50,000 hrs (L70 B10)
CCT:	2700K/3000K/3500K/4000K/5000K/ 2000K-3000K/1800K-4000K/2700K-6000K

Typical Source	
Efficacy (lm/W):	110
Control:	On/off, Mains Dim, 0/1-10V, Dali, Zigbee, Casambi
Binning	2 Step MacAdams
Input:	AC220-240V 50/60Hz
Output:	DC 36V 250mA 10W
Ambient temp:	-20 C to 45 C
Class:	II
Optional accessories:	Honeycomb louvre, Solite Lens, Spread Lens, Colour Filter

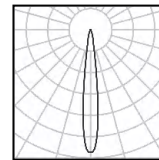

10W Ra98 3000K 15°

h(m)	E(lx)	D(m)
0.5	6134	0.14
1.0	1533	0.28
1.5	682	0.42
2.0	383	0.56
2.5	245	0.70
3.0	170	0.84

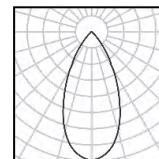

10W Ra98 3000K 50°

h(m)	E(lx)	D(m)
0.5	793	0.50
1.0	198	1.00
1.5	88	1.50
2.0	50	2.00
2.5	32	2.50
3.0	22	3.00



DuraGreen project:
2046 Black Pearl restaurant



W system	Im system	optics	code
10W	351-291	15°- 50°	AFZ7510W-30N1550-W

MOOD DOWNLIGHT

Φ 100
Fixed Round



view on website



cutout : 100mm



Fixed Optic

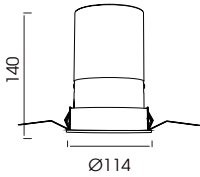

- IP Rating:** IP20 and IP44 options
- Optics:** 24°/36°/50°
- UGR:** < 10
- CRI:** 98Ra
- Lifetime:** >50,000 hrs (L70 B10)
- CCT:** 2700K/3000K/3500K/4000K/5000K
- Typical Source**
- Efficacy (lm/W):** 110
- Control:** On/off, Mains Dim, 0/1-10V, Dali, Zigbee, Casambi
- Binning:** 2 Step MacAdams
- Input:** AC 220-240V 50/60Hz
- Output:** DC 36V 500mA 20W
DC 36V 600mA 25W
DC 36V 750mA 30W
DC 36V 1000mA 40W
- Ambient temp:** -20 °C to 45 °C
- Class:** II
- Optional accessories:** Honeycomb louvre, Solite Lense, Spread Lense, Colour Filter

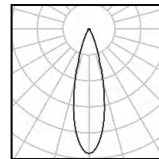

30W Ra98 3000K 24°

h(m)	E(lx)	D(m)
1.0	5888	0.39
2.0	1457	0.77
3.0	652	1.20
4.0	367	1.50
5.0	235	1.90
6.0	163	2.30

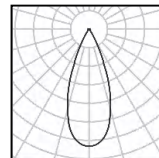

30W Ra98 3000K 36°

h(m)	E(lx)	D(m)
1.0	2991	0.54
2.0	748	1.10
3.0	332	1.60
4.0	187	2.20
5.0	120	2.70
6.0	83	3.20

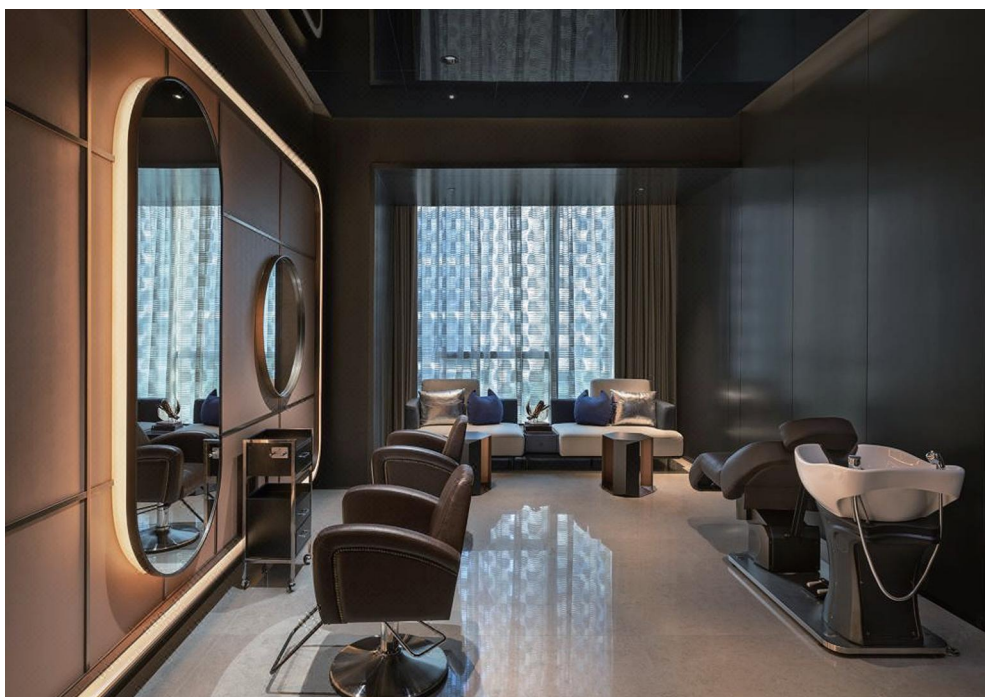

DuraGreen project:
Westin Hotel



W system	lm system	optics	code
20W	1407	24°	MF10020W-30N24-W
20W	1420	36°	MF10020W-30N36-W
20W	1411	50°	MF10020W-30N50-W



W system	lm system	optics	code
25W	1777	24°	MF10025W-30N24-W
25W	1797	36°	MF10025W-30N36-W
25W	1764	50°	MF10025W-30N50-W



W system	lm system	optics	code
30W	2028	24°	MF10030W-30N24-W
30W	2071	36°	MF10030W-30N36-W
30W	2067	50°	MF10030W-30N50-W



W system	lm system	optics	code
40W	2395	24°	MF10040W-30N24-W
40W	2465	36°	MF10040W-30N36-W
40W	2419	50°	MF10040W-30N50-W

MOOD DOWNLIGHT

Φ100 Adjustable Round



view on website



cutout :100mm



Adjustable Optic

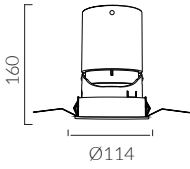

- IP Rating:** IP20 and IP44 options
- Optics:** 15°/24°/36°/50°
- UGR:** <10
- CRI:** 98Ra
- Lifetime:** >50,000 hrs (L70 B10)
- CCT:** 2700K/3000K/3500K/4000K/5000K
- Typical Source**
- Efficacy (lm/W):** 110
- Control:** On/off, Mains Dim, 0/1-10V, DALI, Zigbee, Casambi
- Binning:** 2 Step MacAdams
- Input:** AC220-240V 50/60Hz
- Output:** DC 36V 500mA 20W
DC 36V 600mA 25W
DC 36V 750mA 30W
DC 36V 1000mA 40W
- Ambient temp:** -20 °C to 45 °C
- Class:** II
- Optional accessories:** Honeycomb louvre, Solite Lense, Spread Lense, Colour Filter

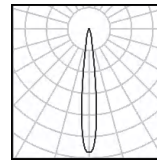

30W Ra98 3000K 15°

h(m)	E(lx)	D(m)
1.0	8966	0.28
2.0	2247	0.58
3.0	998	0.84
4.0	562	1.10
5.0	359	1.40
6.0	250	1.70

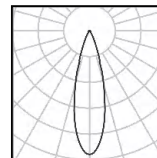

30W Ra98 3000K 24°

h(m)	E(lx)	D(m)
1.0	5888	0.39
2.0	1457	0.77
3.0	652	1.20
4.0	367	1.50
5.0	235	1.90
6.0	163	2.30

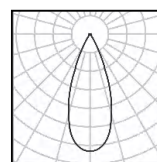

30W Ra98 3000K 36°

h(m)	E(lx)	D(m)
1.0	2991	0.54
2.0	748	1.10
3.0	332	1.60
4.0	187	2.20
5.0	120	2.70
6.0	83	3.20



DuraGreen project:
Hua Tian Hotel



W system	lm system	optics	code
20W	1304	15°	AFL10020W-30N15-W
20W	1364	24°	AFL10020W-30N24-W
20W	1312	36°	AFL10020W-30N36-W
20W	1369	50°	AFL10020W-30N50-W



W system	lm system	optics	code
25W	1595	15°	AFL10025W-30N15-W
25W	1696	24°	AFL10025W-30N24-W
25W	1676	36°	AFL10025W-30N36-W
25W	1715	50°	AFL10025W-30N50-W



W system	lm system	optics	code
30W	1872	15°	AFL10030W-30N15-W
30W	1940	24°	AFL10030W-30N24-W
30W	1841	36°	AFL10030W-30N36-W
30W	1962	50°	AFL10030W-30N50-W



W system	lm system	optics	code
40W	1975	15°	AFL10040W-30N15-W
40W	2088	24°	AFL10040W-30N24-W
40W	2105	36°	AFL10040W-30N36-W
40W	2380	50°	AFL10040W-30N50-W

MOOD DOWNLIGHT

Φ 100

Trimless Adjustable Round



view on website



cutout : 100mm



Adjustable Optic

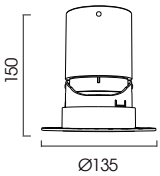

IP Rating:	IP20 and IP44 options
Optics:	10°/24°/36°/50°
UGR:	< 10
CRI:	98Ra
Lifetime:	> 50,000 hrs (L70 B10)
CCT:	2700K/3000K/3500K/4000K/5000K
Typical Source Efficacy (lm/W):	110
Control:	On/off, Mains Dim, 0/1-10V, Dali, Zigbee, Casambi
Binning:	2 Step MacAdams
Input:	AC220-240V 50/60Hz
Output:	DC 36V 500mA 20W DC 36V 600mA 25W DC 36V 750mA 30W DC 36V 1000mA 40W
Ambient temp:	-20 °C to 45 °C
Class:	II
Optional accessories:	Honeycomb louvre, Solite Lense, Spread Lense, Colour Filter

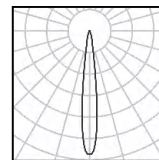

30W Ra98 3000K 15°

h(m)	E(lx)	D(m)
1.0	8966	0.28
2.0	2247	0.58
3.0	998	0.84
4.0	562	1.10
5.0	359	1.40
6.0	250	1.70

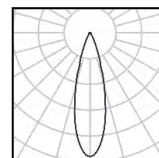

30W Ra98 3000K 24°

h(m)	E(lx)	D(m)
1.0	5888	0.39
2.0	1457	0.77
3.0	652	1.20
4.0	367	1.50
5.0	235	1.90
6.0	163	2.30

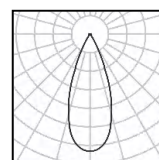

30W Ra98 3000K 36°

h(m)	E(lx)	D(m)
1.0	2991	0.54
2.0	748	1.10
3.0	332	1.60
4.0	187	2.20
5.0	120	2.70
6.0	83	3.20



DuraGreen project:
Poliform Showroom



W system	lm system	optics	code
20W	1304	15°	AFL10020W-TL-30N15-W
20W	1364	24°	AFL10020W-TL-30N24-W
20W	1312	36°	AFL10020W-TL-30N36-W
20W	1369	50°	AFL10020W-TL-30N50-W



W system	lm system	optics	code
25W	1595	15°	AFL10025W-TL-30N15-W
25W	1696	24°	AFL10025W-TL-30N24-W
25W	1676	36°	AFL10025W-TL-30N36-W
25W	1715	50°	AFL10025W-TL-30N50-W



W system	lm system	optics	code
30W	1872	15°	AFL10030W-TL-30N15-W
30W	1940	24°	AFL10030W-TL-30N24-W
30W	1841	36°	AFL10030W-TL-30N36-W
30W	1962	50°	AFL10030W-TL-30N50-W



W system	lm system	optics	code
40W	1975	15°	AFL10040W-TL-30N15-W
40W	2088	24°	AFL10040W-TL-30N24-W
40W	2105	36°	AFL10040W-TL-30N36-W
40W	2380	50°	AFL10040W-TL-30N50-W

MOOD PINHOLE

Φ58 Adjustable Round



view on website



cutout :58mm



Adjustable Optic

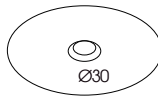
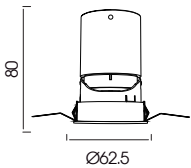

IP Rating:	IP20 and IP44 options
Optics:	10°/24°/36°/50°
UGR:	<10
CRI:	98Ra
Lifetime:	>50,000 hrs (L70 B10)
CCT:	2700K/3000K/3500K/4000K/5000K/ 2000K-3000K/1800K-4000K/2700K-6000K

Typical Source	
Efficacy (lm/W):	110
Control:	On/off, Mains Dim, 0/1-10V, Dali, Zigbee, Casambi
Binning:	2 Step MacAdams
Input:	AC220-240V 50/60Hz
Output:	DC 36V 150mA 6W DC 36V 200mA 8W DC 36V 250mA 10W

Ambient temp: -20 °C to 45 °C

Class: II

Optional accessories: Honeycomb louvre, Solite Lense, Spread Lense, Colour Filter

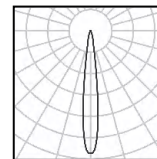

10W Ra98 3000K 10°

h(m)	E lx	D(m)
0.5	8431	0.11
1.0	2108	0.21
1.5	937	0.32
2.0	527	0.43
2.5	337	0.53
3.0	234	0.64

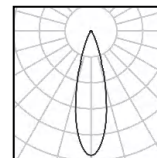

10W Ra98 3000K 24°

h(m)	E lx	D(m)
0.5	4847	0.21
1.0	1212	0.43
1.5	539	0.64
2.0	303	0.86
2.5	194	1.07
3.0	135	1.29

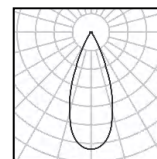

10W Ra98 3000K 36°

h(m)	E lx	D(m)
0.5	2553	0.32
1.0	638	0.65
1.5	284	0.97
2.0	160	1.29
2.5	102	1.61
3.0	71	1.94



DuraGreen project:
Black Stone Hillside Hotel

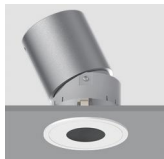

W system	lm system	optics	code
6W	328	10°	AFP6006W-30N10-W
6W	407	24°	AFP6006W-30N24-W
6W	417	36°	AFP6006W-30N36-W
6W	411	50°	AFP6006W-30N50-W

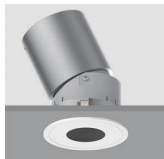

W system	lm system	optics	code
8W	384	10°	AFP6008W-30N10-W
8W	501	24°	AFP6008W-30N24-W
8W	517	36°	AFP6008W-30N36-W
8W	512	50°	AFP6008W-30N50-W



W system	lm system	optics	code
10W	411	10°	AFP6010W-30N10-W
10W	554	24°	AFP6010W-30N24-W
10W	567	36°	AFP6010W-30N36-W
10W	558	50°	AFP6010W-30N50-W

MOOD PINHOLE

Φ58 Adjustable Round



cutout :58mm



Adjustable Optic

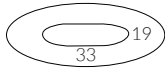
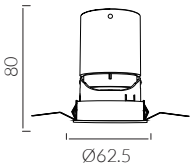

view on website

IP Rating: IP20 and IP44 options
Optics: 10°/24°/36°/50°
UGR: < 10
CRI: 98Ra
Lifetime: >50,000 hrs (L70 B10)
CCT: 2700K/3000K/3500K/4000K/5000K/
 2000K-3000K/1800K-4000K/2700K-6000K

Typical Source
Efficacy (lm/W): 110
Control: On/off, Mains Dim, 0/1-10V, Dali, Zigbee, Casambi
Binning: 2 Step MacAdams
Input: AC220-240V 50/60Hz
Output: DC 36V 150mA 6W
 DC 36V 200mA 8W
 DC 36V 250mA 10W

Ambient temp: -20 °C to 45 °C

Class: II

Optional accessories: Honeycomb louvre, Solite Lense, Spread Lense,
 Colour Filter

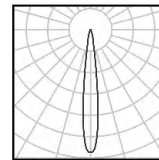

10W Ra98 3000K 10°

h(m)	E lx	D(m)
0.5	8431	0.11
1.0	2108	0.21
1.5	937	0.32
2.0	527	0.43
2.5	337	0.53
3.0	234	0.64

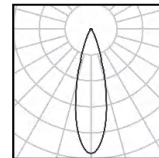

10W Ra98 3000K 24°

h(m)	E lx	D(m)
0.5	4847	0.21
1.0	1212	0.43
1.5	539	0.64
2.0	303	0.86
2.5	194	1.07
3.0	135	1.29

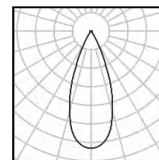

10W Ra98 3000K 36°

h(m)	E lx	D(m)
0.5	2553	0.32
1.0	638	0.65
1.5	284	0.97
2.0	160	1.29
2.5	102	1.61
3.0	71	1.94



DuraGreen project:
Yacht Hotel

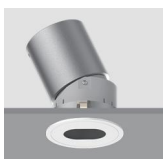

W system	lm system	optics	code
6W	328	10°	AFO6006W-30N10-W
6W	407	24°	AFO6006W-30N24-W
6W	417	36°	AFO6006W-30N36-W
6W	411	50°	AFO6006W-30N50-W



W system	lm system	optics	code
8W	384	10°	AFO6008W-30N10-W
8W	501	24°	AFO6008W-30N24-W
8W	517	36°	AFO6008W-30N36-W
8W	512	50°	AFO6008W-30N50-W



W system	lm system	optics	code
10W	411	10°	AFO6010W-30N10-W
10W	554	24°	AFO6010W-30N24-W
10W	567	36°	AFO6010W-30N36-W
10W	558	50°	AFO6010W-30N50-W

MOOD PINHOLE

Φ75 Adjustable Round



cutout :75mm



Adjustable Optic



[view on website](#)

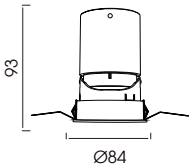

IP Rating: IP20 and IP44 options
Optics: 12°/20°/29°/44°
UGR: < 10
CRI: 98Ra
Lifetime: > 50,000 hrs (L70 B10)
CCT: 2700K/3000K/3500K/4000K/5000K/
 2000K-3000K/1800K-4000K/2700K-6000K

Typical Source
Efficacy (lm/W): 110
Control: On/off, Mains Dim, 0/1-10V, Dali, Zigbee, Casambi
Binning: 2 Step MacAdams
Input: AC220-240V 50/60Hz
Output: DC 36V 200mA 8W
 DC 36V 250mA 10W
 DC 36V 300mA 12W
 DC 36V 350mA 15W

Ambient temp: -20 °C to 45 °C

Class: II

Optional accessories: Honeycomb louvre, Solite Lense, Spread Lense, Colour Filter

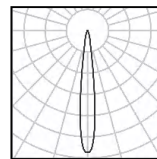

15W Ra98 3000K 10°

h(m)	E(lx)	D(m)
0.5	14433	0.10
1.0	3608	0.21
1.5	1604	0.31
2.0	902	0.41
2.5	577	0.52
3.0	401	0.62

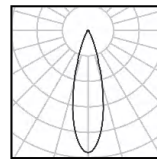

15W Ra98 3000K 20°

h(m)	E(lx)	D(m)
0.5	7982	0.18
1.0	1995	0.35
1.5	887	0.53
2.0	499	0.71
2.5	319	0.88
3.0	222	1.06

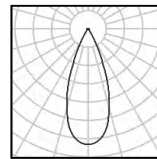

15W Ra98 3000K 29°

h(m)	E(lx)	D(m)
0.5	5441	0.25
1.0	1360	0.51
1.5	605	0.76
2.0	340	1.02
2.5	218	1.27
3.0	151	1.53

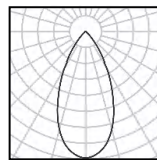

15W Ra98 3000K 44°

h(m)	E(lx)	D(m)
0.5	2008	0.38
1.0	502	0.76
1.5	223	1.15
2.0	126	1.53
2.5	80	1.91
3.0	56	2.29

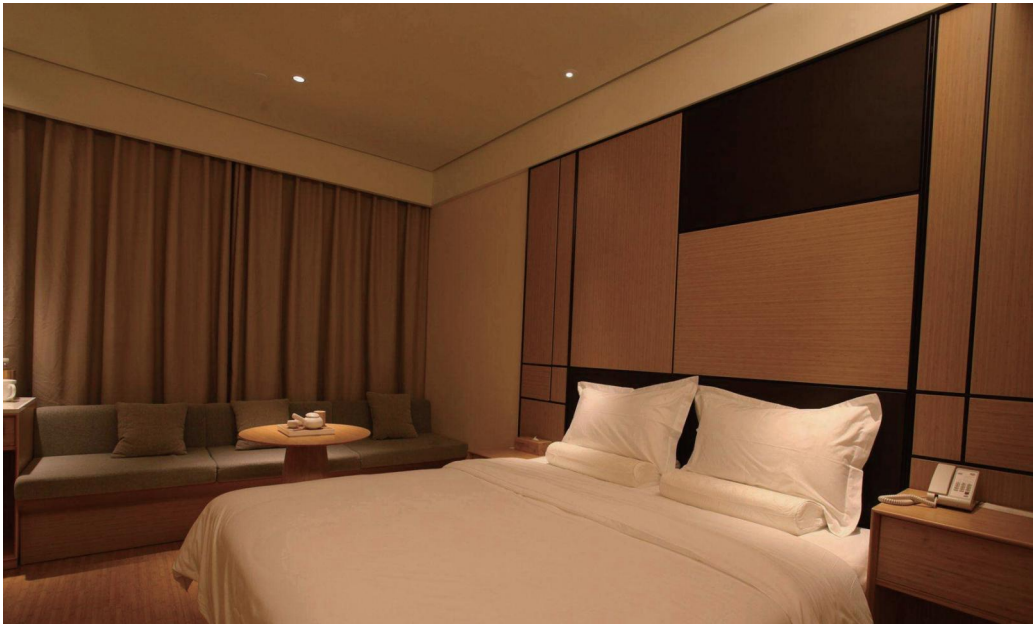

DuraGreen project:
Fang Yuan Hotel



W system	lm system	optics	code
8W	364	12°	AF7508W-P-30N12-W
8W	400	20°	AF7508W-P-30N20-W
8W	506	29°	AF7508W-P-30N29-W
8W	460	44°	AF7508W-P-30N44-W



W system	lm system	optics	code
10W	428	12°	AF7510W-P-30N12-W
10W	481	20°	AF7510W-P-30N20-W
10W	597	29°	AF7510W-P-30N29-W
10W	540	44°	AF7510W-P-30N44-W



W system	lm system	optics	code
12W	504	12°	AF7512W-P-30N12-W
12W	565	20°	AF7512W-P-30N20-W
12W	704	29°	AF7512W-P-30N29-W
12W	632	44°	AF7512W-P-30N44-W



W system	lm system	optics	code
15W	585	12°	AF7515W-P-30N12-W
15W	642	20°	AF7515W-P-30N20-W
15W	805	29°	AF7515W-P-30N29-W
15W	718	44°	AF7515W-P-30N44-W

MOOD PINHOLE

Φ75 Adjustable Round



cutout :75mm



Adjustable Optic



view on website

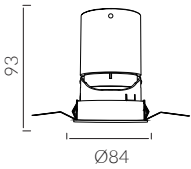

IP Rating: IP20 and IP44 options
Optics: 12°/20°/29°/44°
UGR: < 10
CRI: 98Ra
Lifetime: >50,000 hrs (L70 B10)
CCT: 2700K/3000K/3500K/4000K/5000K/
 2000K-3000K/1800K-4000K/2700K-6000K

Typical Source
Efficacy (lm/W): 110
Control: On/off, Mains Dim, 0/1-10V, Dali, Zigbee, Casambi
Binning: 2 Step MacAdams
Input: AC220-240V 50/60Hz
Output: DC 36V 200mA 8W
 DC 36V 250mA 10W
 DC 36V 300mA 12W
 DC 36V 350mA 15W

Ambient temp: -20 °C to 45 °C

Class: II

Optional accessories: Honeycomb louvre, Solite Lense, Spread Lense, Colour Filter

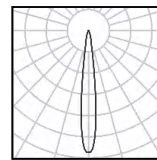

15W Ra98 3000K 10°

h(m)	E(lx)	D(m)
0.5	14433	0.10
1.0	3608	0.21
1.5	1604	0.31
2.0	902	0.41
2.5	577	0.52
3.0	401	0.62

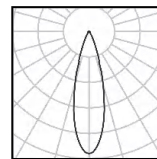

15W Ra98 3000K 20°

h(m)	E(lx)	D(m)
0.5	7982	0.18
1.0	1995	0.35
1.5	887	0.53
2.0	499	0.71
2.5	319	0.88
3.0	222	1.06

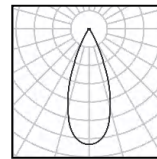

15W Ra98 3000K 29°

h(m)	E(lx)	D(m)
0.5	5441	0.25
1.0	1360	0.51
1.5	605	0.76
2.0	340	1.02
2.5	218	1.27
3.0	151	1.53

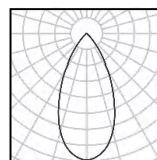

15W Ra98 3000K 44°

h(m)	E(lx)	D(m)
0.5	2008	0.38
1.0	502	0.76
1.5	223	1.15
2.0	126	1.53
2.5	80	1.91
3.0	56	2.29

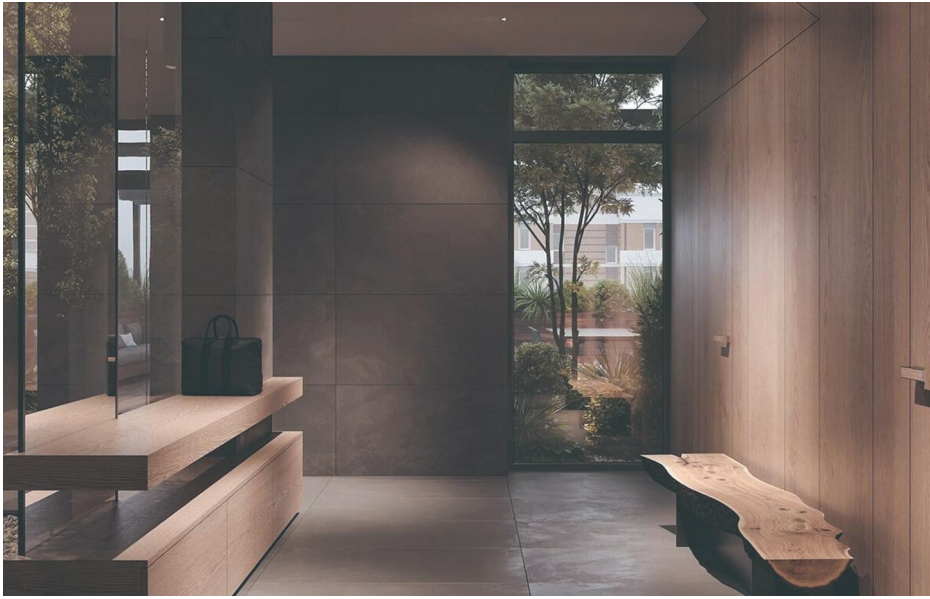

DuraGreen project:
Private Residence



W system	lm system	optics	code
8W	364	12°	AF7508W-O-30N12-W
8W	400	20°	AF7508W-O-30N20-W
8W	506	29°	AF7508W-O-30N29-W
8W	460	44°	AF7508W-O-30N44-W



W system	lm system	optics	code
10W	428	12°	AF7510W-O-30N12-W
10W	481	20°	AF7510W-O-30N20-W
10W	597	29°	AF7510W-O-30N29-W
10W	540	44°	AF7510W-O-30N44-W



W system	lm system	optics	code
12W	504	12°	AF7512W-O-30N12-W
12W	565	20°	AF7512W-O-30N20-W
12W	704	29°	AF7512W-O-30N29-W
12W	632	44°	AF7512W-O-30N44-W



W system	lm system	optics	code
15W	585	12°	AF7515W-O-30N12-W
15W	642	20°	AF7515W-O-30N20-W
15W	805	29°	AF7515W-O-30N29-W
15W	718	44°	AF7515W-O-30N44-W

MOOD SQUARE

▣ 60*60 Adjustable Square



view on website

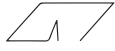

cutout :60*60mm



Adjustable Optic



Wall Wash optic

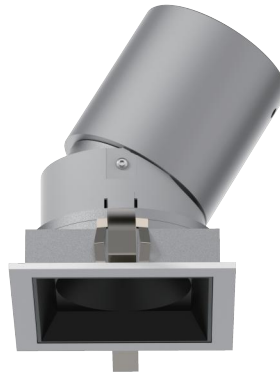

Wall Wash

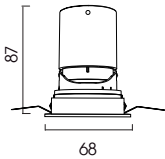

IP Rating:	IP20 and IP44 options
Optics:	10°/24°/36°/50°/Wall Wash
UGR:	< 10
CRI:	98Ra
Lifetime:	>50,000 hrs (L70 B10)
CCT:	2700K/3000K/3500K/4000K/5000K/ 2000K-3000K/1800K-4000K/2700K-6000K

Typical Source	
Efficacy (lm/W):	110
Control:	On/off, Mains Dim, 0/1-10V, Dali, Zigbee, Casambi
Binning:	2 Step MacAdams
Input:	AC220-240V 50/60Hz
Output:	DC 36V 150mA 6W DC 36V 200mA 8W DC 36V 250mA 10W

Ambient temp: -20 °C to 45 °C

Class: II

Optional accessories: Honeycomb louvre, Solite Lense, Spread Lense,
Colour Filter

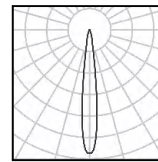

10W Ra98 3000K 10°

h(m)	E(lx)	D(m)
0.5	8431	0.11
1.0	2108	0.21
1.5	937	0.32
2.0	527	0.43
2.5	337	0.53
3.0	234	0.64

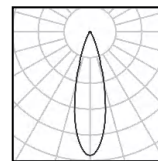

10W Ra98 3000K 24°

h(m)	E(lx)	D(m)
0.5	4847	0.21
1.0	1212	0.43
1.5	539	0.64
2.0	303	0.86
2.5	194	1.07
3.0	135	1.29

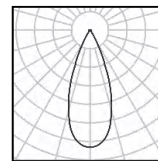

10W Ra98 3000K 36°

h(m)	E(lx)	D(m)
0.5	2553	0.32
1.0	638	0.65
1.5	284	0.97
2.0	160	1.29
2.5	102	1.61
3.0	71	1.94

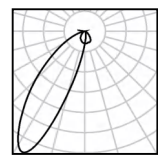

10W Ra98 3000K
Asymmetrical

h(m)	E(lx)	D(m)
0.5	1338	0.37
1.0	335	0.74
1.5	149	1.12
2.0	84	1.49
2.5	54	1.86
3.0	34	2.23



DuraGreen project:
One Shenzhen Bay Residence

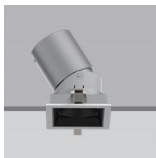

W system	lm system	optics	code
6W	328	10°	AFQ6006W-30N10-W
6W	407	24°	AFQ6006W-30N24-W
6W	417	36°	AFQ6006W-30N36-W
6W	411	50°	AFQ6006W-30N50-W

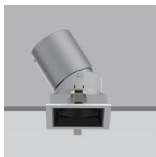

W system	lm system	optics	code
8W	384	10°	AFQ6008W-30N10-W
8W	501	24°	AFQ6008W-30N24-W
8W	517	36°	AFQ6008W-30N36-W
8W	512	50°	AFQ6008W-30N50-W

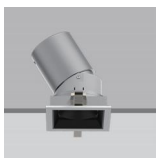

W system	lm system	optics	code
10W	411	10°	AFQ6010W-30N10-W
10W	554	24°	AFQ6010W-30N24-W
10W	567	36°	AFQ6010W-30N36-W
10W	558	50°	AFQ6010W-30N50-W



W system	lm system	optics	code
10W	442	Wall Wash	AFQ6010W-30NWS-W

MOOD SQUARE

▣ 60*120 Adjustable Square



view on website



cutout :60*120mm



Adjustable Optic

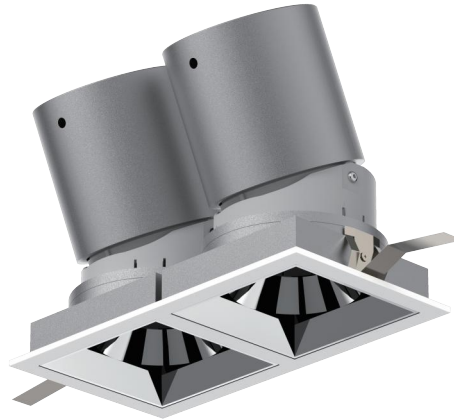
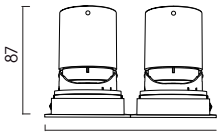

- IP Rating:** IP20 and IP44 options
- Optics:** 10°/24°/36°/50°
- UGR:** <10
- CRI:** 98Ra
- Lifetime:** >50,000 hrs (L70 B10)
- CCT:** 2700K/3000K/3500K/4000K/5000K/
2000K-3000K/1800K-4000K/2700K-6000K
- Typical Source Efficacy (lm/W):** 110
- Control:** On/off, Mains Dim, 0/1-10V, Dali, Zigbee, Casambi
- Binning:** 2 Step MacAdams
- Input:** AC220-240V 50/60Hz
- Output:** DC 36V 150mA 6W*2
DC 36V 200mA 8W*2
DC 36V 250mA 10W*2
- Ambient temp:** -20 °C to 45 °C
- Class:** II
- Optional accessories:** Honeycomb louvre, Solite Lense, Spread Lense,
Colour Filter

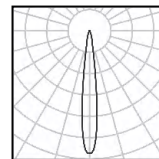

10W Ra98 3000K 10°

h(m)	E(lx)	D(m)
0.5	8431	0.11
1.0	2108	0.21
1.5	937	0.32
2.0	527	0.43
2.5	337	0.53
3.0	234	0.64

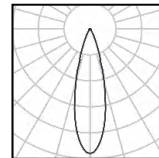

10W Ra98 3000K 24°

h(m)	E(lx)	D(m)
0.5	4847	0.21
1.0	1212	0.43
1.5	539	0.64
2.0	303	0.86
2.5	194	1.07
3.0	135	1.29

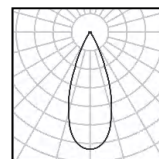

10W Ra98 3000K 36°

h(m)	E(lx)	D(m)
0.5	2553	0.32
1.0	638	0.65
1.5	284	0.97
2.0	160	1.29
2.5	102	1.61
3.0	71	1.94



DuraGreen project:
One Shenzhen Bay Residence



W system	lm system	optics	code
6W*2	328*2	10°	AFQ6006WX2-30N10-W
6W*2	407*2	24°	AFQ6006WX2-30N24-W
6W*2	417*2	36°	AFQ6006WX2-30N36-W
6W*2	411*2	50°	AFQ6006WX2-30N50-W



W system	lm system	optics	code
8W*2	384*2	10°	AFQ6008WX2-30N10-W
8W*2	501*2	24°	AFQ6008WX2-30N24-W
8W*2	517*2	36°	AFQ6008WX2-30N36-W
8W*2	512*2	50°	AFQ6008WX2-30N50-W



W system	lm system	optics	code
10W*2	411*2	10°	AFQ6010WX2-30N10-W
10W*2	554*2	24°	AFQ6010WX2-30N24-W
10W*2	567*2	36°	AFQ6010WX2-30N36-W
10W*2	558*2	50°	AFQ6010WX2-30N50-W

MOOD SQUARE

∅ 60*180 Adjustable Square



cutout :60*180mm



Adjustable Optic

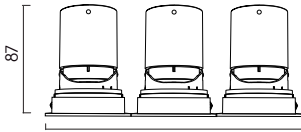

188



[view on website](#)

- IP Rating:** IP20 and IP44 options
Optics: 10°/24°/36°/50°
UGR: <10
CRI: 98Ra
Lifetime: >50,000 hrs (L70 B10)
CCT: 2700K/3000K/3500K/4000K/5000K/
 2000K-3000K/1800K-4000K/2700K-6000K
- Typical Source**
Efficacy (lm/W): 110
Control: On/off, Mains Dim, 0/1-10V, Dali, Zigbee, Casambi
Binning: 2 Step MacAdams
Input: AC220-240V 50/60Hz
Output: DC 36V 150mA 6W*3
 DC 36V 200mA 8W*3
 DC 36V 250mA 10W*3
- Ambient temp:** -20 °C to 45 °C
Class: II
Optional accessories: Honeycomb louvre, Solite Lense, Spread Lense,
 Colour Filter

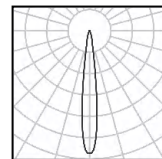

10W Ra98 3000K 10°

h(m)	E(lx)	D(m)
0.5	8431	0.11
1.0	2108	0.21
1.5	937	0.32
2.0	527	0.43
2.5	337	0.53
3.0	234	0.64

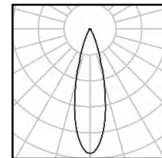

10W Ra98 3000K 24°

h(m)	E(lx)	D(m)
0.5	4847	0.21
1.0	1212	0.43
1.5	539	0.64
2.0	303	0.86
2.5	194	1.07
3.0	135	1.29

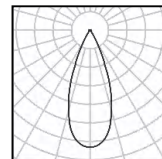

10W Ra98 3000K 36°

h(m)	E(lx)	D(m)
0.5	2553	0.32
1.0	638	0.65
1.5	284	0.97
2.0	160	1.29
2.5	102	1.61
3.0	71	1.94



W system	lm system	optics	code
6W*3	328*3	10°	AFQ6006WX3-30N10-W
6W*3	407*3	24°	AFQ6006WX3-30N24-W
6W*3	417*3	36°	AFQ6006WX3-30N36-W
6W*3	411*3	50°	AFQ6006WX3-30N50-W



W system	lm system	optics	code
8W*3	384*3	10°	AFQ6008WX3-30N10-W
8W*3	501*3	24°	AFQ6008WX3-30N24-W
8W*3	517*3	36°	AFQ6008WX3-30N36-W
8W*3	512*3	50°	AFQ6008WX3-30N50-W



W system	lm system	optics	code
10W*3	411*3	10°	AFQ6010WX3-30N10-W
10W*3	554*3	24°	AFQ6010WX3-30N24-W
10W*3	567*3	36°	AFQ6010WX3-30N36-W
10W*3	558*3	50°	AFQ6010WX3-30N50-W

MOOD SQUARE

SUPERSEDED

◻ 68*68 Trimless Adjustable Square



cutout :68*68mm



Adjustable Optic

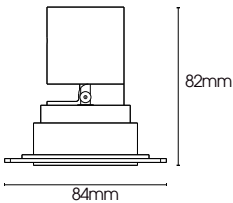

IP Rating: IP20 and IP44 options
Optics: 10°/24°/36°/50°
UGR: <10
CRI: 98Ra
Lifetime: >50,000 hrs (L70 B10)
CCT: 2700K/3000K/3500K/4000K/5000K/2000K-3000K/
 1800K-4000K/2700K-6000K

Typical Source
Efficacy (lm/W): 110
Control: On/off, Mains Dim, 0/1-10V, DALI, Zigbee, Casambi
Binning: 2 Step MacAdams
Input: AC220-240V 50/60Hz
Output: DC 36V 150mA 6W
 DC 36V 200mA 8W
 DC 36V 250mA 10W

Ambient temp: -20 °C to 45 °C
Class: II

Optional accessories: Honeycomb louvre, Solite Lense, Spread Lense, Colour Filter

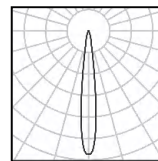

10W Ra98 3000K 10°

h(m)	E(lx)	D(m)
0.5	8431	0.11
1.0	2108	0.21
1.5	937	0.32
2.0	527	0.43
2.5	337	0.53
3.0	234	0.64

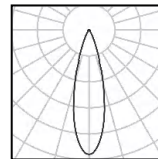

10W Ra98 3000K 24°

h(m)	E(lx)	D(m)
0.5	4847	0.21
1.0	1212	0.43
1.5	539	0.64
2.0	303	0.86
2.5	194	1.07
3.0	135	1.29

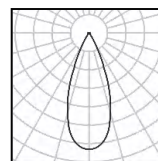

10W Ra98 3000K 36°

h(m)	E(lx)	D(m)
0.5	2553	0.32
1.0	638	0.65
1.5	284	0.97
2.0	160	1.29
2.5	102	1.61
3.0	71	1.94

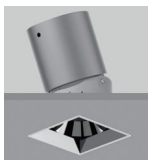

W system	lm system	optics	code
6W	328	10°	AFQ6806W-TL-30N10-W
6W	407	24°	AFQ6806W-TL-30N24-W
6W	417	36°	AFQ6806W-TL-30N36-W
6W	411	50°	AFQ6806W-TL-30N50-W

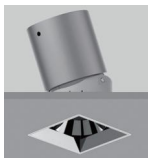

W system	lm system	optics	code
8W	384	10°	AFQ6808W-TL-30N10-W
8W	501	24°	AFQ6808W-TL-30N24-W
8W	517	36°	AFQ6808W-TL-30N36-W
8W	512	50°	AFQ6808W-TL-30N50-W

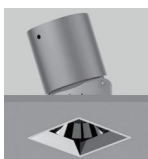

W system	lm system	optics	code
10W	411	10°	AFQ6810W-TL-30N10-W
10W	554	24°	AFQ6810W-TL-30N24-W
10W	567	36°	AFQ6810W-TL-30N36-W
10W	558	50°	AFQ6810W-TL-30N50-W

MOOD SQUARE

SUPERSEDED

∅ 68*118 Trimless Adjustable Square



cutout :68*118mm



Adjustable Optic

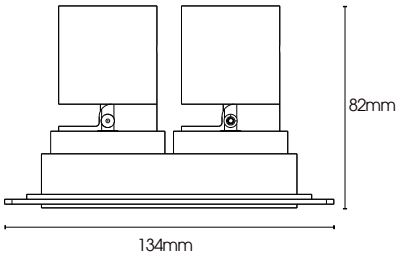

- IP Rating:** IP20 and IP44 options
- Optics:** 10°/24°/36°/50°
- UGR:** < 10
- CRI:** 98Ra
- Lifetime:** > 50,000 hrs (L70 B10)
- CCT:** 2700K/3000K/3500K/4000K/5000K/
2000K-3000K/1800K-4000K/2700K-6000K

- Typical Source**
- Efficacy (lm/W):** 110
- Control:** On/off, Mains Dim, 0/1-10V, Dali, Zigbee, Casambi
- Binning:** 2 Step MacAdams
- Input:** AC220-240V 50/60Hz
- Output:** DC 36V 150mA 6W*2
DC 36V 200mA 8W*2
DC 36V 250mA 10W*2

- Ambient temp:** -20 °C to 45 °C
- Class:** II

- Optional accessories:** Honeycomb louvre, Solite Lense, Spread Lense, Colour Filter

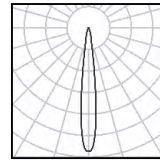

10W Ra98 3000K 10°

h(m)	E(lx)	D(m)
0.5	8431	0.11
1.0	2108	0.21
1.5	937	0.32
2.0	527	0.43
2.5	337	0.53
3.0	234	0.64

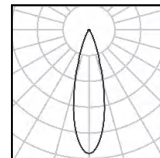

10W Ra98 3000K 24°

h(m)	E(lx)	D(m)
0.5	4847	0.21
1.0	1212	0.43
1.5	539	0.64
2.0	303	0.86
2.5	194	1.07
3.0	135	1.29

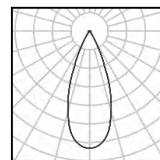

10W Ra98 3000K 36°

h(m)	E(lx)	D(m)
0.5	2553	0.32
1.0	638	0.65
1.5	284	0.97
2.0	160	1.29
2.5	102	1.61
3.0	71	1.94



DuraGreen project:
London Luxury Home



W system	lm system	optics	code
6W*2	328*2	10°	AFQ6806WX2-TL-30N10-W
6W*2	407*2	24°	AFQ6806WX2-TL-30N24-W
6W*2	417*2	36°	AFQ6806WX2-TL-30N36-W
6W*2	411*2	50°	AFQ6806WX2-TL-30N50-W



W system	lm system	optics	code
8W*2	384*2	10°	AFQ6808WX2-TL-30N10-W
8W*2	501*2	24°	AFQ6808WX2-TL-30N24-W
8W*2	517*2	36°	AFQ6808WX2-TL-30N36-W
8W*2	512*2	50°	AFQ6808WX2-TL-30N50-W



W system	lm system	optics	code
10W*2	411*2	10°	AFQ6810WX2-TL-30N10-W
10W*2	554*2	24°	AFQ6810WX2-TL-30N24-W
10W*2	567*2	36°	AFQ6810WX2-TL-30N36-W
10W*2	558*2	50°	AFQ6810WX2-TL-30N50-W

MOOD SQUARE

▣ 80*80 Adjustable Square



cutout :80*80mm



Adjustable Optic



view on website

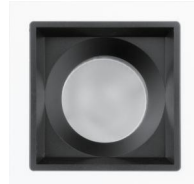
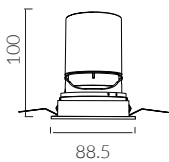

Wall Wash

- IP Rating:** IP20 and IP44 options
Optics: 10°/24°/36°/50°/Wall Wash
UGR: < 10
CRI: 98Ra
Lifetime: > 50,000 hrs (L70 B10)
CCT: 2700K/3000K/3500K/4000K/5000K/2000K-3000K/
1800K-4000K/2700K-6000K
- Typical Source Efficacy (lm/W):** 110
- Control:** On/off, Mains Dim, 0/1-10V, Dali, Zigbee, Casambi
Binning: 2 Step MacAdams
Input: AC220-240V 50/60Hz
Output: DC 36V 200mA 8W
DC 36V 250mA 10W
DC 36V 300mA 12W
DC 36V 350mA 15W
- Ambient temp:** -20 C to 45 C
Class: II
Optional accessories: Honeycomb louvre, Solite Lense, Spread Lense, Colour Filter

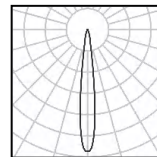

15W Ra98 3000K 10°

h(m)	E(lx)	D(m)
0.5	20026	0.10
1.0	5007	0.19
1.5	2225	0.29
2.0	1252	0.39
2.5	801	0.48
3.0	556	0.58

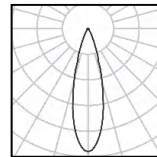

15W Ra98 3000K 24°

h(m)	E(lx)	D(m)
0.5	8899	0.19
1.0	2225	0.38
1.5	989	0.57
2.0	556	0.76
2.5	356	1.95
3.0	247	1.14

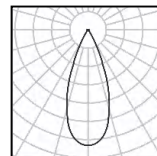

15W Ra98 3000K 36°

h(m)	E(lx)	D(m)
0.5	5184	0.29
1.0	1296	0.57
1.5	576	0.86
2.0	324	1.15
2.5	207	1.43
3.0	144	1.72

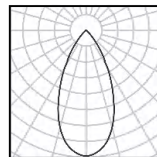

15W Ra98 3000K 50°

h(m)	E(lx)	D(m)
0.5	2095	0.45
1.0	524	0.89
1.5	233	1.34
2.0	131	1.79
2.5	84	2.24
3.0	58	2.68



DuraGreen project:
Private Residence



W system	lm system	optics	code
8W	446	10°	AFQ8008W-30N10-W
8W	495	24°	AFQ8008W-30N24-W
8W	569	36°	AFQ8008W-30N36-W
8W	552	50°	AFQ8008W-30N50-W



W system	lm system	optics	code
10W	522	10°	AFQ8010W-30N10-W
10W	603	24°	AFQ8010W-30N24-W
10W	681	36°	AFQ8010W-30N36-W
10W	657	50°	AFQ8010W-30N50-W



W system	lm system	optics	code
12W	595	10°	AFQ8012W-30N10-W
12W	702	24°	AFQ8012W-30N24-W
12W	795	36°	AFQ8012W-30N36-W
12W	767	50°	AFQ8012W-30N50-W



W system	lm system	optics	code
15W	660	10°	AFQ8015W-30N10-W
15W	794	24°	AFQ8015W-30N24-W
15W	901	36°	AFQ8015W-30N36-W
15W	865	50°	AFQ8015W-30N50-W



W system	lm system	optics	code
12W	590	Wall Wash	AFQW8012W-30NWS-W

MOOD SQUARE

▣ 160*80
Adjustable Square



view on website



cutout : 160*80mm



Adjustable Optic

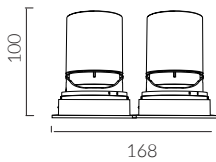
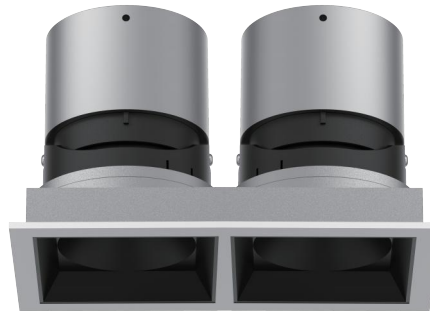

IP Rating: IP20 and IP44 options
Optics: 10°/24°/36°/50°
UGR: <10
CRI: 98Ra
Lifetime: >50,000 hrs (L70 B10)
CCT: 2700K/3000K/3500K/4000K/5000K/
 2000K-3000K/1800K-4000K/2700K-6000K

Typical Source Efficacy (lm/W): 110
Control: On/off, Mains Dim, 0/1-10V, Dali, Zigbee, Casambi
Binning: 2 Step MacAdams
Input: AC220-240V 50/60Hz
Output: DC 36V 200mA 8W*2
 DC 36V 250mA 10W*2
 DC 36V 300mA 12W*2
 DC 36V 350mA 15W*2

Ambient temp: -20 °C to 45 °C
Class: II

Optional accessories: Honeycomb louvre, Solite Lense, Spread Lense, Colour Filter

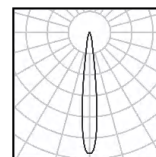

15W Ra98 3000K 10°

h(m)	E(lx)	D(m)
0.5	20026	0.10
1.0	5007	0.19
1.5	2225	0.29
2.0	1252	0.39
2.5	801	0.48
3.0	556	0.58

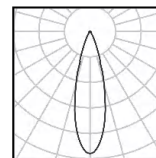

15W Ra98 3000K 24°

h(m)	E(lx)	D(m)
0.5	8899	0.19
1.0	2225	0.38
1.5	989	0.57
2.0	556	0.76
2.5	356	1.95
3.0	247	1.14

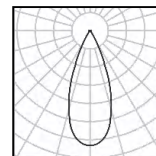

15W Ra98 3000K 36°

h(m)	E(lx)	D(m)
0.5	5184	0.29
1.0	1296	0.57
1.5	576	0.86
2.0	324	1.15
2.5	207	1.43
3.0	144	1.72

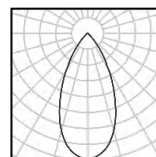

15W Ra98 3000K 50°

h(m)	E(lx)	D(m)
0.5	2095	0.45
1.0	524	0.89
1.5	233	1.34
2.0	131	1.79
2.5	84	2.24
3.0	58	2.68

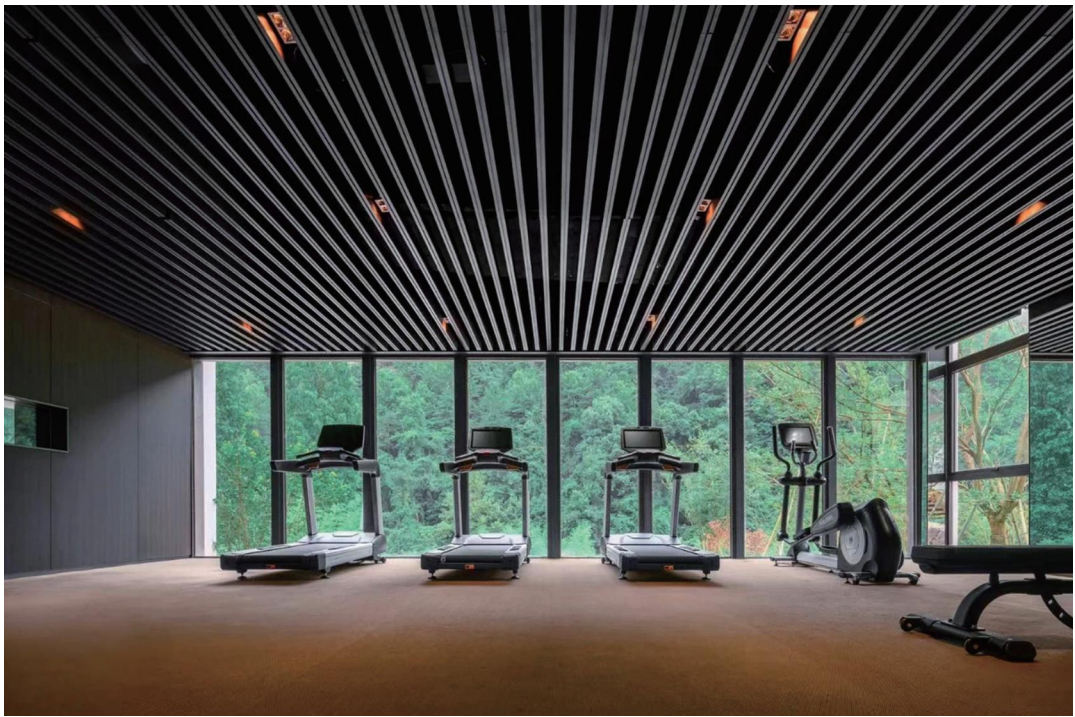

DuraGreen project:
The CHEDI Resort



W system	lm system	optics	code
8W*2	376*2	10°	AFQ8008WX2-30N10-W
8W*2	597*2	24°	AFQ8008WX2-30N24-W
8W*2	590*2	36°	AFQ8008WX2-30N36-W
8W*2	545*2	50°	AFQ8008WX2-30N50-W

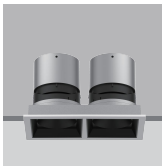

W system	lm system	optics	code
10W*2	445*2	10°	AFQ8010WX2-30N10-W
10W*2	738*2	24°	AFQ8010WX2-30N24-W
10W*2	736*2	36°	AFQ8010WX2-30N36-W
10W*2	672*2	50°	AFQ8010WX2-30N50-W



W system	lm system	optics	code
12W*2	531*2	10°	AFQ8012WX2-30N10-W
12W*2	861*2	24°	AFQ8012WX2-30N24-W
12W*2	851*2	36°	AFQ8012WX2-30N36-W
12W*2	761*2	50°	AFQ8012WX2-30N50-W

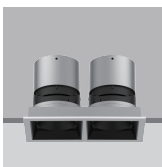

W system	lm system	optics	code
15W*2	568*2	10°	AFQ8015WX2-30N10-W
15W*2	1039*2	24°	AFQ8015WX2-30N24-W
15W*2	1001*2	36°	AFQ8015WX2-30N36-W
15W*2	911*2	50°	AFQ8015WX2-30N50-W

MOOD SHALLOWSHINE

The MOOD ShallowShine downlights from the DuraGreen MOOD range have been specifically designed so they are shorter and more compact to cater to homes and spaces with low ceiling clearance.

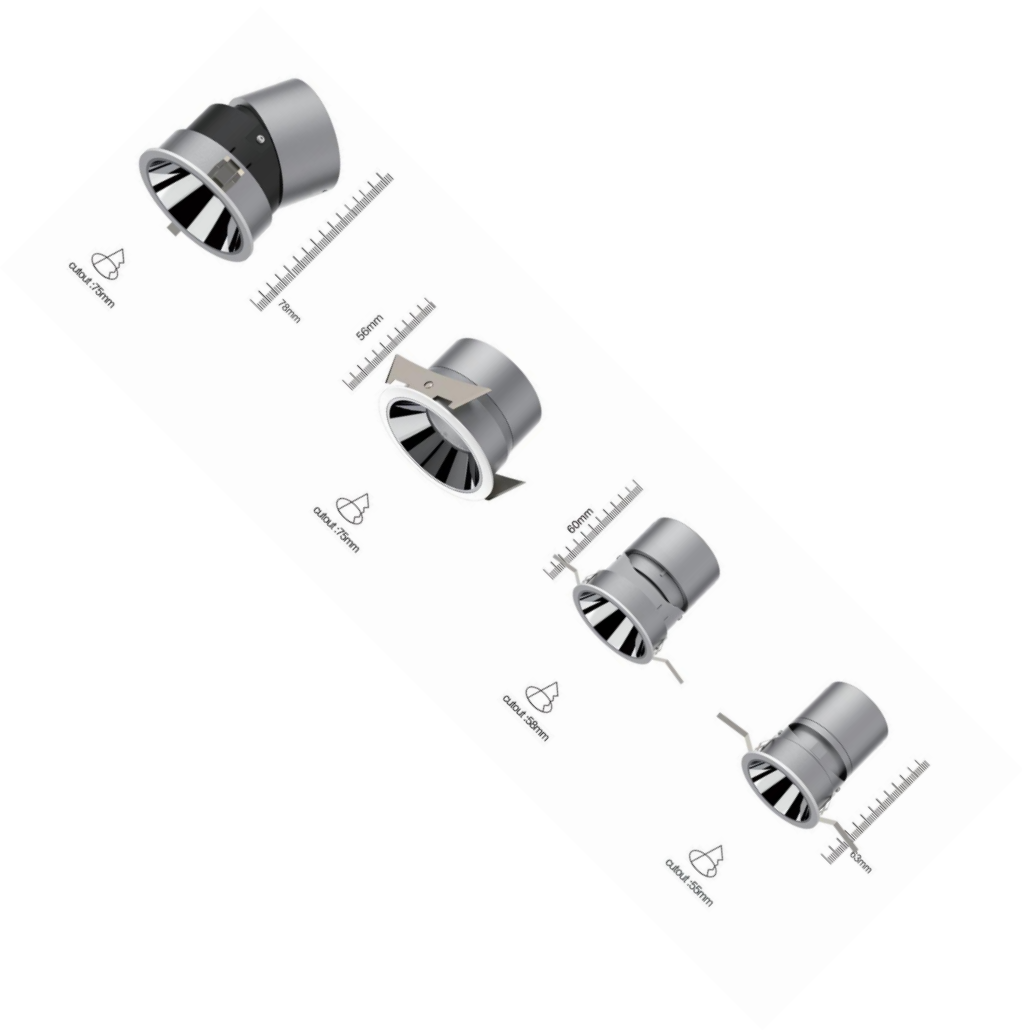

MOOD SHALLOWSHINE

Φ55 Adjustable Round



view on website

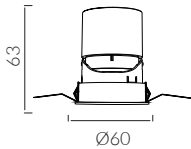

Designed for super eye comfort,
minimum glare

IP Rating:	IP20 and IP44 options
Optics:	10°/24°/36°
UGR:	<10
CRI:	98Ra
Lifetime:	>50,000 hrs (L70 B10)
CCT:	2700K/3000K/3500K/4000K/5000K/ 2000K-3000K/1800K-4000K/2700K-6000K
Typical Source	
Efficacy (lm/W):	110
Control:	On/off, Mains Dim, 0/1-10V, Dali, Zigbee, Casambi
Binning:	2 Step MacAdams
Input:	AC220-240V 50/60Hz
Output:	DC 36V 150mA 6W
Ambient temp:	-20 °C to 45 °C
Class:	II
Optional accessories:	Honeycomb louvre, Solite Lense, Spread Lense, Colour Filter

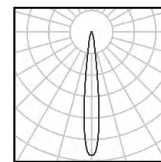

6W Ra98 3000K 10°

h(m)	E(lx)	D(m)
0.5	6661	0.10
1.0	1665	0.20
1.5	740	0.30
2.0	416	0.40
2.5	266	0.50
3.0	185	0.60

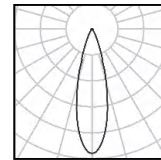

6W Ra98 3000K 24°

h(m)	E(lx)	D(m)
0.5	3558	0.21
1.0	889	0.43
1.5	395	0.64
2.0	222	0.85
2.5	142	1.06
3.0	99	1.28

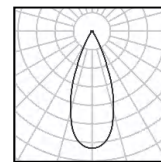

6W Ra98 3000K 36°

h(m)	E(lx)	D(m)
0.5	1865	0.32
1.0	466	0.65
1.5	207	0.97
2.0	117	1.29
2.5	75	1.61
3.0	52	1.94



DuraGreen project:
Yacht Hotel by DC



W system	lm system	optics	code
6W	328	10°	AFL5506W/S-30N10-W
6W	407	24°	AFL5506W/S-30N24-W
6W	417	36°	AFL5506W/S-30N36-W

MOOD SHALLOWSHINE

Φ58 Adjustable Round



view on website



cutout :58mm



Adjustable Optic

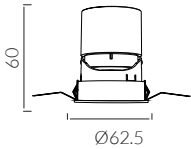

Designed for super eye comfort,
minimum glare

IP Rating:	IP20 and IP44 options
Optics:	10°/24°/36°/50°
UGR:	<10
CRI:	98Ra
Lifetime:	>50,000 hrs (L70 B10)
CCT:	2700K/3000K/3500K/4000K/5000K/ 2000K-3000K/1800K-4000K/2700K-6000K
Typical Source	
Efficacy (lm/W):	110
Control:	On/off, Mains Dim, 0/1-10V, Dali, Zigbee, Casambi
Binning:	2 Step MacAdams
Input:	AC220-240V 50/60Hz
Output:	DC 36V 150mA 6W DC 36V 200mA 8W
Ambient temp:	-20 °C to 45 °C
Class:	II
Optional accessories:	Honeycomb louvre, Solite Lense, Spread Lense, Colour Filter

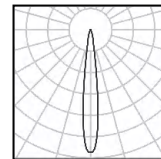

8W Ra98 3000K 10°

h(m)	E(lx)	D(m)
0.5	7812	0.10
1.0	1953	0.20
1.5	868	0.30
2.0	488	0.40
2.5	312	0.50
3.0	217	0.60

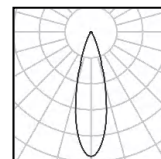

8W Ra98 3000K 24°

h(m)	E(lx)	D(m)
0.5	4392	0.21
1.0	1098	0.43
1.5	488	0.64
2.0	274	0.85
2.5	176	1.06
3.0	122	1.28

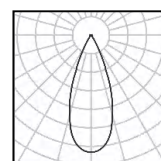

8W Ra98 3000K 36°

h(m)	E(lx)	D(m)
0.5	2345	0.32
1.0	586	0.64
1.5	261	0.96
2.0	147	1.28
2.5	94	1.61
3.0	65	1.93



DuraGreen project:
HYL Luxury Apartment



W system	lm system	optics	code
6W	328	10°	AFL6006W/S-30N10-W
6W	407	24°	AFL6006W/S-30N24-W
6W	417	36°	AFL6006W/S-30N36-W
6W	411	50°	AFL6006W/S-30N50-W



W system	lm system	optics	code
8W	384	10°	AFL6008W/S-30N10-W
8W	501	24°	AFL6008W/S-30N24-W
8W	517	36°	AFL6008W/S-30N36-W
8W	512	50°	AFL6008W/S-30N50-W

MOOD SHALLOWSHINE

Φ75
Fixed Round



view on website



cutout :75mm



Fixed Optic

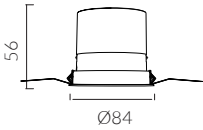

Designed for super eye comfort,
minimum glare

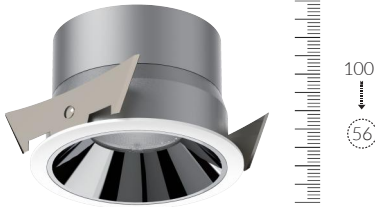

- IP Rating:** IP20 and IP44 options
- Optics:** 24°/36°/50°
- UGR:** <10
- CRI:** 98Ra
- Lifetime:** >50,000 hrs (L70 B10)
- CCT:** 2700K/3000K/3500K/4000K/5000K/
2000K-3000K/1800K-4000K/2700K-6000K
- Typical Source**
- Efficacy (lm/W):** 110
- Control:** On/off, Mains Dim, 0/1-10V, Dali, Zigbee, Casambi
- Binning:** 2 Step MacAdams
- Input:** AC220-240V 50/60Hz
- Output:** DC 36V 200mA 8W
DC 36V 250mA 10W
- Ambient temp:** -20 °C to 45 °C
- Class:** II
- Optional accessories:** Honeycomb louvre, Solite Lense, Spread Lense,
Colour Filter

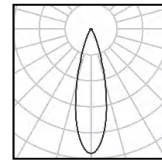

10W Ra98 3000K 24°

h(m)	E lx	D(m)
0.5	6416	0.20
1.0	1604	0.39
1.5	713	0.59
2.0	401	0.78
2.5	257	0.98
3.0	178	1.18

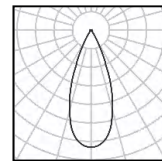

10W Ra98 3000K 36°

h(m)	E lx	D(m)
0.5	3888	0.29
1.0	972	0.59
1.5	432	0.88
2.0	243	1.18
2.5	156	1.47
3.0	108	1.77

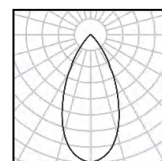

10W Ra98 3000K 50°

h(m)	E lx	D(m)
0.5	1540	0.46
1.0	385	0.92
1.5	171	1.39
2.0	96	1.85
2.5	62	2.31
3.0	43	2.77



DuraGreen project:
LICHIA



W system	lm system	optics	code
8W	598	24°	MFM7508W-30N24-W
8W	632	36°	MFM7508W-30N36-W
8W	573	50°	MFM7508W-30N50-W



W system	lm system	optics	code
10W	618	24°	MFM7510W-30N24-W
10W	699	36°	MFM7510W-30N36-W
10W	650	50°	MFM7510W-30N50-W

MOOD SHALLOWSHINE

Φ75 Adjustable Round



view on website



cutout :75mm



Adjustable Optic

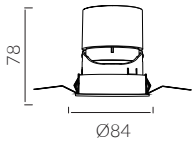

IP Rating:	IP20 and IP44 options
Optics:	5°/10°/24°/36°/50°
UGR:	<10
CRI:	98Ra
Lifetime:	>50,000 hrs (L70 B10)
CCT:	2700K/3000K/3500K/4000K/5000K/ 2000K-3000K/1800K-4000K/2700K-6000K
Typical Source	
Efficacy (lm/W):	110
Control:	On/off, Mains Dim, 0/1-10V, DALI, Zigbee, Casambi
Binning:	2 Step MacAdams
Input:	AC220-240V 50/60Hz
Output:	DC 3V 650mA 3W DC 36V 200mA 8W DC 36V 250mA 10W
Ambient temp:	-20 °C to 45 °C
Class:	II
Optional accessories:	Honeycomb louvre, Solite Lense, Spread Lense, Colour Filter

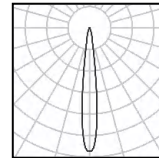

10W Ra98 3000K 10°

h(m)	E(lx)	D(m)
0.5	15902	0.09
1.0	3975	0.17
1.5	1767	0.26
2.0	994	0.34
2.5	636	0.43
3.0	442	0.51

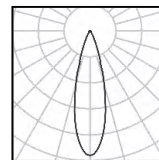

10W Ra98 3000K 24°

h(m)	E(lx)	D(m)
0.5	6416	0.20
1.0	1604	0.39
1.5	713	0.59
2.0	401	0.78
2.5	257	0.98
3.0	178	1.18

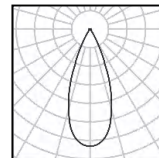

10W Ra98 3000K 36°

h(m)	E(lx)	D(m)
0.5	3888	0.29
1.0	972	0.59
1.5	432	0.88
2.0	243	1.18
2.5	156	1.47
3.0	108	1.77

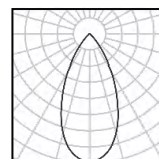

10W Ra98 3000K 50°

h(m)	E(lx)	D(m)
0.5	1540	0.46
1.0	385	0.92
1.5	171	1.39
2.0	96	1.85
2.5	62	2.31
3.0	43	2.77



DuraGreen project:
Alacarte Halong Bay Condotel



W system	lm system	optics	code
3W	152	5°	AFL7503W/S-30N05-W



W system	lm system	optics	code
8W	415	10°	AFL7508W/S-30N10-W
8W	535	15°	AFL7508W/S-30N15-W
8W	598	24°	AFL7508W/S-30N24-W
8W	632	36°	AFL7508W/S-30N36-W
8W	573	50°	AFL7508W/S-30N50-W



W system	lm system	optics	code
10W	450	10°	AFL7510W/S-30N10-W
10W	590	15°	AFL7510W/S-30N15-W
10W	618	24°	AFL7510W/S-30N24-W
10W	699	36°	AFL7510W/S-30N36-W
10W	650	50°	AFL7510W/S-30N50-W

FLOW

FLOW range of linear recessed downlights is designed for seamless integration into any space, offering both visual delight and efficient lighting.



DuraGreen project:
Versace Showroom

FLOW

Recessed 3 Spots Linear



view on website



cutout: 118*48mm



Fixed

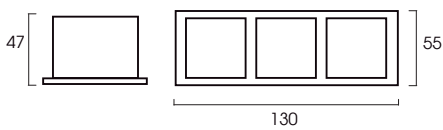

White Painted



Black Painted

- IP Rating:** IP20 and IP44 options
- Optics:** 12°/24°/38°/50°/Wall Wash
- UGR:** <10
- CRI:** 92Ra
- Lifetime:** >50,000 hrs (L70 B10)
- CCT:** 3000K
- Typical Source Efficacy (lm/W):** 113
- Control:** On/off, Mains Dim, 0/1-10V, Dali, Zigbee, Casambi
- Binning:** 2 Step MacAdams
- Input:** AC220-240V 50/60Hz
- Output:** DC 36V 200mA 8W
DC 36V 250mA 10W
- Ambient temp:** -20 °C to 45 °C
- Class:** II

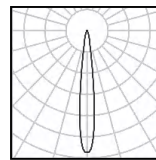

10W Ra92 3000K 12°

h(m)	E(lx)	D(m)
0.5	11477	0.13
1.0	2869	0.27
1.5	1275	0.40
2.0	717	0.53
2.5	459	0.67
3.0	319	0.80

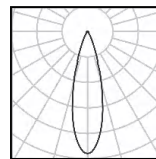

10W Ra92 3000K 24°

h(m)	E(lx)	D(m)
0.5	7647	0.16
1.0	1912	0.33
1.5	850	0.49
2.0	478	0.66
2.5	306	0.82
3.0	212	0.98

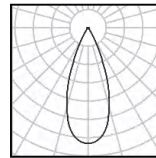

10W Ra92 3000K 38°

h(m)	E(lx)	D(m)
0.5	5017	0.25
1.0	1254	0.50
1.5	557	0.75
2.0	314	1.00
2.5	201	1.26
3.0	139	1.51

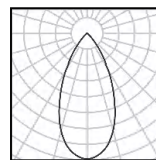

10W Ra92 3000K 50°

h(m)	E(lx)	D(m)
0.5	2771	0.43
1.0	693	0.87
1.5	308	1.30
2.0	173	1.73
2.5	111	2.16
3.0	77	2.60



DuraGreen project:
Yue Kai Entertainment Office



W system	lm system	optics	code
8W	707	12°	FFL0308W-30N12-B
8W	729	24°	FFL0308W-30N24-B
8W	703	38°	FFL0308W-30N38-B
8W	696	50°	FFL0308W-30N50-B



W system	lm system	optics	code
10W	869	12°	FFL0310W-30N12-B
10W	891	24°	FFL0310W-30N24-B
10W	868	38°	FFL0310W-30N38-B
10W	861	50°	FFL0310W-30N50-B

FLOW

Recessed 6 Spots Linear



view on website



cutout :235*48mm



Fixed

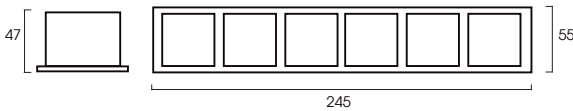

White Painted



Black Painted



- IP Rating:** IP20 and IP44 options
- Optics:** 12°/24°/38°/50°/Wall Wash
- UGR:** < 10
- CRI:** 92Ra
- Lifetime:** >50,000 hrs (L70 B10)
- CCT:** 3000K
- Typical Source Efficacy (lm/W):** 113
- Control:** On/off, Mains Dim, 0/1-10V, Dali, Zigbee, Casambi
- Binning:** 2 Step MacAdams
- Input:** AC220-240V 50/60Hz
- Output:** DC 36V 300mA 12W
DC 36V 350mA 15W
- Ambient temp:** -20 °C to 45 °C
- Class:** II

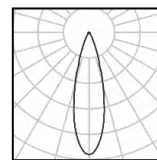

15W Ra92 3000K 24°

h(m)	E(lx)	D(m)
0.5	9378	0.21
1.0	2344	0.43
1.5	1042	0.64
2.0	586	0.86
2.5	375	1.07
3.0	260	1.29

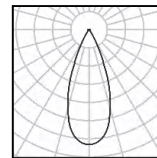

15W Ra92 3000K 38°

h(m)	E(lx)	D(m)
0.5	5017	0.33
1.0	1254	0.67
1.5	557	1.00
2.0	314	1.34
2.5	201	1.67
3.0	139	2.01

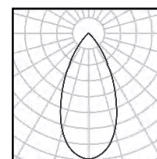

15W Ra92 3000K 50°

h(m)	E(lx)	D(m)
0.5	3325	0.50
1.0	831	1.00
1.5	369	1.50
2.0	208	1.99
2.5	133	2.49
3.0	92	2.99



DuraGreen project:
LONGINES Showroom



W system	lm system	optics	code
12W	1075	12°	FFL0612W-30N12-B
12W	1059	24°	FFL0612W-30N24-B
12W	968	38°	FFL0612W-30N38-B
12W	1066	50°	FFL0612W-30N50-B



W system	lm system	optics	code
15W	1187	12°	FFL0615W-30N12-B
15W	1241	24°	FFL0615W-30N24-B
15W	1266	38°	FFL0615W-30N38-B
15W	1220	50°	FFL0615W-30N50-B

FLOW

Recessed 9 Spots Linear



view on website



cutout :350*48mm



Fixed

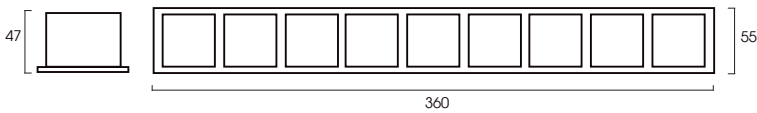

White Painted



Black Painted



- IP Rating:** IP20 and IP44 options
- Optics:** 12°/24°/38°/50°/Wall Wash
- UGR:** < 10
- CRI:** 92Ra
- Lifetime:** >50,000 hrs (L70 B10)
- CCT:** 3000K
- Typical Source Efficacy (lm/W):** 113
- Control:** On/off, Mains Dim, 0/1-10V, Dali, Zigbee, Casambi
- Binning:** 2 Step MacAdams
- Input:** AC220-240V 50/60Hz
- Output:** DC 36V 500mA 20W
DC 36V 600mA 25W
- Ambient temp:** -20 °C to 45 °C
- Class:** II

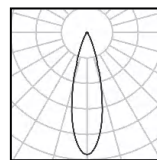

25W Ra92 3000K 24°

h(m)	E(lx)	D(m)
0.5	12084	0.25
1.0	3021	0.50
1.5	1343	0.75
2.0	755	1.00
2.5	483	1.25
3.0	336	1.50

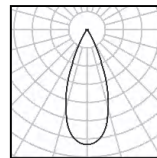

25W Ra92 3000K 38°

h(m)	E(lx)	D(m)
0.5	10063	0.31
1.0	2516	0.61
1.5	1118	0.92
2.0	629	1.22
2.5	403	1.53
3.0	280	1.83

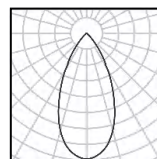

25W Ra92 3000K 50°

h(m)	E(lx)	D(m)
0.5	5483	0.46
1.0	1371	0.92
1.5	609	1.38
2.0	343	1.84
2.5	219	2.30
3.0	152	2.76



W system	lm system	optics	code
20W	1636	12°	FFL0920W-30N12-B
20W	1656	24°	FFL0920W-30N24-B
20W	1584	38°	FFL0920W-30N38-B
20W	1672	50°	FFL0920W-30N50-B



W system	lm system	optics	code
25W	1889	12°	FFL0925W-30N12-B
25W	1883	24°	FFL0925W-30N24-B
25W	1917	38°	FFL0925W-30N38-B
25W	1842	50°	FFL0925W-30N50-B

FLOW

Recessed 15 Spots Linear



[view on website](#)



cutout :580*48mm



Fixed



White Painted



Black Painted

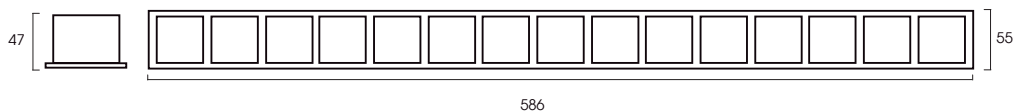

IP Rating:	IP20 and IP44 options
Optics:	12°/24°/38°/50°/Wall Wash
UGR:	<10
CRI:	92Ra
Lifetime:	>50,000 hrs (L70 B10)
CCT:	3000K/RGB
Typical Source Efficacy (lm/W):	113
Control:	On/off, Mains Dim, 0/1-10V, Dali, Zigbee, Casambi
Binning	2 Step MacAdams
Input:	AC220-240V 50/60Hz
Output:	DC 24V 6W
Ambient temp:	-20 °C to 45 °C
Class:	II



DuraGreen project:
Private Residence



W system	lm system	optics	code
6W	518	12°	FFL1524V06W-30N12-B
6W	542	24°	FFL1524V06W-30N24-B
6W	570	38°	FFL1524V06W-30N38-B
6W	556	50°	FFL1524V06W-30N50-B

FLOW

Recessed 30 Spots Linear



cutout: 1150*48mm



Fixed



White Painted



Black Painted

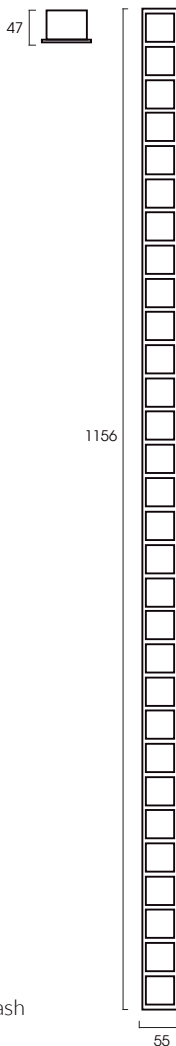

[view on website](#)

IP Rating:	IP20 and IP44 options
Optics:	12°/24°/38°/50°/Wall Wash
UGR:	<10
CRI:	92Ra
Lifetime:	>50,000 hrs (L70 B10)
CCT:	3000K/RGB
Typical Source Efficacy (lm/W):	113
Control:	On/off, Mains Dim, 0/1-10V, Dali, Zigbee, Casambi
Binning	2 Step MacAdams
Input:	AC220-240V 50/60Hz
Output:	DC 24V 12W
Ambient temp:	-20 °C to 45 °C
Class:	II



DuraGreen project:
Versace Showroom



W system	lm system	optics	code
12W	1036	12°	FFL3024V12W-30N12-B
12W	1088	24°	FFL3024V12W-30N24-B
12W	1143	38°	FFL3024V12W-30N38-B
12W	1117	50°	FFL3024V12W-30N50-B

RING

Recessed Light Circle

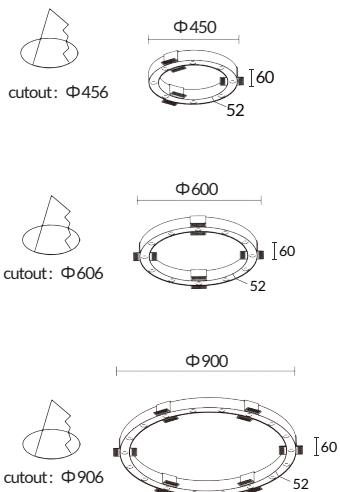

Repair disk



Black Painted

IP Rating:	IP20
Optics:	24°
UGR:	<10
CRI:	92Ra
Lifetime:	>50,000 hrs (L70 B10)
CCT:	3000K
Typical Source	
Efficacy (lm/W):	103
Control:	On/off, Mains Dim, 0/1-10V, Dali, Zigbee, Casambi
Binning	2 Step MacAdams
Input:	AC220-240V 50/60Hz
Output:	DC27V 700mA 21W DC36V 700mA 28W DC54V 700mA 42W
Ambient temp:	-20 °C to 45 °C
Class:	II



DuraGreen project:
DuraGreen Distributor Showroom



W system	lm system	optics	cutout	code
21W	1050	24°	450mm	LCR45021W



W system	lm system	optics	cutout	code
28W	1400	24°	600mm	LCR60028W



W system	lm system	optics	cutout	code
42W	2100	24°	900mm	LCR90042W

CUPOLA





DuraGreen project:
Schüller Showroom

CUPOLA STAR

Φ35 Adjustable Round



cutout:35mm



Adjustable Optic

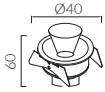

view on website



True non-intrusive-in lighting solutions to
integrate lighting with architecture

IP Rating:	IP20
Optics:	20°
UGR:	<10
CRI:	92Ra
Lifetime:	>50,000 hrs (L70 B10)
CCT:	2700K/3000K
Typical Source	
Efficacy (lm/W):	103
Control:	On/off, Mains Dim, 0/1-10V, Dali, Zigbee, Casambi
Binning	2 Step MacAdams
Input:	AC220-240V 50/60Hz
Output:	DC 3V 300mA 1.3W
Ambient temp:	-20 °C to 45 °C
Class:	II



DuraGreen project:
Schüller Showroom



W system	lm system	optics	code
1.3W	82	20°	AFS351.3W-30NL20-B

CUPOLA ZOOM

Φ75 Adjustable Round



view on website



cutout :75mm



Adjustable Optic

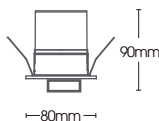
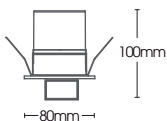

360° Movability



Choose your light

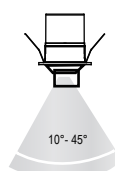

ZOOM

- IP Rating:** IP20 and IP44 options
- Optics:** 10°-45°
- UGR:** < 10
- CRI:** 92Ra with 98Ra option
- Lifetime:** >50,000 hrs (L70 B10)
- CCT:** 2700K/3000K/3500K/4000K/5000K
- Typical Source**
- Efficacy (lm/W):** 133
- Control:** On/off, Mains Dim, 0/1-10V, Dali, Zigbee, Casambi
- Binning** 2 Step MacAdams
- Input:** AC220-240V 50/60Hz
- Output:** DC 36V 150mA 6W
DC 36V 200mA 8W
DC 36V 250mA 10W
DC 36V 300mA 12W
- Ambient temp:** -20 °C to 45 °C
- Class:** II

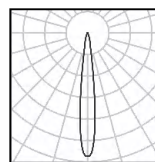

10W Ra92 3000K 15°

h(m)	E(lx)	D(m)
0.5	6134	0.14
1.0	1533	0.28
1.5	682	0.42
2.0	383	0.56
2.5	245	0.70
3.0	170	0.84

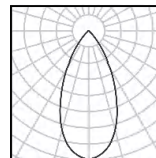

10W Ra92 3000K 45°

h(m)	E(lx)	D(m)
0.5	793	0.50
1.0	198	1.00
1.5	88	1.50
2.0	50	2.00
2.5	32	2.50
3.0	22	3.00



DuraGreen project:
SOK Steak house



W system	lm system	optics	code
6W	520	10°- 45°	AFZ7506W-30N1045-W



W system	lm system	optics	code
8W	668	10°- 45°	AFZ7508W-30N1045-W



W system	lm system	optics	code
10W	970	10°- 45°	AFZ7510W-30N1045-W



W system	lm system	optics	code
12W	1029	10°- 45°	AFZ7512W-30N1045-W

ACME SPY

Designed with ease and convenience in mind, these fixtures feature a user-friendly pull mechanism that enables your favorite pieces, artwork, or decor to be highlighted. From sculptures to paintings, let ACME SPY bring your treasures to life with precise, targeted radiance, adding both function and form to your stylish space.



DuraGreen project:
AXENT Showroom

ACME SPY

Φ50 In/out Spotlights





cutout: 50mm



Adjustable Optic



 matt white painted

 matt black painted



Recessed Trim

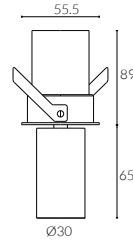

view on website



Recessed Trimless

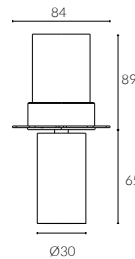

view on website

IP Rating:	IP20 and IP44 options
Optics:	15°/28°/36°
UGR:	< 10
CRI:	98Ra
Lifetime:	>50,000 hrs (L70 B10)
CCT:	2700K/3000K/3500K/4000K/5000K/ 2000K-3000K/1800K-4000K/2700K-6000K

Typical Source	
Efficacy (lm/W):	110
Control:	On/off, Mains Dim, 0/1-10V, Dali, Zigbee, Casambi
Binning	2 Step MacAdams
Input:	AC220-240V 50/60Hz
Output:	DC 36V 150mA 6W
Ambient temp:	-20 °C to 45 °C
Class:	II
Material:	Fine aluminium 6063A

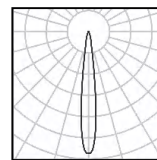

6W Ra98 3000K 15°

h(m)	E(lx)	D(m)
0.5	4937	0.14
1.0	1234	0.27
1.5	549	0.41
2.0	309	0.54
2.5	197	0.68
3.0	137	0.81

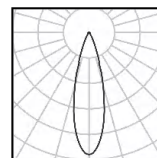

6W Ra98 3000K 28°

h(m)	E(lx)	D(m)
0.5	2848	0.25
1.0	712	0.49
1.5	316	0.74
2.0	178	0.98
2.5	114	1.23
3.0	79	1.47

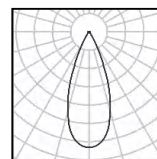

6W Ra98 3000K 36°

h(m)	E(lx)	D(m)
0.5	1706	0.31
1.0	426	0.62
1.5	190	0.93
2.0	107	1.25
2.5	68	1.56
3.0	47	1.87



DuraGreen project:
Stellar Works Flagship Showroom



Recessed Trim

W system	lm system	optics	code
6W	373	15°	AFL5006W-IO-30N15-B
6W	445	28°	AFL5006W-IO-30N28-B
6W	446	36°	AFL5006W-IO-30N36-B



Recessed Trimless

W system	lm system	optics	code
6W	373	15°	AFL5006W-IO-TL-30N15-B
6W	445	28°	AFL5006W-IO-TL-30N28-B
6W	446	36°	AFL5006W-IO-TL-30N36-B

ACME SPY

Φ57 In/out Spotlights





cutout: 57mm



Adjustable Optic



 matt white painted

 matt black painted



Recessed Trim

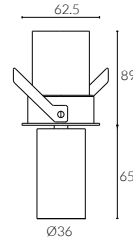

view on website



Recessed Trimless

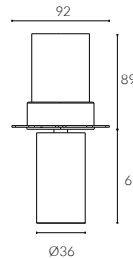

view on website

IP Rating:	IP20 and IP44 options
Optics:	15°/24°/36°
UGR:	< 10
CRI:	98Ra
Lifetime:	>50,000 hrs (L70 B10)
CCT:	2700K/3000K/3500K/4000K/5000K/ 2000K-3000K/1800K-4000K/2700K-6000K

Typical Source

Efficacy (lm/W):	110
Control:	On/off, Mains Dim, 0/1-10V, Dali, Zigbee, Casambi
Binning	2 Step MacAdams
Input:	AC220-240V 50/60Hz
Output:	DC 36V 200mA 8W
Ambient temp:	-20 °C to 45 °C
Class:	II
Material:	Fine aluminium 6063A

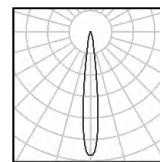

8W Ra98 3000K 15°

h(m)	E(lx)	D(m)
0.5	7550	0.11
1.0	1888	0.22
1.5	839	0.34
2.0	472	0.45
2.5	302	0.56
3.0	210	0.67

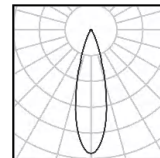

8W Ra98 3000K 24°

h(m)	E(lx)	D(m)
0.5	2868	0.24
1.0	717	0.49
1.5	319	0.73
2.0	179	0.98
2.5	115	1.22
3.0	80	1.46

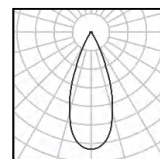

8W Ra98 3000K 36°

h(m)	E(lx)	D(m)
0.5	2108	0.36
1.0	527	0.72
1.5	234	1.08
2.0	132	1.44
2.5	84	1.80
3.0	59	2.16



DuraGreen project:
CO | Michelin Stared Restaurant



W system	lm system	optics	code
8W	328	15°	AFL5708W-IO-30N15-B
8W	404	24°	AFL5708W-IO-30N24-B
8W	499	36°	AFL5708W-IO-30N36-B



W system	lm system	optics	code
8W	328	15°	AFL5708W-IO-TL-30N15-B
8W	404	24°	AFL5708W-IO-TL-30N24-B
8W	499	36°	AFL5708W-IO-TL-30N36-B

ACME SPY

Φ68 In/out Spotlights



cutout: 68mm



Adjustable Optic

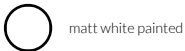

matt white painted



matt black painted



Recessed Trim

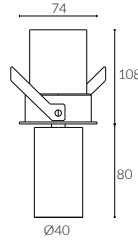

view on website



Recessed Trimless

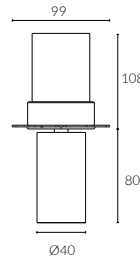

view on website

- IP Rating:** IP20 and IP44 options
- Optics:** 15°/24°/36°/50°
- UGR:** < 10
- CRI:** 98Ra
- Lifetime:** >50,000 hrs (L70 B10)
- CCT:** 2700K/3000K/3500K/4000K/5000K/
2000K-3000K/1800K-4000K/2700K-6000K

Typical Source

- Efficacy (lm/W):** 110
- Control:** On/off, Mains Dim, 0/1-10V, Dali, Zigbee, Casambi
- Binning** 2 Step MacAdams
- Input:** AC220-240V 50/60Hz
- Output:** DC 36V 250mA 10W
- Ambient temp:** -20 °C to 45 °C
- Class:** II
- Material:** Fine aluminium 6063A

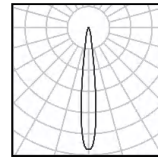

10W Ra98 3000K 15°

h(m)	E(lx)	D(m)
0.5	8822	0.15
1.0	2206	0.30
1.5	980	0.45
2.0	551	0.60
2.5	353	0.76
3.0	245	0.91

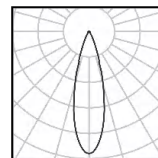

10W Ra98 3000K 24°

h(m)	E(lx)	D(m)
0.5	6615	0.23
1.0	1654	0.46
1.5	735	0.69
2.0	413	0.92
2.5	265	1.15
3.0	184	1.37

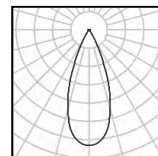

10W Ra98 3000K 36°

h(m)	E(lx)	D(m)
0.5	3458	0.32
1.0	864	0.65
1.5	384	0.97
2.0	216	1.29
2.5	138	1.61
3.0	96	1.94

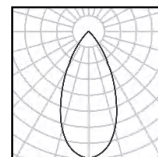

10W Ra98 3000K 50°

h(m)	E(lx)	D(m)
0.5	2048	0.45
1.0	512	0.89
1.5	228	1.34
2.0	128	1.79
2.5	82	2.24
3.0	57	2.68



DuraGreen project:
London Luxury Home



W system	lm system	optics	code
10W	501	15°	AFL6810W-IO-30N15-B
10W	653	24°	AFL6810W-IO-30N24-B
10W	692	36°	AFL6810W-IO-30N36-B
10W	676	50°	AFL6810W-IO-30N50-B



W system	lm system	optics	code
10W	501	15°	AFL6810W-IO-TL-30N15-B
10W	653	24°	AFL6810W-IO-TL-30N24-B
10W	692	36°	AFL6810W-IO-TL-30N36-B
10W	676	50°	AFL6810W-IO-TL-30N50-B

ACME SPY

Φ78 In/out Spotlights



Recessed Trim

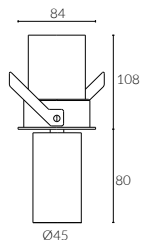

view on website



Recessed Trimless

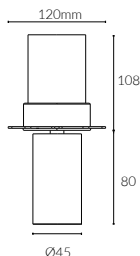

view on website

- IP Rating:** IP20 and IP44 options
- Optics:** 15°/24°/36°/50°
- UGR:** < 10
- CRI:** 98Ra
- Lifetime:** >50,000 hrs (L70 B10)
- CCT:** 2700K/3000K/3500K/4000K/5000K/
2000K-3000K/1800K-4000K/2700K-6000K

Typical Source

- Efficacy (lm/W):** 110
- Control:** On/off, Mains Dim, 0/1-10V, Dali, Zigbee, Casambi
- Binning** 2 Step MacAdams
- Input:** AC220-240V 50/60Hz
- Output:** DC 36V 250mA 10W
- Ambient temp:** -20 °C to 45 °C
- Class:** II
- Material:** Fine aluminium 6063A

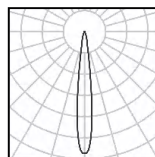

10W Ra98 3000K 15°

h(m)	E(lx)	D(m)
0.5	8822	0.15
1.0	2206	0.30
1.5	980	0.45
2.0	551	0.60
2.5	353	0.76
3.0	245	0.91

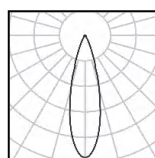

10W Ra98 3000K 24°

h(m)	E(lx)	D(m)
0.5	6615	0.23
1.0	1654	0.46
1.5	735	0.69
2.0	413	0.92
2.5	265	1.15
3.0	184	1.37

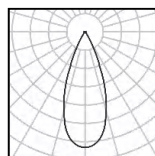

10W Ra98 3000K 36°

h(m)	E(lx)	D(m)
0.5	3458	0.32
1.0	864	0.65
1.5	384	0.97
2.0	216	1.29
2.5	138	1.61
3.0	96	1.94

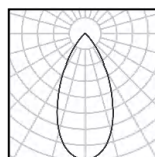

10W Ra98 3000K 50°

h(m)	E(lx)	D(m)
0.5	2048	0.45
1.0	512	0.89
1.5	228	1.34
2.0	128	1.79
2.5	82	2.24
3.0	57	2.68



DuraGreen project:
MESTRE Showroom



W system	lm system	optics	code
10W	501	15°	AFL7810W-IO-30N15-B
10W	653	24°	AFL7810W-IO-30N24-B
10W	692	36°	AFL7810W-IO-30N36-B
10W	676	50°	AFL7810W-IO-30N50-B



W system	lm system	optics	code
10W	501	15°	AFL7810W-IO-TL-30N15-B
10W	653	24°	AFL7810W-IO-TL-30N24-B
10W	692	36°	AFL7810W-IO-TL-30N36-B
10W	676	50°	AFL7810W-IO-TL-30N50-B

ACME SPY



Φ78 Short Snoot Downlight



cutout: 78mm



Recessed Trim

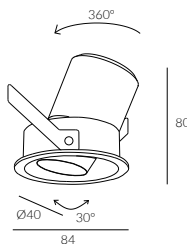

view on website



Adjustable Optic



Recessed Trimless

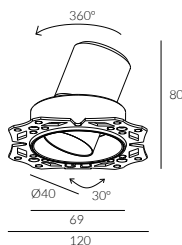

view on website

Structure



Black Painted
9005



White Painted
9016



Solid Brass



Antique Bronze



Black Nickel



Brushed Grey



Polished Chrome

- IP Rating:** IP20 and IP44 options
- Optics:** 10°/15°/24°/36°/42°
- UGR:** < 10
- CRI:** 98Ra
- Lifetime:** > 50,000 hrs (L70 B10)
- CCT:** 2700K/3000K/3500K/4000K/5000K/
2000K-3000K/1800K-4000K/2700K-6000K

Typical Source

- Efficacy (lm/W):** 110
- Control:** On/off, Mains Dim, 0/1-10V, Dali, Zigbee, Casambi
- Binning:** 2 Step MacAdams
- Input:** AC220-240V 50/60Hz
- Output:** DC 36V 250mA 10W
- Ambient temp:** -20 °C to 45 °C
- Class:** II
- Material:** Fine aluminium 6063A

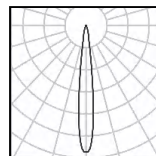

10W Ra98 3000K 10°

h(m)	E(lx)	D(m)
0.5	14091	0.08
1.0	3523	0.17
1.5	1566	0.25
2.0	881	0.34
2.5	564	0.42
3.0	391	0.50

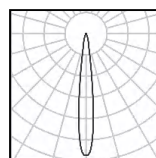

10W Ra98 3000K 15°

h(m)	E(lx)	D(m)
0.5	8307	0.14
1.0	2077	0.28
1.5	923	0.42
2.0	519	0.56
2.5	332	0.70
3.0	231	0.84

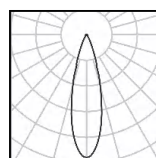

10W Ra98 3000K 24°

h(m)	E(lx)	D(m)
0.5	4933	0.19
1.0	1233	0.39
1.5	548	0.58
2.0	308	0.78
2.5	197	0.97
3.0	137	1.17

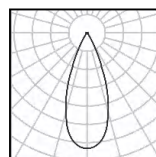

10W Ra98 3000K 36°

h(m)	E(lx)	D(m)
0.5	2734	0.31
1.0	684	0.63
1.5	304	0.94
2.0	171	1.25
2.5	109	1.57
3.0	76	1.88

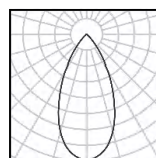

10W Ra98 3000K 42°

h(m)	E(lx)	D(m)
0.5	1561	0.38
1.0	390	0.77
1.5	173	1.15
2.0	98	1.54
2.5	62	1.92
3.0	43	2.30

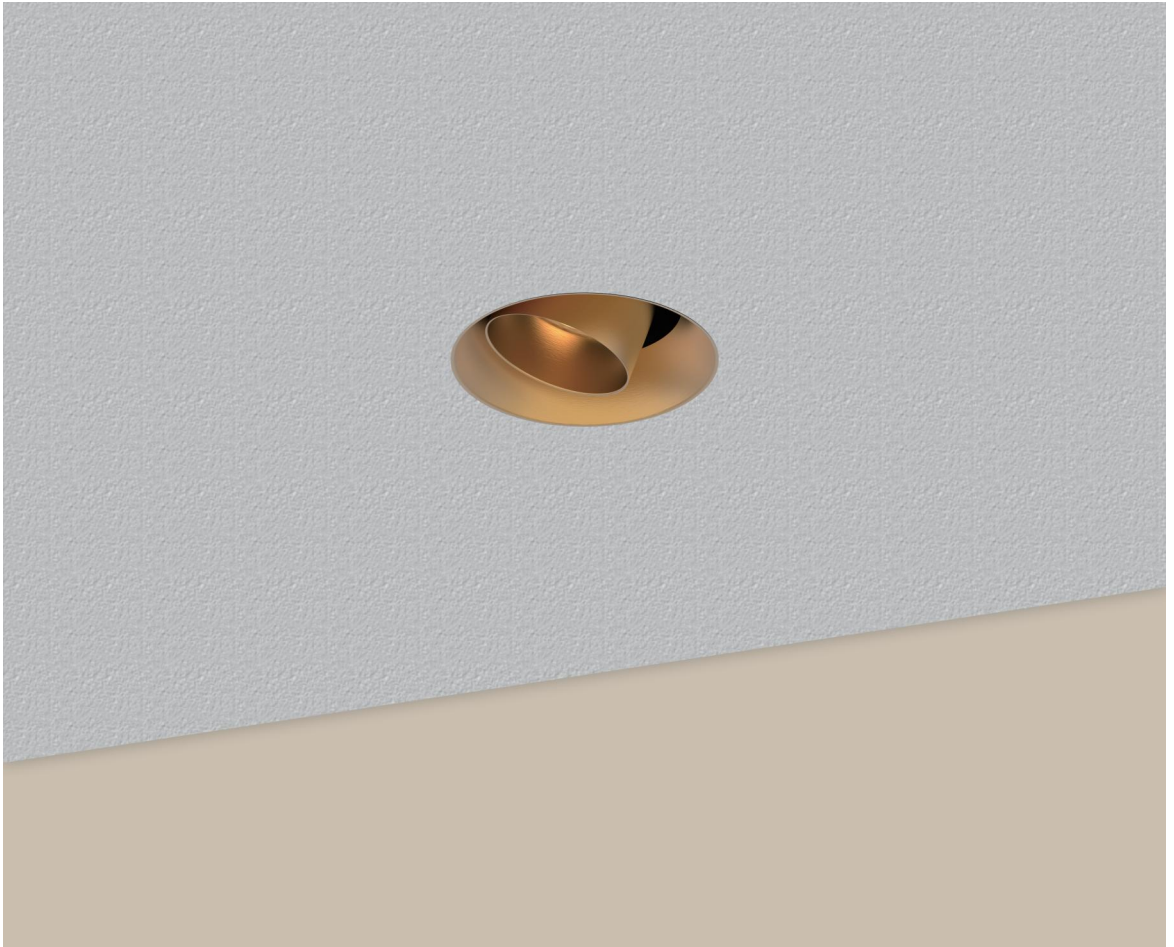

W system	lm system	optics	code
10W	490	10°	AFL7810W-SS-30N10-SB
10W	553	15°	AFL7810W-SS-30N15-SB
10W	540	24°	AFL7810W-SS-30N24-SB
10W	664	36°	AFL7810W-SS-30N36-SB
10W	556	42°	AFL7810W-SS-30N42-SB



W system	lm system	optics	code
10W	490	10°	AFL7810W-SS-TL-30N10-SB
10W	553	15°	AFL7810W-SS-TL-30N15-SB
10W	540	24°	AFL7810W-SS-TL-30N24-SB
10W	664	36°	AFL7810W-SS-TL-30N36-SB
10W	556	42°	AFL7810W-SS-TL-30N42-SB

ACME SPY



Φ78 Long Snout Downlight



cutout:78mm



Adjustable Optic



Structure



Black Painted 9005

White Painted 9016



Solid Brass

Antique Bronze



Black Nickel

Brushed Grey



Polished Chrome

- IP Rating:** IP20 and IP44 options
- Optics:** 10°/15°/24°/36°/42°
- UGR:** <10
- CRI:** 98Ra
- Lifetime:** >50,000 hrs (L70 B10)
- CCT:** 2700K/3000K/3500K/4000K/5000K/
2000K-3000K/1800K-4000K/2700K-6000K

Typical Source

- Efficacy (lm/W):** 110
- Control:** On/off, Mains Dim, 0/1-10V, Dali, Zigbee, Casambi
- Binning:** 2 Step MacAdams
- Input:** AC220-240V 50/60Hz
- Output:** DC 36V 250mA 10W
- Ambient temp:** -20 C to 45 C
- Class:** II
- Material:** Fine aluminium 6063A

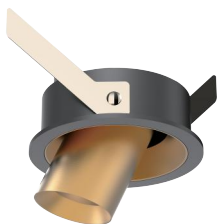

Recessed Trim

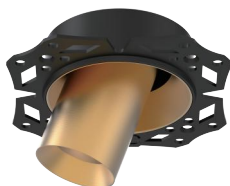
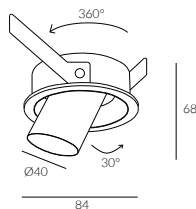

Recessed Trimless

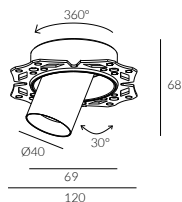

view on website



view on website

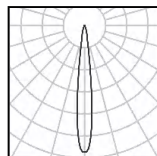

10W Ra98 3000K 10°

h(m)	E(lx)	D(m)
0.5	14091	0.08
1.0	3523	0.17
1.5	1566	0.25
2.0	881	0.34
2.5	564	0.42
3.0	391	0.50

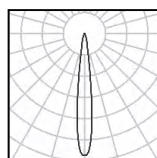

10W Ra98 3000K 15°

h(m)	E(lx)	D(m)
0.5	8307	0.14
1.0	2077	0.28
1.5	923	0.42
2.0	519	0.56
2.5	332	0.70
3.0	231	0.84

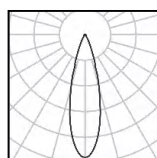

10W Ra98 3000K 24°

h(m)	E(lx)	D(m)
0.5	4933	0.19
1.0	1233	0.39
1.5	548	0.58
2.0	308	0.78
2.5	197	0.97
3.0	137	1.17

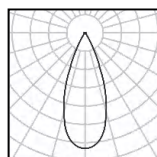

10W Ra98 3000K 36°

h(m)	E(lx)	D(m)
0.5	2734	0.31
1.0	684	0.63
1.5	304	0.94
2.0	171	1.25
2.5	109	1.57
3.0	76	1.88

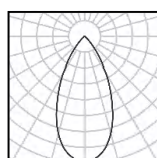

10W Ra98 3000K 42°

h(m)	E(lx)	D(m)
0.5	1561	0.38
1.0	390	0.77
1.5	173	1.15
2.0	98	1.54
2.5	62	1.92
3.0	43	2.30

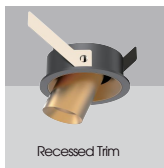

Recessed Trim

W system	lm system	optics	code
10W	490	10°	AFL7810W-LS-30N10-B
10W	553	15°	AFL7810W-LS-30N15-B
10W	540	24°	AFL7810W-LS-30N24-B
10W	664	36°	AFL7810W-LS-30N36-B
10W	556	42°	AFL7810W-LS-30N42-B



Recessed Trimless

W system	lm system	optics	code
10W	490	10°	AFL7810W-LS-TL-30N10-B
10W	553	15°	AFL7810W-LS-TL-30N15-B
10W	540	24°	AFL7810W-LS-TL-30N24-B
10W	664	36°	AFL7810W-LS-TL-30N36-B
10W	556	42°	AFL7810W-LS-TL-30N42-B

BELLA

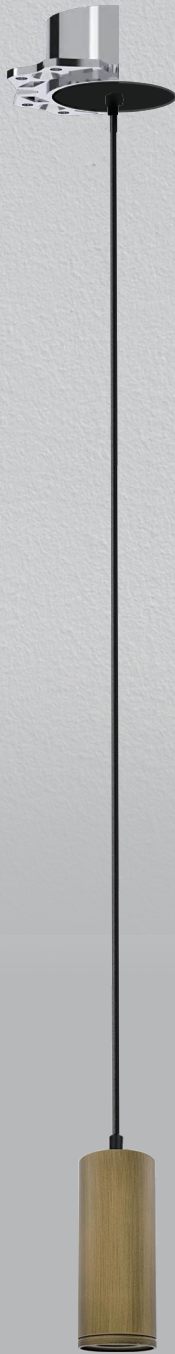

Enjoy limitless possibilities with our 36 mm cutout plaster-in ring for downlights, zoomable spotlights, and pendants.

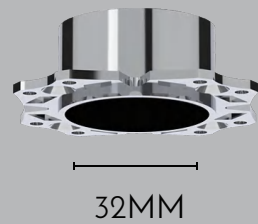

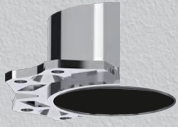

Immerse yourself in the versatility of our beam angle adjustable light, providing a zoomable range of 20 to 50 degrees with a simple twist of the front ring. Whether you desire focused lighting for a table or a gentle, ambient glow for premium residential or commercial interiors, this innovative fixture effortlessly caters to your lighting needs. Experience the perfect balance of functionality and style as you create the ideal atmosphere.

Φ41 Recessed Zoomable 20°-50° Spotlight



Adjustable Optic



Recessed Trim

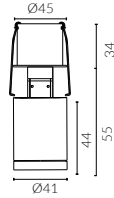

cutout: 40mm



[view on website](#)



White Painted



Black Painted



Antique Bronze



Brushed Grey



Recessed Trimless

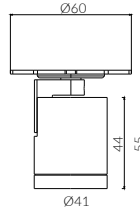

cutout: 36mm



[view on website](#)

- IP Rating:** IP20
- Optics:** Zoomable 20°-50°
- UGR:** <17
- CRI:** 92Ra
- Lifetime:** >50,000 hrs (L70 B10)
- CCT:** 3000K/3500K/2700-6000K
- Typical Source Efficacy (lm/W):** 96
- Control:** On/off, Mains Dim, 0/1-10V, Dali, Zigbee, Casambi
- Binning:** 2 Step MacAdams
- Input:** AC220-240V 50/60Hz
- Output:** DC 12V 350mA 6W
- Ambient temp:** -20 C to 45 C
- Class:** II
- Material:** Fine aluminium 6063A

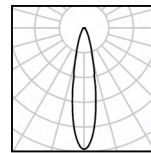

6W Ra92 3000K 20°

h(m)	E lx	D(m)
0.5	2355	0.20
1.0	589	0.40
1.5	262	0.59
2.0	147	0.79
2.5	94	0.99
3.0	65	1.19

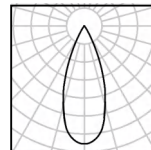

6W Ra92 3000K 30°

h(m)	E lx	D(m)
0.5	1378	0.29
1.0	344	0.58
1.5	153	0.88
2.0	86	1.17
2.5	55	1.46
3.0	38	1.75

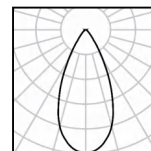

6W Ra92 3000K 50°

h(m)	E lx	D(m)
0.5	616	0.47
1.0	154	0.95
1.5	68	1.42
2.0	38	1.90
2.5	25	2.37
3.0	17	2.85

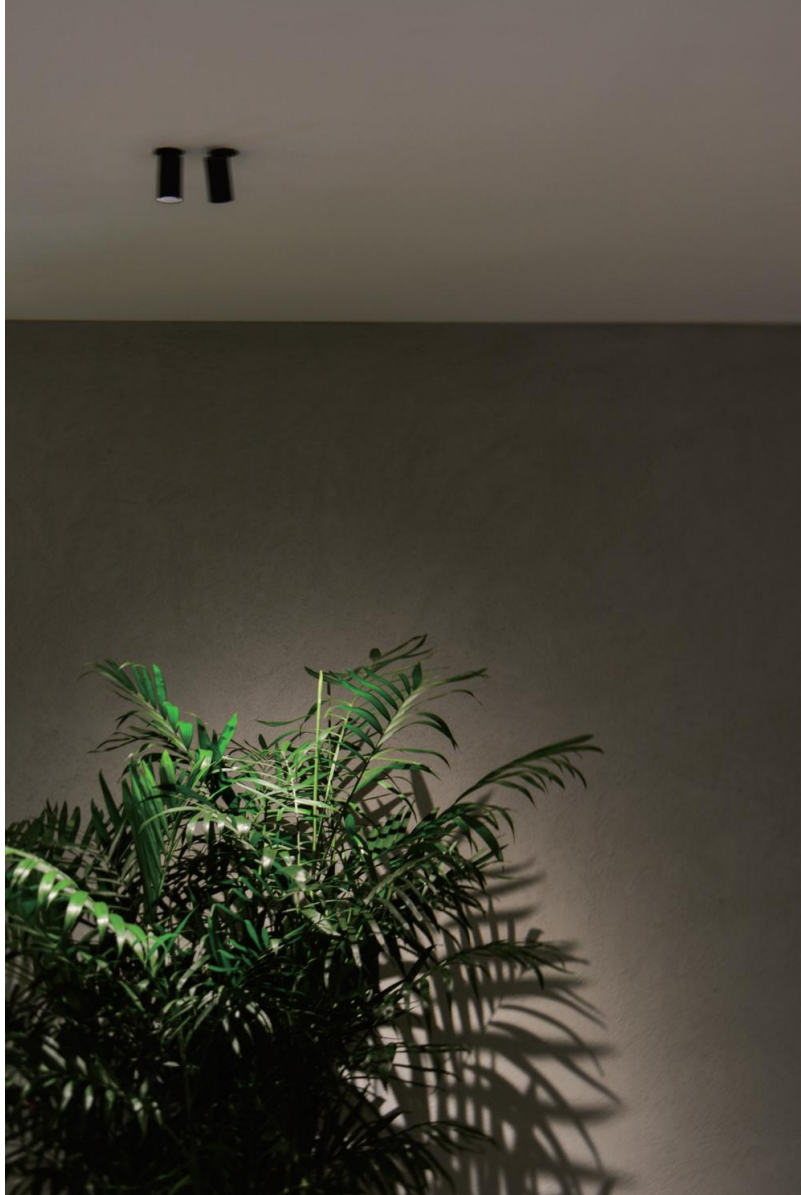

W system	lm system	optics	code
6W	292-296	20°- 50°	RT4106W-30N2050-B



W system	lm system	optics	code
6W	292-296	20°- 50°	TL4106W-30N2050-B

Φ68 Recessed Zoomable 15°-50° Spotlight



Adjustable Optic



Black Painted



Recessed Trim

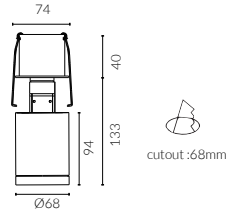

[view on website](#)



Recessed Trimless

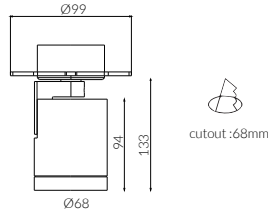

[view on website](#)

- IP Rating:** IP20
- Optics:** Zoomable 15°-50°
- UGR:** <17
- CRI:** 98Ra
- Lifetime:** >50,000 hrs (L70 B10)
- CCT:** 2700K/3000K/3500K/4000K/5000K/
2000K-3000K/1800K-4000K/2700K-6000K

- Typical Source Efficacy (lm/W):** 110
- Control:** On/off, Mains Dim, 0/1-10V, Dali, Zigbee, Casambi
- Binning:** 2 Step MacAdams
- Input:** AC220-240V 50/60Hz
- Output:** DC 36V 300mA 12W
- Ambient temp:** -20 °C to 45 °C
- Class:** II
- Material:** Fine aluminium 6063A

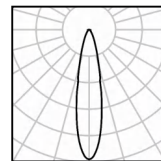

12W Ra98 3000K 15°

h(m)	E(lx)	D(m)
0.5	12099	0.14
1.0	3025	0.27
1.5	1344	0.41
2.0	756	0.54
2.5	484	0.68
3.0	336	0.81

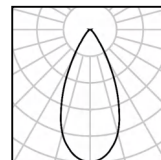

12W Ra98 3000K 40°

h(m)	E(lx)	D(m)
0.5	2174	0.38
1.0	544	0.76
1.5	242	1.14
2.0	136	1.52
2.5	87	1.90
3.0	60	2.28



DuraGreen project:
YELLOWKORNER Art Gallery



Recessed Trim

W system	lm system	optics	code
12W	756-747	15°- 50°	RT6812W-30N1550-B



Recessed Trimless

W system	lm system	optics	code
12W	756-747	15°- 50°	TL6812W-30N1550-B

Φ68 Recessed Contour Spotlight



Adjustable Optic



Recessed Trim

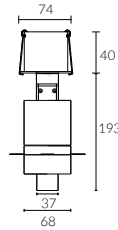

cutout :68mm



view on website



Black Painted



Recessed Trimless

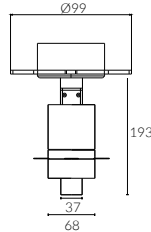

cutout :68mm



view on website

- IP Rating:** IP20
- Optics:** Framing
- UGR:** <10
- CRI:** 92Ra
- Lifetime:** >50,000 hrs (L70 B10)
- CCT:** 2700K/3000K/3500K/4000K/5000K/
2000K-3000K/1800K-4000K/2700K-6000K

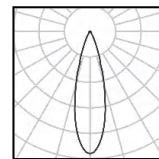

10W Ra98 3000K 24°

h(m)	E(lx)	D(m)
0.5	3216	0.21
1.0	804	0.42
1.5	357	0.63
2.0	201	0.84
2.5	129	1.04
3.0	89	1.25

- Typical Source Efficacy (lm/W):** 113
- Control:** On/off, Mains Dim, 0/1-10V, Dali, Zigbee, Casambi
- Binning:** 2 Step MacAdams
- Input:** AC220-240V 50/60Hz
- Output:** DC 36V 250mA 10W
- Ambient temp:** -20 °C to 45 °C
- Class:** II
- Material:** Fine aluminium 6063A



Recessed Trim

W system	lm system	code
10W	239	RTC6810W



Recessed Trimless

W system	lm system	code
10W	239	TLC6810W

ARTFOCUS

Φ36 Recessed Spotlight



Adjustable Optic



Recessed Trim

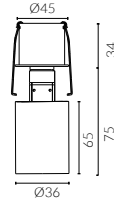

cutout: 40mm



view on website



matt white painted

matt black painted



Recessed Trimless

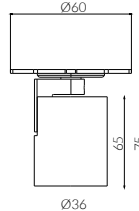

cutout: 36mm



view on website

- IP Rating:** IP20 and IP44 options
- Optics:** 15°/28°/36°
- UGR:** <10
- CRI:** 92Ra
- Lifetime:** >50,000 hrs (L70 B10)
- CCT:** 2700K/3000K/3500K/4000K/5000K/
2000K-3000K/1800K-4000K/2700K-6000K

- Typical Source**
- Efficacy (lm/W):** 133
- Control:** On/off, Mains Dim, 0/1-10V, Dali, Zigbee, Casambi
- Binning** 2 Step MacAdams
- Input:** AC220-240V 50/60Hz
- Output:** DC 36V 150mA 6W
- Ambient temp:** -20 °C to 45 °C
- Class:** II
- Material:** Fine aluminium 6063A

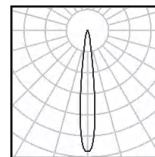

6W Ra98 3000K 15°

h(m)	E(lx)	D(m)
0.5	4937	0.14
1.0	1234	0.27
1.5	549	0.41
2.0	309	0.54
2.5	197	0.68
3.0	137	0.81

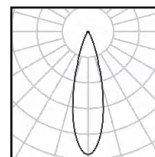

6W Ra98 3000K 28°

h(m)	E(lx)	D(m)
0.5	2848	0.25
1.0	712	0.49
1.5	316	0.74
2.0	178	0.98
2.5	114	1.23
3.0	79	1.47

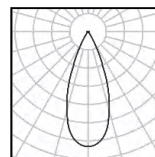

6W Ra98 3000K 36°

h(m)	E(lx)	D(m)
0.5	1706	0.31
1.0	426	0.62
1.5	190	0.93
2.0	107	1.25
2.5	68	1.56
3.0	47	1.87



W system	lm system	optics	code
6W	373	15°	RT3606W-30N15-B
6W	445	28°	RT3606W-30N28-B
6W	446	36°	RT3606W-30N36-B



W system	lm system	optics	code
6W	373	15°	TL3606W-30N15-B
6W	445	28°	TL3606W-30N28-B
6W	446	36°	TL3606W-30N36-B

ORBIT

Φ35 Recessed Adjustable Spotlight



view on website



cutout :58mm



Adjustable Optic

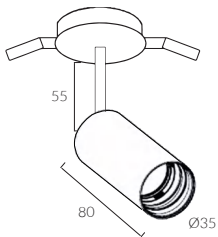

-  White Painted
-  Black Painted

- IP Rating:** IP20 and IP44 options
- Optics:** 15°/30°/40°/55°
- UGR:** < 10
- CRI:** 98Ra
- Lifetime:** >50,000 hrs (L70 B10)
- CCT:** 2700K/3000K
- Typical Source**
- Efficacy (lm/W):** 110
- Control:** On/off, Mains Dim, 0/1-10V, Dali, Zigbee, Casambi
- Binning:** 2 Step MacAdams
- Input:** AC220-240V 50/60Hz
- Output:** DC 36V 150mA 6W
- Ambient temp:** -20 °C to 45 °C
- Class:** II
- Optional accessories:** Honeycomb louvre, Solite Lens, Spread Lens, Colour Filter

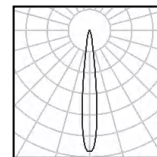

6W Ra98 3000K 15°

h(m)	E(lx)	D(m)
0.5	4391	0.14
1.0	1098	0.27
1.5	488	0.41
2.0	274	0.55
2.5	176	0.68
3.0	122	0.82

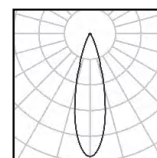

6W Ra98 3000K 30°

h(m)	E(lx)	D(m)
0.5	2085	0.28
1.0	521	0.55
1.5	232	0.83
2.0	130	1.10
2.5	83	1.38
3.0	58	1.65

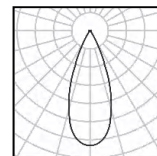

6W Ra98 3000K 40°

h(m)	E(lx)	D(m)
0.5	1572	0.38
1.0	393	0.76
1.5	175	1.15
2.0	98	1.53
2.5	63	1.91
3.0	44	2.29

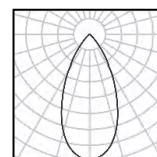

6W Ra98 3000K 55°

h(m)	E(lx)	D(m)
0.5	707	0.53
1.0	177	1.07
1.5	79	1.60
2.0	44	2.14
2.5	28	2.67
3.0	20	3.20



W system	lm system	optics	code
6W	267	15°	MAR3506W-30N15-B
6W	353	30°	MAR3506W-30N30-B
6W	430	40°	MAR3506W-30N40-B
6W	415	55°	MAR3506W-30N55-B

ORBIT

Φ45 Recessed Adjustable Spotlight



view on website



cutout :58mm



Adjustable Optic

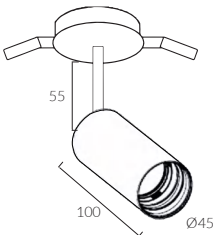

-  White Painted
-  Black Painted

- IP Rating:** IP20 and IP44 options
- Optics:** 15°/24°/36°/50°
- UGR:** <10
- CRI:** 98Ra
- Lifetime:** >50,000 hrs (L70 B10)
- CCT:** 2700K/3000K
- Typical Source Efficacy (lm/W):** 110
- Control:** On/off, Mains Dim, 0/1-10V, Dali, Zigbee, Casambi
- Binning:** 2 Step MacAdams
- Input:** AC220-240V 50/60Hz
- Output:** DC 36V 200mA 8W
DC 36V 250mA 10W
- Ambient temp:** -20 °C to 45 °C
- Class:** II
- Optional accessories:** Honeycomb louvre, Solite Lense, Spread Lense, Colour Filter

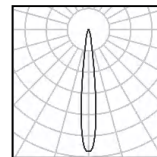

10W Ra98 3000K 15°

h(m)	E lx	D(m)
0.5	8822	0.15
1.0	2206	0.30
1.5	980	0.45
2.0	551	0.60
2.5	353	0.76
3.0	245	0.91

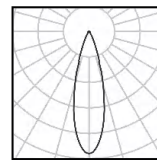

10W Ra98 3000K 24°

h(m)	E lx	D(m)
0.5	6615	0.23
1.0	1654	0.46
1.5	735	0.69
2.0	413	0.92
2.5	265	1.15
3.0	184	1.37

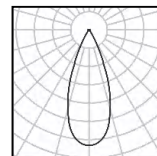

10W Ra98 3000K 36°

h(m)	E lx	D(m)
0.5	3458	0.32
1.0	864	0.65
1.5	384	0.97
2.0	216	1.29
2.5	138	1.61
3.0	96	1.94

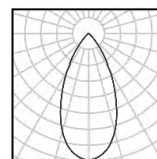

10W Ra98 3000K 50°

h(m)	E lx	D(m)
0.5	2048	0.45
1.0	512	0.89
1.5	228	1.34
2.0	128	1.79
2.5	82	2.24
3.0	57	2.68



W system	lm system	optics	code
10W	501	15°	MAR4510W-30N15-B
10W	653	24°	MAR4510W-30N24-B
10W	692	36°	MAR4510W-30N36-B
10W	676	50°	MAR4510W-30N50-B

ORBIT

Φ55 Recessed Adjustable Spotlight



view on website



cutout :58mm



Adjustable Optic

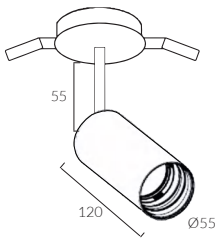

IP Rating:	IP20 and IP44 options
Optics:	12°/20°/30°/40°
UGR:	<10
CRI:	98Ra
Lifetime:	>50,000 hrs (L70 B10)
CCT:	2700K/3000K
Typical Source	
Efficacy (lm/W):	110
Control:	On/off, Mains Dim, 0/1-10V, Dali, Zigbee, Casambi
Binning:	2 Step MacAdams
Input:	AC220-240V 50/60Hz
Output:	DC 36V 250mA 10W DC 36V 300mA 12W DC 36V 350mA 15W
Ambient temp:	-20 C to 45 C
Class:	II
Optional accessories:	Honeycomb louvre, Solite Lense, Spread Lense, Colour Filter

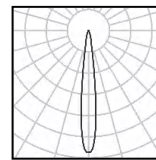

15W Ra98 3000K 12°

h(m)	E(lx)	D(m)
0.5	19862	0.11
1.0	4965	0.22
1.5	2207	0.33
2.0	1241	0.43
2.5	794	0.54
3.0	552	0.65

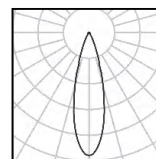

15W Ra98 3000K 20°

h(m)	E(lx)	D(m)
0.5	11574	0.18
1.0	2894	0.36
1.5	1286	0.54
2.0	723	0.72
2.5	463	0.90
3.0	322	1.08

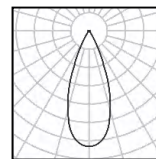

15W Ra98 3000K 30°

h(m)	E(lx)	D(m)
0.5	6165	0.27
1.0	1541	0.54
1.5	685	0.80
2.0	385	1.07
2.5	247	1.34
3.0	171	1.61

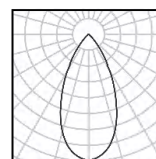

15W Ra98 3000K 40°

h(m)	E(lx)	D(m)
0.5	2648	0.38
1.0	662	0.76
1.5	294	1.15
2.0	166	1.53
2.5	106	1.91
3.0	74	2.29



W system	lm system	optics	code
10W	639	12°	MAR5510W-30N12-B
10W	684	20°	MAR5510W-30N20-B
10W	738	30°	MAR5510W-30N30-B
10W	700	40°	MAR5510W-30N40-B



W system	lm system	optics	code
12W	747	12°	MAR5512W-30N12-B
12W	749	20°	MAR5512W-30N20-B
12W	803	30°	MAR5512W-30N30-B
12W	760	40°	MAR5512W-30N40-B



W system	lm system	optics	code
15W	808	12°	MAR5515W-30N12-B
15W	896	20°	MAR5515W-30N20-B
15W	956	30°	MAR5515W-30N30-B
15W	906	40°	MAR5515W-30N40-B

ORBIT

Φ65 Recessed Adjustable Spotlight



view on website



Adjustable Optic

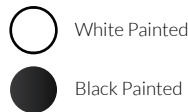
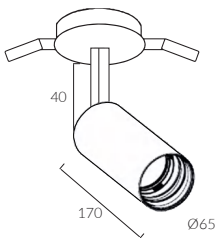

IP Rating:	IP20 and IP44 options
Optics:	15°/24°/36°/50°
UGR:	<10
CRI:	98Ra
Lifetime:	>50,000 hrs (L70 B10)
CCT:	2700K/3000K
Typical Source	
Efficacy (lm/W):	110
Control:	On/off, Mains Dim, 0/1-10V, Dali, Zigbee, Casambi
Binning:	2 Step MacAdams
Input:	AC220-240V 50/60Hz
Output:	DC 36V 500mA 20W DC 36V 600mA 25W DC 36V 700mA 30W
Ambient temp:	-20 C to 45 C
Class:	II
Optional accessories:	Honeycomb louvre, Solite Lense, Spread Lense, Colour Filter

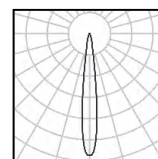

30W Ra98 3000K 15°

h(m)	E(lx)	D(m)
0.5	36897	0.12
1.0	9224	0.25
1.5	4100	0.37
2.0	2306	0.50
2.5	1476	0.62
3.0	1025	0.75

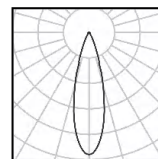

30W Ra98 3000K 24°

h(m)	E(lx)	D(m)
1.0	29283	0.18
2.0	7321	0.36
3.0	3254	0.53
4.0	1830	0.71
5.0	1171	0.89
6.0	813	1.07

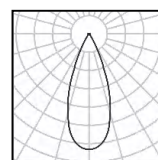

30W Ra98 3000K 36°

h(m)	E(lx)	D(m)
1.0	11973	0.32
2.0	2993	0.63
3.0	1330	0.95
4.0	748	1.26
5.0	479	1.58
6.0	333	1.89



W system	lm system	optics	code
20W	1348	15°	MAR6520W-30N15-B
20W	1595	24°	MAR6520W-30N24-B
20W	1643	36°	MAR6520W-30N36-B
20W	1369	50°	MAR6520W-30N50-B



W system	lm system	optics	code
25W	1503	15°	MAR6525W-30N15-B
25W	1946	24°	MAR6525W-30N24-B
25W	1909	36°	MAR6525W-30N36-B
25W	1825	50°	MAR6525W-30N50-B



W system	lm system	optics	code
30W	1706	15°	MAR6530W-30N15-B
30W	2219	24°	MAR6530W-30N24-B
30W	2184	36°	MAR6530W-30N36-B
30W	1965	50°	MAR6530W-30N50-B

ORBIT

Φ45 Recessed Contour Spotlight



Adjustable Optic



Recessed Trim

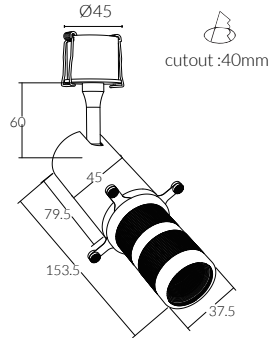

view on website



Black Painted



Recessed Trimless

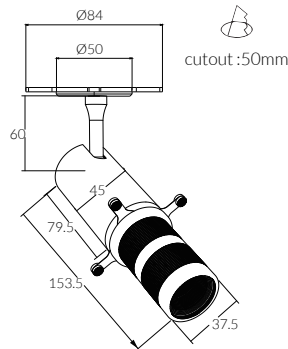

view on website

- IP Rating:** IP20
- Optics:** Framing
- UGR:** < 10
- CRI:** 98Ra
- Lifetime:** >50,000 hrs (L70 B10)
- CCT:** 2700K/3000K
- Typical Source**
- Efficacy (lm/W):** 110
- Control:** On/off, Mains Dim, 0/1-10V, Dali, Zigbee, Casambi
- Binning:** 2 Step MacAdams
- Input:** AC220-240V 50/60Hz
- Output:** DC 36V 250mA 10W
- Ambient temp:** -20 °C to 45 °C
- Class:** II

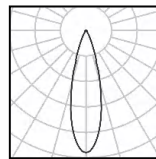

10W Ra98 3000K 24°

h(m)	E(lx)	D(m)
0.5	3216	0.21
1.0	804	0.42
1.5	357	0.63
2.0	201	0.84
2.5	129	1.04
3.0	89	1.25

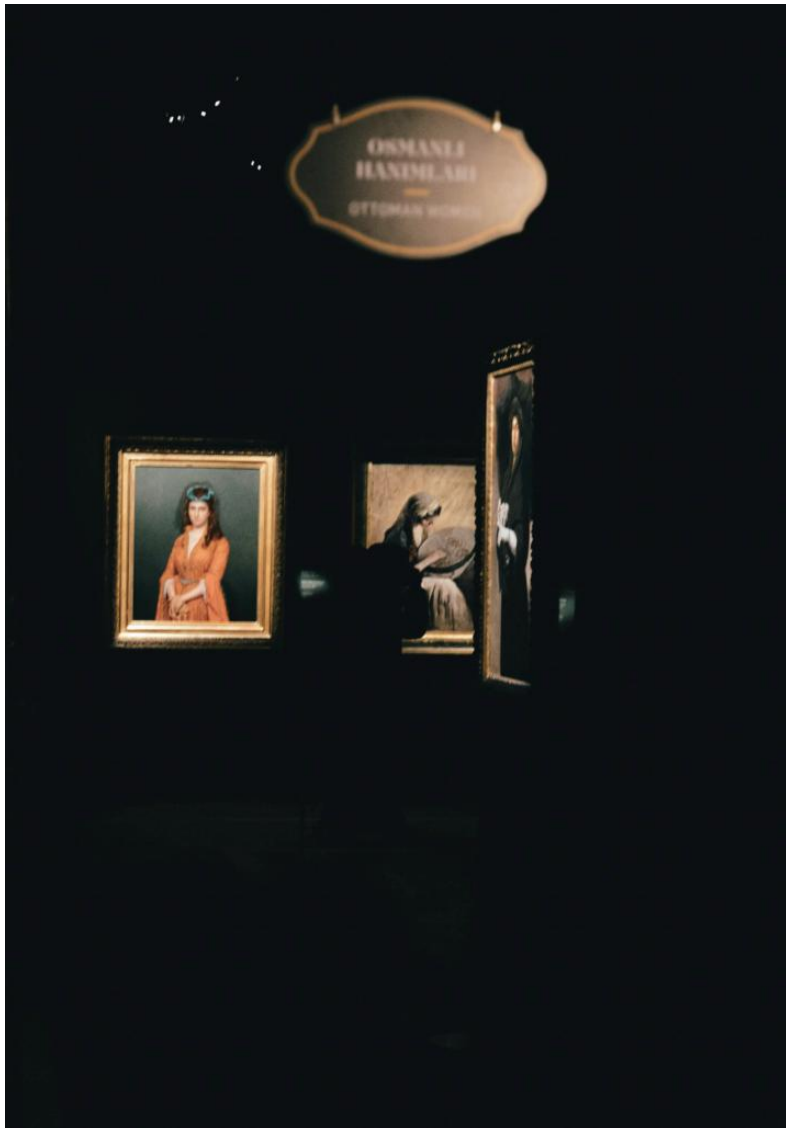

W system	lm system	code
10W	239	MARC4510W



W system	lm system	code
10W	239	MATC4510W

DIVINO

Φ35 Recessed Adjustable Spotlight



Adjustable Optic



Black Painted



cutout :40mm

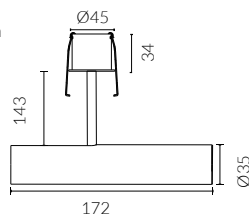

Recessed Trim



view on website



cutout :36mm

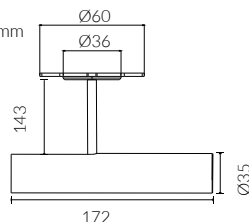

Recessed Trimless



view on website

IP Rating:	IP20 and IP44 options
Optics:	15°/30°/40°/55°
UGR:	<10
CRI:	98Ra
Lifetime:	>50,000 hrs (L70 B10)
CCT:	2700K/3000K
Typical Source	
Efficacy (lm/W):	110
Control:	On/off, Mains Dim, 0/1-10V, Dali, Zigbee, Casambi
Binning:	2 Step MacAdams
Input:	AC220-240V 50/60Hz
Output:	DC 36V 300mA 12W
Ambient temp:	-20 °C to 45 °C
Class:	II
Optional accessories:	Honeycomb louvre, Solite Lense, Spread Lense, Colour Filter

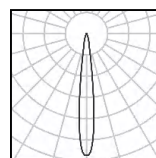

12W Ra98 3000K 15°

h(m)	E(lx)	D(m)
0.5	7106	0.14
1.0	1777	0.27
1.5	790	0.41
2.0	444	0.55
2.5	284	0.68
3.0	197	0.82

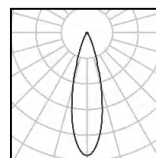

12W Ra98 3000K 30°

h(m)	E(lx)	D(m)
0.5	3379	0.28
1.0	845	0.56
1.5	375	0.84
2.0	211	1.12
2.5	135	1.40
3.0	94	1.68

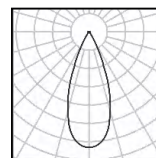

12W Ra98 3000K 40°

h(m)	E(lx)	D(m)
0.5	2710	0.38
1.0	678	0.75
1.5	301	1.13
2.0	169	1.50
2.5	108	1.88
3.0	75	2.26

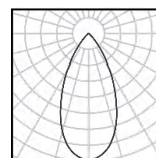

12W Ra98 3000K 55°

h(m)	E(lx)	D(m)
0.5	1235	0.51
1.0	309	1.01
1.5	137	1.52
2.0	77	2.03
2.5	49	2.54
3.0	34	3.04



W system	lm system	optics	code
12W	427	15°	MAR35L12W-30N15-B
12W	582	30°	MAR35L12W-30N30-B
12W	734	40°	MAR35L12W-30N40-B
12W	703	55°	MAR35L12W-30N55-B



W system	lm system	optics	code
12W	427	15°	MAT35L12W-30N15-B
12W	582	30°	MAT35L12W-30N30-B
12W	734	40°	MAT35L12W-30N40-B
12W	703	55°	MAT35L12W-30N55-B

SURFACE

EVOLINE / ACME / BELLA / GLAMO / ARTFOCUS /

ORBIT / CHIC / DIVINO / FOLD / FLOW / RING /

BOLUX

EVOLINE

67X64 Surface Fixed Square



view on website



Fixed Optic

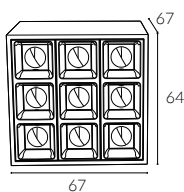
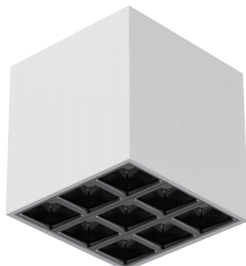

Bezel

-  White Painted
-  Black Painted

IP Rating:	IP20 and IP44 options
Optics:	50°
UGR:	<17
CRI:	92Ra
Lifetime:	>50,000 hrs (L70 B10)
CCT:	3000K/3500K
Typical Source	
Efficacy (lm/W):	113
Control:	On/off, Mains Dim, 0/1-10V, Dali, Zigbee, Casambi
Binning	2 Step MacAdams
Input:	AC220-240V 50/60Hz
Output:	DC 27V 300mA 8W
Ambient temp:	-20 °C to 45 °C
Class:	II
Material:	Fine aluminium 6063A

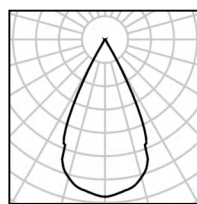

8W Ra92 3000K 50°

h(m)	E(lx)	D(m)
0.5	907	0.48
1.0	227	0.96
1.5	101	1.44
2.0	57	1.93
2.5	36	2.41
3.0	25	2.89

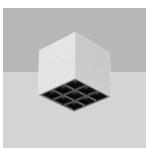

W system	lm system	optics	code
8W	458	50°	ESQ0908W-30N50-W

Φ57 Engine Surface Fixed Light



view on website



Fixed Optic

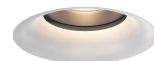

-C
optional curve baffle

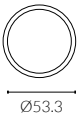
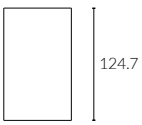

-  White Painted
-  Antique Bronze
-  Black Painted
-  Solid Brass
-  Brushed Grey
-  Faceted Brass

- IP Rating:** IP20 and IP44 options
- Optics:** 15°/24°/36°
- UGR:** <10
- CRI:** 98Ra
- Lifetime:** >50,000 hrs (L70 B10)
- CCT:** 2700K/3000K/3500K/4000K/5000K/
2000K-3000K/1800K-4000K/2700K-6000K

- Typical Source**
- Efficacy (lm/W):** 110
- Control:** On/off, Mains Dim, 0/1-10V, Dali, Zigbee, Casambi
- Binning** 2 Step MacAdams
- Input:** AC220-240V 50/60Hz
- Output:** DC 36V 150mA 6W
DC 36V 200mA 8W
DC 36V 250mA 10W

Ambient temp: -20 °C to 45 °C

Class: II

Optional accessories: Honeycomb louvre, Solite Lense, Spread Lense,
Colour Filter

Material: Fine aluminium 6063A

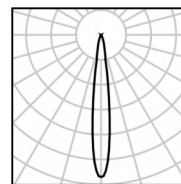

10W Ra98 3000K 15°

h(m)	E(lx)	D(m)
0.5	10728	0.15
1.0	2682	0.31
1.5	1192	0.46
2.0	671	0.61
2.5	429	0.77
3.0	298	0.92

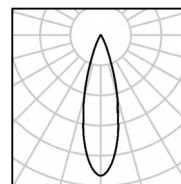

10W Ra98 3000K 24°

h(m)	E(lx)	D(m)
0.5	7580	0.21
1.0	1895	0.42
1.5	842	0.63
2.0	474	0.84
2.5	303	1.04
3.0	211	1.25

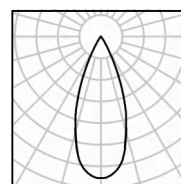

10W Ra98 3000K 36°

h(m)	E(lx)	D(m)
0.5	4206	0.28
1.0	1051	0.57
1.5	467	0.85
2.0	263	1.14
2.5	168	1.42
3.0	117	1.71



W system	lm system	optics	code
6W	367	15°	SFE5706W-30N15-B
6W	349	24°	SFE5706W-30N24-B
6W	340	36°	SFE5706W-30N36-B



W system	lm system	optics	code
8W	419	15°	SFE5708W-30N15-B
8W	470	24°	SFE5708W-30N24-B
8W	456	36°	SFE5708W-30N36-B







W system	lm system	optics	code
10W	462	15°	SFE5710W-30N15-B
10W	628	24°	SFE5710W-30N24-B
10W	616	36°	SFE5710W-30N36-B

Φ68 Engine Surface Fixed Light

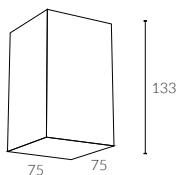

Fixed Optic



-  White Painted
-  Black Painted
-  Antique Bronze
-  Brushed Grey



view on website

- IP Rating:** IP20 and IP44 options
- Optics:** 15°/24°/36°/50°
- UGR:** <10
- CRI:** 98Ra
- Lifetime:** >50,000 hrs (L70 B10)
- CCT:** 2700K/3000K/3500K/4000K/5000K/
2000K-3000K/1800K-4000K/2700K-6000K
- Typical Source**
- Efficacy (lm/W):** 110
- Control:** On/off, Mains Dim, 0/1-10V, Dali, Zigbee, Casambi
- Binning** 2 Step MacAdams
- Input:** AC220-240V 50/60Hz
- Output:** DC 36V 200mA 8W
DC 36V 250mA 10W
DC 36V 300mA 12W
- Ambient temp:** -20 C to 45 C
- Class:** II
- Optional accessories:** Honeycomb louvre, Solite Lense, Spread Lense,
Colour Filter
- Material:** Fine aluminium 6063A

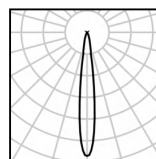

12W Ra98 3000K 15°

h(m)	E(lx)	D(m)
0.5	10897	0.17
1.0	2724	0.33
1.5	1211	0.50
2.0	681	0.66
2.5	436	0.83
3.0	303	0.99

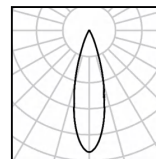

12W Ra98 3000K 24°

h(m)	E(lx)	D(m)
0.5	8621	0.20
1.0	2155	0.41
1.5	958	0.61
2.0	539	0.81
2.5	345	1.02
3.0	239	1.22

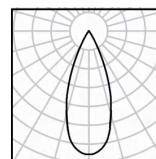

12W Ra98 3000K 36°

h(m)	E(lx)	D(m)
0.5	4792	0.28
1.0	1198	0.55
1.5	532	0.83
2.0	300	1.10
2.5	192	1.38
3.0	133	1.65

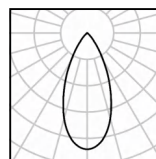

12W Ra98 3000K 50°

h(m)	E(lx)	D(m)
0.5	1608	0.47
1.0	402	0.93
1.5	179	1.40
2.0	100	1.87
2.5	64	2.33
3.0	45	2.80

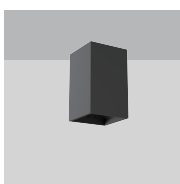

W system	lm system	optics	code
8W	487	15°	SFQE6808W-30N15-B
8W	503	24°	SFQE6808W-30N24-B
8W	492	36°	SFQE6808W-30N36-B
8W	427	50°	SFQE6808W-30N50-B

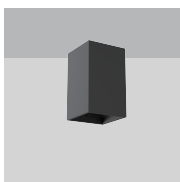

W system	lm system	optics	code
10W	553	15°	SFQE6810W-30N15-B
10W	575	24°	SFQE6810W-30N24-B
10W	565	36°	SFQE6810W-30N36-B
10W	485	50°	SFQE6810W-30N50-B

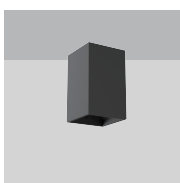

W system	lm system	optics	code
12W	717	15°	SFQE6812W-30N15-B
12W	760	24°	SFQE6812W-30N24-B
12W	750	36°	SFQE6812W-30N36-B
12W	640	50°	SFQE6812W-30N50-B

BELLA

Φ41 Surface Zoomable 20°-50° Spotlight



Adjustable Optic



Surface Minimal

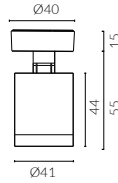

view on website



White Painted



Black Painted



Antique Bronze



Brushed Grey



Surface Standard

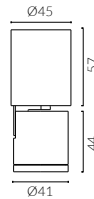

view on website

IP Rating:	IP20
Optics:	Zoomable 20°-50°
UGR:	<17
CRI:	92Ra
Lifetime:	>50,000 hrs (L70 B10)
CCT:	3000K/3500K/2700-6000K
Typical Source Efficacy (lm/W):	96
Control:	On/off, Mains Dim, 0/1-10V, Dali, Zigbee, Casambi
Binning	2 Step MacAdams
Input:	AC220-240V 50/60Hz
Output:	DC 12V 350mA 6W
Ambient temp:	-20 C to 45 C
Class:	II
Material:	Fine aluminium 6063A

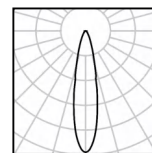

6W Ra92 3000K 20°

h(m)	E(lx)	D(m)
0.5	2355	0.20
1.0	589	0.40
1.5	262	0.59
2.0	147	0.79
2.5	94	0.99
3.0	65	1.19

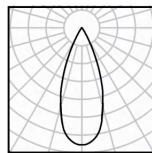

6W Ra92 3000K 30°

h(m)	E(lx)	D(m)
0.5	1378	0.29
1.0	344	0.58
1.5	153	0.88
2.0	86	1.17
2.5	55	1.46
3.0	38	1.75

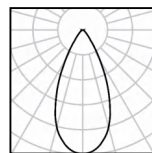

6W Ra92 3000K 50°

h(m)	E(lx)	D(m)
0.5	616	0.47
1.0	154	0.95
1.5	68	1.42
2.0	38	1.90
2.5	25	2.37
3.0	17	2.85



W system	lm system	optics	code
6W	292-296	20°- 50°	STM4106W-30N2050-B



W system	lm system	optics	code
6W	292-296	20°- 50°	STS4106W-30N2050-B

BELLA

Φ41 Surface Zoomable 20°-50° Wall Fixtures/Ceilings



Adjustable Optic

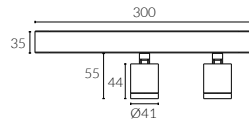

2 Spots Surface



view on website

○ White Painted

● Black Painted

● Antique Bronze

● Brushed Grey

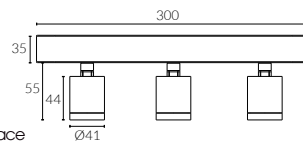

3 Spots Surface



view on website

IP Rating:	IP20
Optics:	Zoomable 20°-50°
UGR:	<17
CRI:	92Ra
Lifetime:	>50,000 hrs (L70 B10)
CCT:	3000K/3500K/2700-6000K
Typical Source Efficacy (lm/W):	96
Control:	On/off, Mains Dim, 0/1-10V, Dali, Zigbee, Casambi
Binning	2 Step MacAdams
Input:	AC220-240V 50/60Hz
Output:	DC 12V 350mA 6Wx2 / 6Wx3
Ambient temp:	-20 C to 45 C
Class:	II
Material:	Fine aluminium 6063A

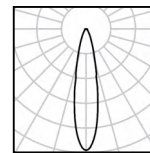

6W Ra92 3000K 20°

h(m)	E(lx)	D(m)
0.5	2355	0.20
1.0	589	0.40
1.5	262	0.59
2.0	147	0.79
2.5	94	0.99
3.0	65	1.19

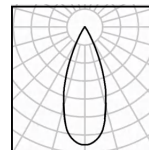

6W Ra92 3000K 30°

h(m)	E(lx)	D(m)
0.5	1378	0.29
1.0	344	0.58
1.5	153	0.88
2.0	86	1.17
2.5	55	1.46
3.0	38	1.75

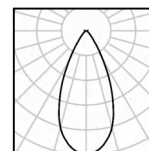

6W Ra92 3000K 50°

h(m)	E(lx)	D(m)
0.5	616	0.47
1.0	154	0.95
1.5	68	1.42
2.0	38	1.90
2.5	25	2.37
3.0	17	2.85



W system	lm system	optics	code
6W*2	292*2-296*2	20°- 50°	ST24106WX2-30N2050-B



W system	lm system	optics	code
6W*3	292*3-296*3	20°- 50°	ST34106WX3-30N2050-B

Φ68 Surface Zoomable 15°-50° Spotlight



Adjustable Optic

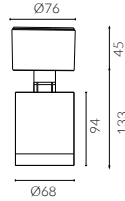

[view on website](#)

Surface Adjustable



Black Painted

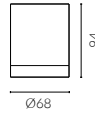

[view on website](#)

Surface Fixed

IP Rating: IP20
Optics: Zoomable 15°-50°
UGR: <17
CRI: 98Ra
Lifetime: >50,000 hrs (L70 B10)
CCT: 2700K/3000K/3500K/4000K/5000K/
 2000K-3000K/1800K-4000K/2700K-6000K

Typical Source

Efficacy (lm/W): 110
Control: On/off, Mains Dim, 0/1-10V, Dali, Zigbee, Casambi
Binning: 2 Step MacAdams
Input: AC220-240V 50/60Hz
Output: DC 36V 300mA 12W
Ambient temp: -20 °C to 45 °C
Class: II
Material: Fine aluminium 6063A

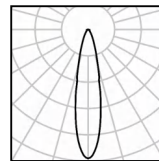

12W Ra98 3000K 15°

h(m)	E(lx)	D(m)
0.5	12099	0.14
1.0	3025	0.27
1.5	1344	0.41
2.0	756	0.54
2.5	484	0.68
3.0	336	0.81

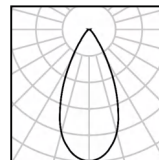

12W Ra98 3000K 40°

h(m)	E(lx)	D(m)
0.5	2174	0.38
1.0	544	0.76
1.5	242	1.14
2.0	136	1.52
2.5	87	1.90
3.0	60	2.28



W system	lm system	optics	code
12W	756-747	15°- 50°	STA6812W-30N1550-B



W system	lm system	optics	code
12W	756-747	15°- 50°	STF6812W-30N1550-B

GLAMO

Φ68 Surface Contour Spotlight



view on website



Adjustable Optic

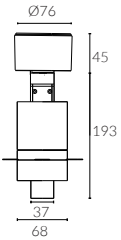

 Black Painted

IP Rating: IP20
Optics: Framing
UGR: <10
CRI: 92Ra
Lifetime: >50,000 hrs (L70 B10)
CCT: 2700K/3000K/3500K/4000K/5000K/
 2000K-3000K/1800K-4000K/2700K-6000K

Typical Source Efficacy (lm/W): 113
Control: On/off, Mains Dim, 0/1-10V, Dali, Zigbee, Casambi
Binning: 2 Step MacAdams
Input: AC220-240V 50/60Hz
Output: DC 36V 250mA 10W
Ambient temp: -20 °C to 45 °C
Class: II
Material: Fine aluminium 6063A

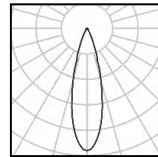

10W Ra98 3000K 24°

h(m)	E lx	D(m)
0.5	3216	0.21
1.0	804	0.42
1.5	357	0.63
2.0	201	0.84
2.5	129	1.04
3.0	89	1.25



W system	lm system	code
10W	239	STC6810W

ARTFOCUS

Φ36 Surface Spotlight

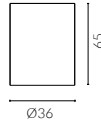

Surface Fixed



view on website



Adjustable Optic

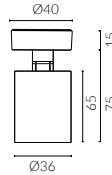

Surface Adjustable



view on website



White Painted

Black Painted

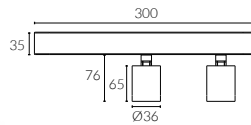

2 Spots Surface



view on website

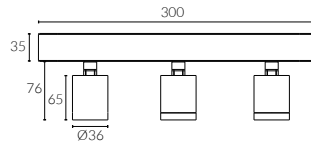

3 Spots Surface



view on website

- IP Rating:** IP20 and IP44 options
- Optics:** 15°/24°/36°
- UGR:** <10
- CRI:** 92Ra
- Lifetime:** >50,000 hrs (L70 B10)
- CCT:** 2700K/3000K/3500K/4000K/5000K/
2000K-3000K/1800K-4000K/2700K-6000K
- Typical Source Efficacy (lm/W):** 133
- Control:** On/off, Mains Dim, 0/1-10V, Dali, Zigbee, Casambi
- Binning** 2 Step MacAdams
- Input:** AC220-240V 50/60Hz
- Output:** DC 36V 150mA 6W
- Ambient temp:** -20 °C to 45 °C
- Class:** II
- Material:** Fine aluminium 6063A

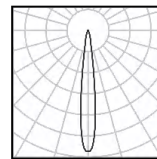

6W Ra98 3000K 15°

h(m)	E(lx)	D(m)
0.5	4937	0.14
1.0	1234	0.27
1.5	549	0.41
2.0	309	0.54
2.5	197	0.68
3.0	137	0.81

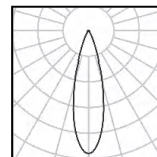

6W Ra98 3000K 28°

h(m)	E(lx)	D(m)
0.5	2848	0.25
1.0	712	0.49
1.5	316	0.74
2.0	178	0.98
2.5	114	1.23
3.0	79	1.47

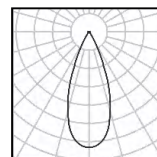

6W Ra98 3000K 36°

h(m)	E(lx)	D(m)
0.5	1706	0.31
1.0	426	0.62
1.5	190	0.93
2.0	107	1.25
2.5	68	1.56
3.0	47	1.87

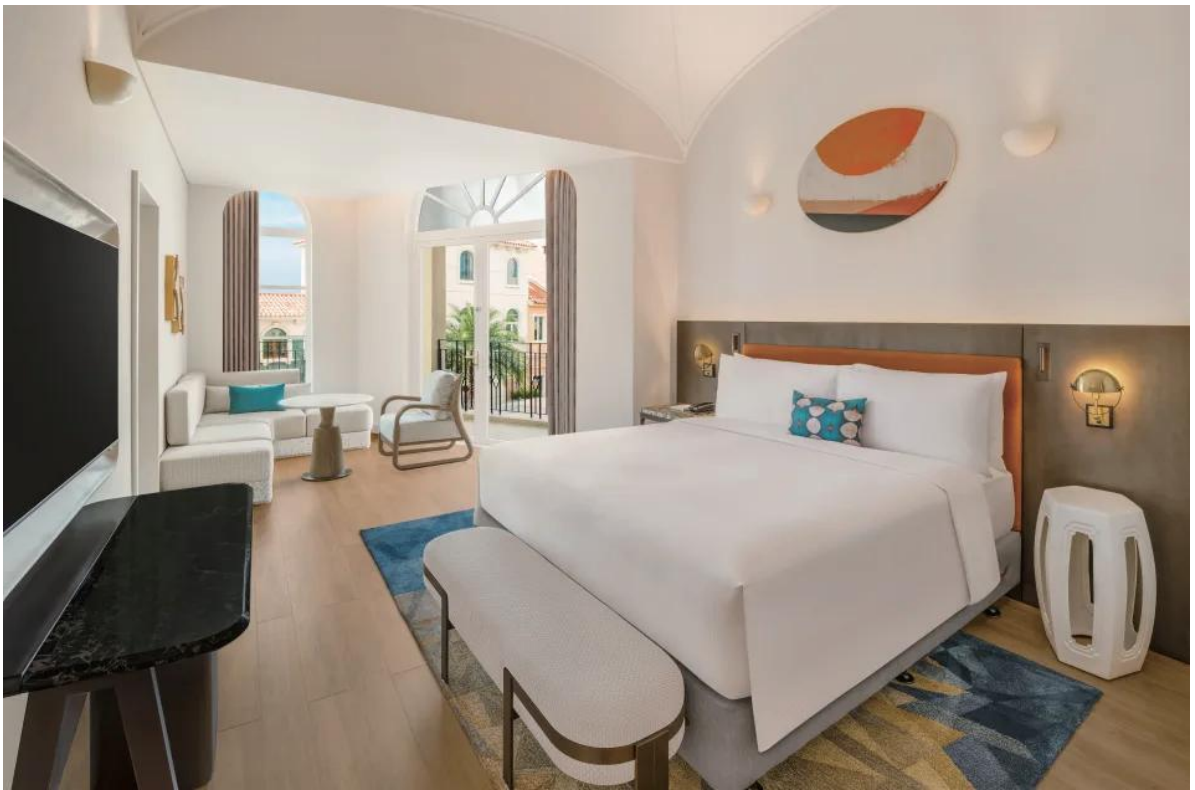

DuraGreen project:
Curio Hotel by Hilton



W system	lm system	optics	code
6W	373	15°	SF3606W-30N15-B
6W	445	24°	SF3606W-30N24-B
6W	446	36°	SF3606W-30N36-B



W system	lm system	optics	code
6W	373	15°	SA3606W-30N15-B
6W	445	24°	SA3606W-30N24-B
6W	446	36°	SA3606W-30N36-B



W system	lm system	optics	code
6W*2	373*2	15°	SA3606WX2-30N15-B
6W*2	445*2	24°	SA3606WX2-30N24-B
6W*2	446*2	36°	SA3606WX2-30N36-B



W system	lm system	optics	code
6W*3	373*3	15°	SA3606WX3-30N15-B
6W*3	445*3	24°	SA3606WX3-30N24-B
6W*3	446*3	36°	SA3606WX3-30N36-B

ORBIT

Φ55 Surface Fixed Light



Fixed



White Painted



Black Painted



view on website

Designed for super eye comfort,
minimum glare

IP Rating:	IP20 and IP44 options
Optics:	12°/20°/30°/40°
UGR:	<10
CRI:	98Ra
Lifetime:	>50,000 hrs (L70 B10)
CCT:	2700K/3000K
Typical Source	
Efficacy (lm/W):	110
Control:	On/off, Mains Dim, 0/1-10V, Dali, Zigbee, Casambi
Binning:	2 Step MacAdams
Input:	AC220-240V 50/60Hz
Output:	DC 36V 250mA 10W DC 36V 300mA 12W DC 36V 350mA 15W
Ambient temp:	-20 °C to 45 °C
Class:	II
Optional accessories:	Honeycomb louvre, Solite Lense, Spread Lense, Colour Filter

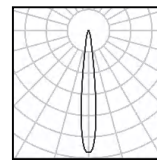

15W Ra98 3000K 12°

h(m)	E(lx)	D(m)
0.5	19862	0.11
1.0	4965	0.22
1.5	2207	0.33
2.0	1241	0.43
2.5	794	0.54
3.0	552	0.65

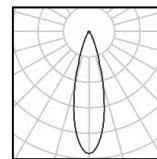

15W Ra98 3000K 20°

h(m)	E(lx)	D(m)
0.5	11574	0.18
1.0	2894	0.36
1.5	1286	0.54
2.0	723	0.72
2.5	463	0.90
3.0	322	1.08

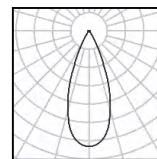

15W Ra98 3000K 30°

h(m)	E(lx)	D(m)
0.5	6165	0.27
1.0	1541	0.54
1.5	685	0.80
2.0	385	1.07
2.5	247	1.34
3.0	171	1.61

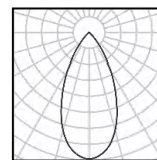

15W Ra98 3000K 40°

h(m)	E(lx)	D(m)
0.5	2648	0.38
1.0	662	0.76
1.5	294	1.15
2.0	166	1.53
2.5	106	1.91
3.0	74	2.29



W system	lm system	optics	code
10W	639	12°	MFS5510W-30N12-B
10W	684	20°	MFS5510W-30N20-B
10W	738	30°	MFS5510W-30N30-B
10W	700	40°	MFS5510W-30N40-B



W system	lm system	optics	code
12W	747	12°	MFS5512W-30N12-B
12W	749	20°	MFS5512W-30N20-B
12W	803	30°	MFS5512W-30N30-B
12W	760	40°	MFS5512W-30N40-B



W system	lm system	optics	code
15W	808	12°	MFS5515W-30N12-B
15W	896	20°	MFS5515W-30N20-B
15W	956	30°	MFS5515W-30N30-B
15W	906	40°	MFS5515W-30N40-B

ORBIT

Φ75 Surface Fixed Light



Fixed

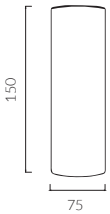

view on website



-  White Painted
-  Black Painted

Designed for super eye comfort,
minimum glare

IP Rating:	IP20 and IP44 options
Optics:	15°/24°/36°/55°
UGR:	<10
CRI:	98Ra
Lifetime:	>50,000 hrs (L70 B10)
CCT:	2700K/3000K
Typical Source	
Efficacy (lm/W):	110
Control:	On/off, Mains Dim, 0/1-10V, Dali, Zigbee, Casambi
Binning:	2 Step MacAdams
Input:	AC220-240V 50/60Hz
Output:	DC 36V 500mA 20W DC 36V 600mA 25W DC 36V 700mA 30W
Ambient temp:	-20 °C to 45 °C
Class:	II
Optional accessories:	Honeycomb louvre, Solite Lense, Spread Lense, Colour Filter

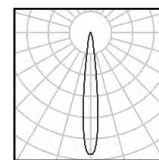

30W Ra98 3000K 15°

h(m)	E(lx)	D(m)
0.5	36897	0.12
1.0	9224	0.25
1.5	4100	0.37
2.0	2306	0.50
2.5	1476	0.62
3.0	1025	0.75

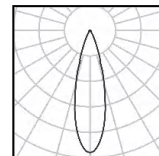

30W Ra98 3000K 24°

h(m)	E(lx)	D(m)
1.0	29283	0.18
2.0	7321	0.36
3.0	3254	0.53
4.0	1830	0.71
5.0	1171	0.89
6.0	813	1.07

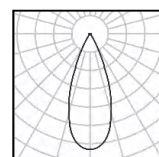

30W Ra98 3000K 36°

h(m)	E(lx)	D(m)
1.0	11973	0.32
2.0	2993	0.63
3.0	1330	0.95
4.0	748	1.26
5.0	479	1.58
6.0	333	1.89



W system	lm system	optics	code
20W	1348	15°	MFS7520W-30N15-B
20W	1595	24°	MFS7520W-30N24-B
20W	1643	36°	MFS7520W-30N36-B
20W	1369	50°	MFS7520W-30N50-B



W system	lm system	optics	code
25W	1503	15°	MFS7525W-30N15-B
25W	1946	24°	MFS7525W-30N24-B
25W	1909	36°	MFS7525W-30N36-B
25W	1825	50°	MFS7525W-30N50-B



W system	lm system	optics	code
30W	1706	15°	MFS7530W-30N15-B
30W	2219	24°	MFS7530W-30N24-B
30W	2184	36°	MFS7530W-30N36-B
30W	1965	50°	MFS7530W-30N50-B

CHIC

Φ73 Surface Adjustable Light



Adjustable Optic



view on website

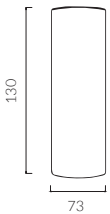

-  White Painted
-  Black Painted

IP Rating:	IP20 and IP44 options
Optics:	24°/36°
UGR:	< 10
CRI:	98Ra
Lifetime:	> 50,000 hrs (L70 B10)
CCT:	2700K/3000K
Typical Source	
Efficacy (lm/W):	110
Control:	On/off, Mains Dim, 0/1-10V, Dali, Zigbee, Casambi
Binning:	2 Step MacAdams
Input:	AC220-240V 50/60Hz
Output:	DC 36V 150mA 6W DC 36V 200mA 8W DC 36V 250mA 10W DC 36V 300mA 12W
Ambient temp:	-20 °C to 45 °C
Class:	II

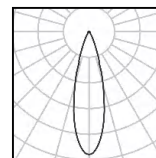

12W Ra98 3000K 24°

h(m)	E lx	D(m)
0.5	6463	0.24
1.0	1616	0.48
1.5	718	0.72
2.0	404	0.96
2.5	259	1.20
3.0	180	1.44

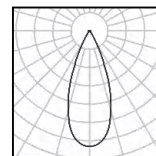

12W Ra98 3000K 36°

h(m)	E lx	D(m)
0.5	4042	0.31
1.0	1011	0.62
1.5	449	0.93
2.0	253	1.25
2.5	162	1.56
3.0	112	1.87



DuraGreen project:
Curio Resort by Hilton Hotel

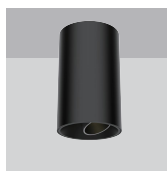

W system	lm system	optics	code
6W	311	24°	MFS7306W-30N24-B
6W	315	36°	MFS7306W-30N36-B

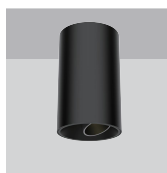

W system	lm system	optics	code
8W	444	24°	MFS7308W-30N24-B
8W	422	36°	MFS7308W-30N36-B

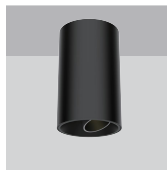

W system	lm system	optics	code
10W	518	24°	MFS7310W-30N24-B
10W	508	36°	MFS7310W-30N36-B

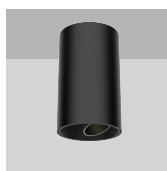

W system	lm system	optics	code
12W	567	24°	MFS7312W-30N24-B
12W	612	36°	MFS7312W-30N36-B

ORBIT

Φ35 Surface Adjustable Spotlight



view on website



Adjustable Optic

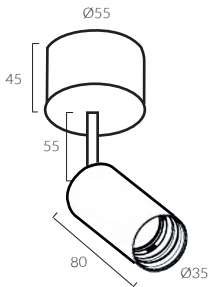

- IP Rating:** IP20 and IP44 options
- Optics:** 15°/30°/40°/55°
- UGR:** < 10
- CRI:** 98Ra
- Lifetime:** >50,000 hrs (L70 B10)
- CCT:** 2700K/3000K
- Typical Source Efficacy (lm/W):** 110
- Control:** On/off, Mains Dim, 0/1-10V, Dali, Zigbee, Casambi
- Binning:** 2 Step MacAdams
- Input:** AC220-240V 50/60Hz
- Output:** DC 36V 150mA 6W
- Ambient temp:** -20 °C to 45 °C
- Class:** II
- Optional accessories:** Honeycomb louvre, Solite Lens, Spread Lens, Colour Filter

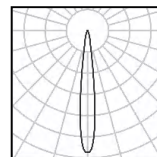

6W Ra98 3000K 15°

h(m)	E(lx)	D(m)
0.5	4391	0.14
1.0	1098	0.27
1.5	488	0.41
2.0	274	0.55
2.5	176	0.68
3.0	122	0.82

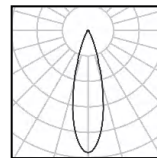

6W Ra98 3000K 30°

h(m)	E(lx)	D(m)
0.5	2085	0.28
1.0	521	0.55
1.5	232	0.83
2.0	130	1.10
2.5	83	1.38
3.0	58	1.65

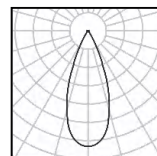

6W Ra98 3000K 40°

h(m)	E(lx)	D(m)
0.5	1572	0.38
1.0	393	0.76
1.5	175	1.15
2.0	98	1.53
2.5	63	1.91
3.0	44	2.29

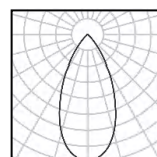

6W Ra98 3000K 55°

h(m)	E(lx)	D(m)
0.5	707	0.53
1.0	177	1.07
1.5	79	1.60
2.0	44	2.14
2.5	28	2.67
3.0	20	3.20



W system	lm system	optics	code
6W	267	15°	MAS3506W-30N15-B
6W	353	30°	MAS3506W-30N30-B
6W	430	40°	MAS3506W-30N40-B
6W	415	55°	MAS3506W-30N55-B

ORBIT

Φ45 Surface Adjustable Spotlight



Adjustable Optic

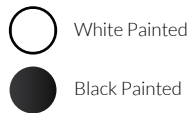
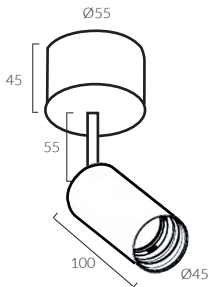

view on website

- IP Rating:** IP20 and IP44 options
- Optics:** 15°/24°/36°/50°
- UGR:** <10
- CRI:** 98Ra
- Lifetime:** >50,000 hrs (L70 B10)
- CCT:** 2700K/3000K
- Typical Source Efficacy (lm/W):** 110
- Control:** On/off, Mains Dim, 0/1-10V, Dali, Zigbee, Casambi
- Binning:** 2 Step MacAdams
- Input:** AC220-240V 50/60Hz
- Output:** DC 36V 200mA 8W
DC 36V 250mA 10W
- Ambient temp:** -20 °C to 45 °C
- Class:** II
- Optional accessories:** Honeycomb louvre, Solite Lense, Spread Lense, Colour Filter

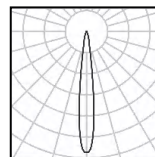

10W Ra98 3000K 15°

h(m)	E(lx)	D(m)
0.5	8822	0.15
1.0	2206	0.30
1.5	980	0.45
2.0	551	0.60
2.5	353	0.76
3.0	245	0.91

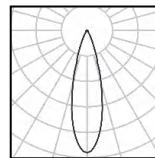

10W Ra98 3000K 24°

h(m)	E(lx)	D(m)
0.5	6615	0.23
1.0	1654	0.46
1.5	735	0.69
2.0	413	0.92
2.5	265	1.15
3.0	184	1.37

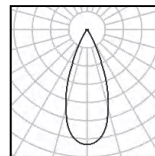

10W Ra98 3000K 36°

h(m)	E(lx)	D(m)
0.5	3458	0.32
1.0	864	0.65
1.5	384	0.97
2.0	216	1.29
2.5	138	1.61
3.0	96	1.94

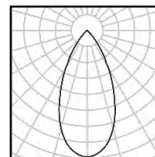

10W Ra98 3000K 50°

h(m)	E(lx)	D(m)
0.5	2048	0.45
1.0	512	0.89
1.5	228	1.34
2.0	128	1.79
2.5	82	2.24
3.0	57	2.68



DuraGreen project:
Soil Scent Club



W system	lm system	optics	code
10W	501	15°	MAS4510W-30N15-B
10W	653	24°	MAS4510W-30N24-B
10W	692	36°	MAS4510W-30N36-B
10W	676	50°	MAS4510W-30N50-B

ORBIT

Φ55 Surface Adjustable Spotlight



view on website



Adjustable Optic

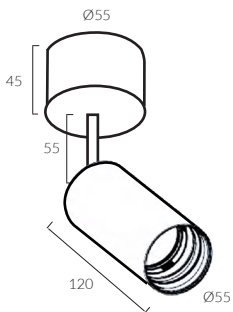

- White Painted
- Black Painted

- IP Rating:** IP20 and IP44 options
- Optics:** 12°/20°/30°/40°
- UGR:** < 10
- CRI:** 98Ra
- Lifetime:** >50,000 hrs (L70 B10)
- CCT:** 2700K/3000K
- Typical Source Efficacy (lm/W):** 110
- Control:** On/off, Mains Dim, 0/1-10V, Dali, Zigbee, Casambi
- Binning:** 2 Step MacAdams
- Input:** AC220-240V 50/60Hz
- Output:** DC 36V 350mA 15W
- Ambient temp:** -20 °C to 45 °C
- Class:** II
- Optional accessories:** Honeycomb louvre, Solite Lense, Spread Lense, Colour Filter

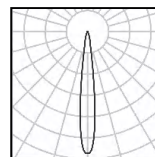

15W Ra98 3000K 12°

h(m)	E(lx)	D(m)
0.5	19862	0.11
1.0	4965	0.22
1.5	2207	0.33
2.0	1241	0.43
2.5	794	0.54
3.0	552	0.65

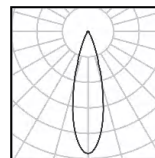

15W Ra98 3000K 20°

h(m)	E(lx)	D(m)
0.5	11574	0.18
1.0	2894	0.36
1.5	1286	0.54
2.0	723	0.72
2.5	463	0.90
3.0	322	1.08

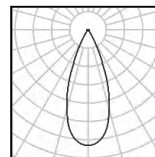

15W Ra98 3000K 30°

h(m)	E(lx)	D(m)
0.5	6165	0.27
1.0	1541	0.54
1.5	685	0.80
2.0	385	1.07
2.5	247	1.34
3.0	171	1.61

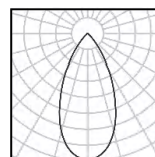

15W Ra98 3000K 40°

h(m)	E(lx)	D(m)
0.5	2648	0.38
1.0	662	0.76
1.5	294	1.15
2.0	166	1.53
2.5	106	1.91
3.0	74	2.29



DuraGreen project:
Michelin 3 Star DA VITTORIO



W system	lm system	optics	code
10W	639	12°	MAS5510W-30N12-B
10W	684	20°	MAS5510W-30N20-B
10W	738	30°	MAS5510W-30N30-B
10W	700	40°	MAS5510W-30N40-B



W system	lm system	optics	code
12W	747	12°	MAS5512W-30N12-B
12W	749	20°	MAS5512W-30N20-B
12W	803	30°	MAS5512W-30N30-B
12W	760	40°	MAS5512W-30N40-B



W system	lm system	optics	code
15W	808	12°	MAS5515W-30N12-B
15W	896	20°	MAS5515W-30N20-B
15W	956	30°	MAS5515W-30N30-B
15W	906	40°	MAS5515W-30N40-B

ORBIT

Φ65 Surface Adjustable Spotlight



view on website



Adjustable Optic

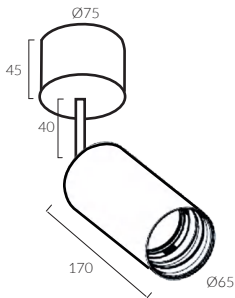

- IP Rating:** IP20 and IP44 options
- Optics:** 15°/24°/36°/50°
- UGR:** <10
- CRI:** 98Ra
- Lifetime:** >50,000 hrs (L70 B10)
- CCT:** 2700K/3000K
- Typical Source**
- Efficacy (lm/W):** 110
- Control:** On/off, Mains Dim, 0/1-10V, Dali, Zigbee, Casambi
- Binning:** 2 Step MacAdams
- Input:** AC220-240V 50/60Hz
- Output:** DC 36V 500mA 20W
DC 36V 600mA 25W
DC 36V 700mA 30W
- Ambient temp:** -20 °C to 45 °C
- Class:** II
- Optional accessories:** Honeycomb louvre, Solite Lense, Spread Lense, Colour Filter

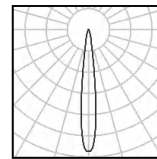

30W Ra98 3000K 15°

h(m)	E(lx)	D(m)
0.5	36897	0.12
1.0	9224	0.25
1.5	4100	0.37
2.0	2306	0.50
2.5	1476	0.62
3.0	1025	0.75

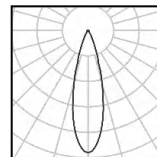

30W Ra98 3000K 24°

h(m)	E(lx)	D(m)
1.0	29283	0.18
2.0	7321	0.36
3.0	3254	0.53
4.0	1830	0.71
5.0	1171	0.89
6.0	813	1.07

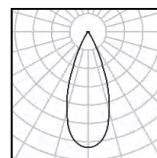

30W Ra98 3000K 36°

h(m)	E(lx)	D(m)
1.0	11973	0.32
2.0	2993	0.63
3.0	1330	0.95
4.0	748	1.26
5.0	479	1.58
6.0	333	1.89



DuraGreen project:
Minotti Showroom



W system	lm system	optics	code
20W	1348	15°	MAS6520W-30N15-B
20W	1595	24°	MAS6520W-30N24-B
20W	1643	36°	MAS6520W-30N36-B
20W	1369	50°	MAS6520W-30N50-B



W system	lm system	optics	code
25W	1503	15°	MAS6525W-30N15-B
25W	1946	24°	MAS6525W-30N24-B
25W	1909	36°	MAS6525W-30N36-B
25W	1825	50°	MAS6525W-30N50-B



W system	lm system	optics	code
30W	1706	15°	MAS6530W-30N15-B
30W	2219	24°	MAS6530W-30N24-B
30W	2184	36°	MAS6530W-30N36-B
30W	1965	50°	MAS6530W-30N50-B

ORBIT

Φ45 Surface Contour Spotlight



Adjustable Optic

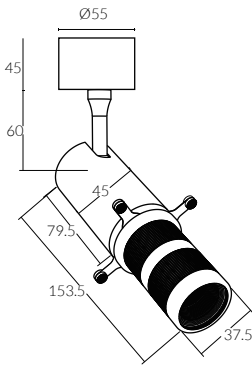

 Black Painted



view on website

IP Rating:	IP20
Optics:	Framing
UGR:	<10
CRI:	98Ra
Lifetime:	>50,000 hrs (L70 B10)
CCT:	2700K/3000K
Typical Source Efficacy (lm/W):	110
Control:	On/off, Mains Dim, 0/1-10V, Dali, Zigbee, Casambi
Binning:	2 Step MacAdams
Input:	AC220-240V 50/60Hz
Output:	DC 36V 250mA 10W
Ambient temp:	-20 C to 45 C
Class:	II

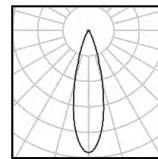

10W Ra98 3000K 24°

h(m)	E(lx)	D(m)
0.5	3216	0.21
1.0	804	0.42
1.5	357	0.63
2.0	201	0.84
2.5	129	1.04
3.0	89	1.25



W system	lm system	code
10W	239	MASC4510W

DIVINO

Φ35 Surface Adjustable Spotlight



Adjustable Optic

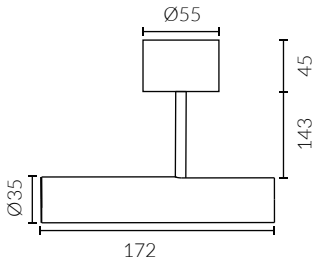

 Black Painted



view on website

- IP Rating:** IP20 and IP44 options
- Optics:** 15°/30°/40°/55°
- UGR:** < 10
- CRI:** 98Ra
- Lifetime:** >50,000 hrs (L70 B10)
- CCT:** 2700K/3000K
- Typical Source Efficacy (lm/W):** 110
- Control:** On/off, Mains Dim, 0/1-10V, Dali, Zigbee, Casambi
- Binning:** 2 Step MacAdams
- Input:** AC220-240V 50/60Hz
- Output:** DC 36V 300mA 12W
- Ambient temp:** -20 °C to 45 °C
- Class:** II
- Optional accessories:** Honeycomb louvre, Solite Lens, Spread Lens, Colour Filter

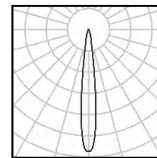

12W Ra98 3000K 15°

h(m)	E(lx)	D(m)
0.5	7106	0.14
1.0	1777	0.27
1.5	790	0.41
2.0	444	0.55
2.5	284	0.68
3.0	197	0.82

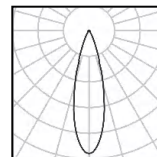

12W Ra98 3000K 30°

h(m)	E(lx)	D(m)
0.5	3379	0.28
1.0	845	0.56
1.5	375	0.84
2.0	211	1.12
2.5	135	1.40
3.0	94	1.68

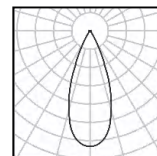

12W Ra98 3000K 40°

h(m)	E(lx)	D(m)
0.5	2710	0.38
1.0	678	0.75
1.5	301	1.13
2.0	169	1.50
2.5	108	1.88
3.0	75	2.26

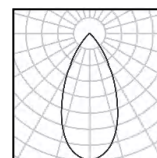

12W Ra98 3000K 55°

h(m)	E(lx)	D(m)
0.5	1235	0.51
1.0	309	1.01
1.5	137	1.52
2.0	77	2.03
2.5	49	2.54
3.0	34	3.04



W system	lm system	optics	code
12W	427	15°	MAS35L12W-30N15-B
12W	582	30°	MAS35L12W-30N30-B
12W	734	40°	MAS35L12W-30N40-B
12W	703	55°	MAS35L12W-30N55-B

FOLD

Φ45 Surface Adjustable Spotlight



Adjustable Optic

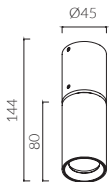

view on website

-  White Painted
-  Black Painted

- IP Rating:** IP20 and IP44 options
- Optics:** 15°/24°/36°/50°
- UGR:** < 10
- CRI:** 98Ra
- Lifetime:** >50,000 hrs (L70 B10)
- CCT:** 2700K/3000K
- Typical Source Efficacy (lm/W):** 110
- Control:** On/off, Mains Dim, 0/1-10V, Dali, Zigbee, Casambi
- Binning:** 2 Step MacAdams
- Input:** AC220-240V 50/60Hz
- Output:** DC 36V 200mA 8W
DC 36V 250mA 10W
- Ambient temp:** -20 °C to 45 °C
- Class:** II
- Optional accessories:** Honeycomb louvre, Solite Lense, Spread Lense, Colour Filter

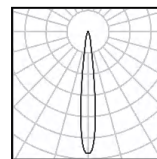

10W Ra98 3000K 15°

h(m)	E(lx)	D(m)
0.5	8822	0.15
1.0	2206	0.30
1.5	980	0.45
2.0	551	0.60
2.5	353	0.76
3.0	245	0.91

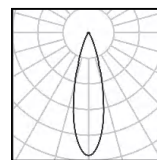

10W Ra98 3000K 24°

h(m)	E(lx)	D(m)
0.5	6615	0.23
1.0	1654	0.46
1.5	735	0.69
2.0	413	0.92
2.5	265	1.15
3.0	184	1.37

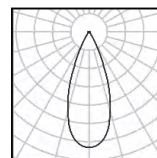

10W Ra98 3000K 36°

h(m)	E(lx)	D(m)
0.5	3458	0.32
1.0	864	0.65
1.5	384	0.97
2.0	216	1.29
2.5	138	1.61
3.0	96	1.94

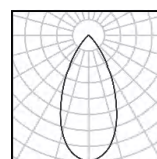

10W Ra98 3000K 50°

h(m)	E(lx)	D(m)
0.5	2048	0.45
1.0	512	0.89
1.5	228	1.34
2.0	128	1.79
2.5	82	2.24
3.0	57	2.68

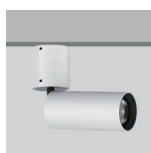
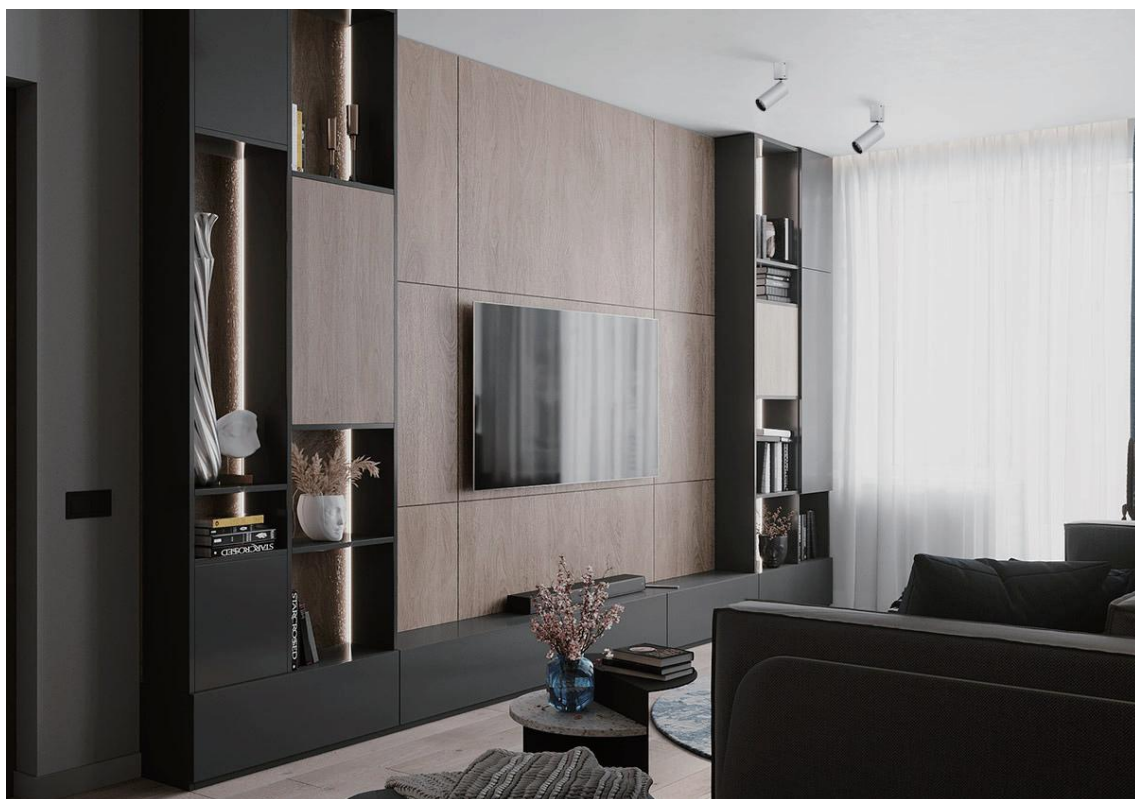

W system	lm system	optics	code
10W	501	15°	AFS4510W-30N15-B
10W	653	24°	AFS4510W-30N24-B
10W	692	36°	AFS4510W-30N36-B
10W	676	50°	AFS4510W-30N50-B

FLOW

Surface 3 Spots Linear



Fixed



view on website

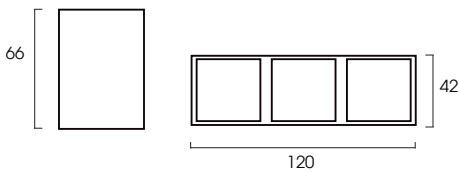

White Painted



Black Painted

IP Rating:	IP20 and IP44 options
Optics:	12°/24°/38°/50°/Wall Wash
UGR:	< 10
CRI:	92Ra
Lifetime:	>50,000 hrs (L70 B10)
CCT:	3000K
Typical Source	
Efficacy (lm/W):	113
Control:	On/off, Mains Dim, 0/1-10V, Dali, Zigbee, Casambi
Binning	2 Step MacAdams
Input:	AC220-240V 50/60Hz
Output:	DC 36V 200mA 8W DC 36V 250mA 10W
Ambient temp:	-20 °C to 45 °C
Class:	II

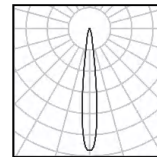

10W Ra92 3000K 12°

h(m)	E(lx)	D(m)
0.5	11477	0.13
1.0	2869	0.27
1.5	1275	0.40
2.0	717	0.53
2.5	459	0.67
3.0	319	0.80

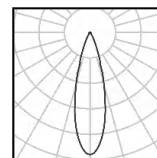

10W Ra92 3000K 24°

h(m)	E(lx)	D(m)
0.5	7647	0.16
1.0	1912	0.33
1.5	850	0.49
2.0	478	0.66
2.5	306	0.82
3.0	212	0.98

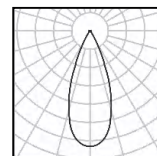

10W Ra92 3000K 38°

h(m)	E(lx)	D(m)
0.5	5017	0.25
1.0	1254	0.50
1.5	557	0.75
2.0	314	1.00
2.5	201	1.26
3.0	139	1.51

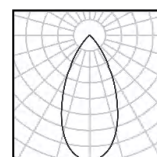

10W Ra92 3000K 50°

h(m)	E(lx)	D(m)
0.5	2771	0.43
1.0	693	0.87
1.5	308	1.30
2.0	173	1.73
2.5	111	2.16
3.0	77	2.60

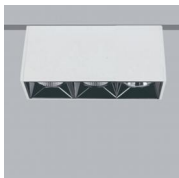

W system	lm system	optics	code
8W	707	12°	SFL0308W-30N12-B
8W	729	24°	SFL0308W-30N24-B
8W	703	38°	SFL0308W-30N38-B
8W	696	50°	SFL0308W-30N50-B

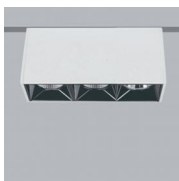

W system	lm system	optics	code
10W	869	12°	SFL0310W-30N12-B
10W	891	24°	SFL0310W-30N24-B
10W	868	38°	SFL0310W-30N38-B
10W	861	50°	SFL0310W-30N50-B

FLOW

Surface 5 Spots Linear



[view on website](#)



Fixed

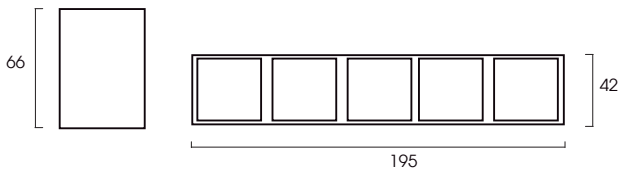

White Painted



Black Painted

- IP Rating:** IP20 and IP44 options
- Optics:** 12°/24°/38°/50°/Wall Wash
- UGR:** < 10
- CRI:** 92Ra
- Lifetime:** >50,000 hrs (L70 B10)
- CCT:** 3000K
- Typical Source Efficacy (lm/W):** 113
- Control:** On/off, Mains Dim, 0/1-10V, Dali, Zigbee, Casambi
- Binning:** 2 Step MacAdams
- Input:** AC220-240V 50/60Hz
- Output:** DC 36V 300mA 12W
DC 36V 350mA 15W
- Ambient temp:** -20 °C to 45 °C
- Class:** II

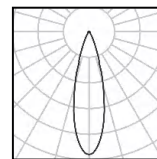

15W Ra92 3000K 24°

h(m)	E(lx)	D(m)
0.5	9378	0.21
1.0	2344	0.43
1.5	1042	0.64
2.0	586	0.86
2.5	375	1.07
3.0	260	1.29

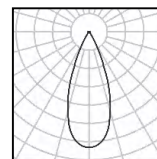

15W Ra92 3000K 38°

h(m)	E(lx)	D(m)
0.5	5017	0.33
1.0	1254	0.67
1.5	557	1.00
2.0	314	1.34
2.5	201	1.67
3.0	139	2.01

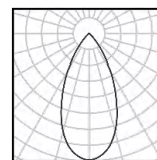

15W Ra92 3000K 50°

h(m)	E(lx)	D(m)
0.5	3325	0.50
1.0	831	1.00
1.5	369	1.50
2.0	208	1.99
2.5	133	2.49
3.0	92	2.99



W system	lm system	optics	code
12W	1075	12°	SFL0512W-30N12-B
12W	1059	24°	SFL0512W-30N24-B
12W	968	38°	SFL0512W-30N38-B
12W	1066	50°	SFL0512W-30N50-B



W system	lm system	optics	code
15W	1187	12°	SFL0515W-30N12-B
15W	1241	24°	SFL0515W-30N24-B
15W	1266	38°	SFL0515W-30N38-B
15W	1220	50°	SFL0515W-30N50-B

FLOW

Surface 10 Spots Linear



Fixed



view on website

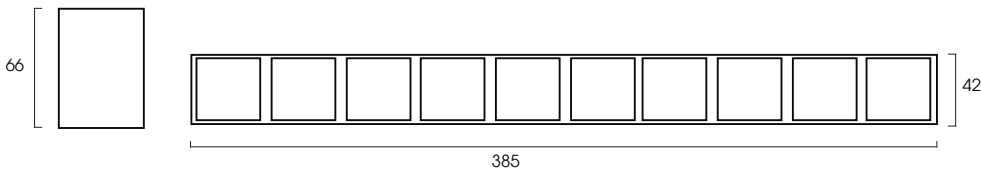

White Painted



Black Painted

IP Rating:	IP20 and IP44 options
Optics:	12°/24°/38°/50°/Wall Wash
UGR:	< 10
CRI:	92Ra
Lifetime:	> 50,000 hrs (L70 B10)
CCT:	3000K
Typical Source Efficacy (lm/W):	113
Control:	On/off, Mains Dim, 0/1-10V, Dali, Zigbee, Casambi
Binning	2 Step MacAdams
Input:	AC 220-240V 50/60Hz
Output:	DC 36V 500mA 20W DC 36V 600mA 25W
Ambient temp:	-20 °C to 45 °C
Class:	II

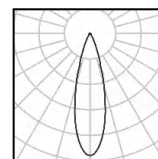

25W Ra92 3000K 24°

h(m)	E lx	D(m)
0.5	12084	0.25
1.0	3021	0.50
1.5	1343	0.75
2.0	755	1.00
2.5	483	1.25
3.0	336	1.50

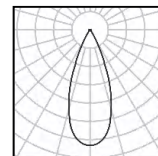

25W Ra92 3000K 38°

h(m)	E lx	D(m)
0.5	10063	0.31
1.0	2516	0.61
1.5	1118	0.92
2.0	629	1.22
2.5	403	1.53
3.0	280	1.83

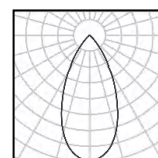

25W Ra92 3000K 50°

h(m)	E lx	D(m)
0.5	5483	0.46
1.0	1371	0.92
1.5	609	1.38
2.0	343	1.84
2.5	219	2.30
3.0	152	2.76



W system	lm system	optics	code
20W	1636	12°	SFL1020W-30N12-B
20W	1656	24°	SFL1020W-30N24-B
20W	1584	38°	SFL1020W-30N38-B
20W	1672	50°	SFL1020W-30N50-B



W system	lm system	optics	code
25W	1889	12°	SFL1025W-30N12-B
25W	1883	24°	SFL1025W-30N24-B
25W	1917	38°	SFL1025W-30N38-B
25W	1842	50°	SFL1025W-30N50-B

RING

Surface Light Circle



Fixed

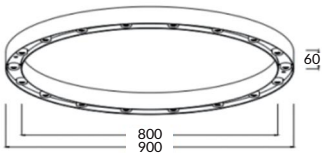
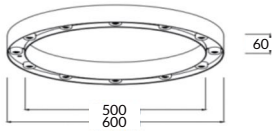
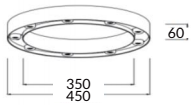

IP Rating:	IP20
Optics:	24°
UGR:	<10
CRI:	92Ra
Lifetime:	>50,000 hrs (L70 B10)
CCT:	3000K
Typical Source Efficacy (lm/W):	103
Control:	On/off, Mains Dim, 0/1-10V, Dali, Zigbee, Casambi
Binning	2 Step MacAdams
Input:	AC220-240V 50/60Hz
Output:	DC9-20V 600mA x 2 18W DC9-20V 600mA x 3 24W DC9-20V 600mA x 3 36W
Ambient temp:	-20 °C to 45 °C
Class:	II

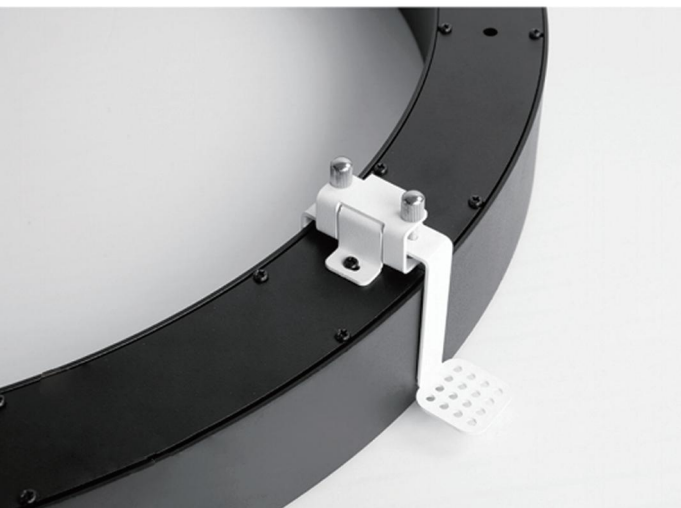

W system	lm system	optics	size	code
18W	900	24°	450mm	LCS45018W



W system	lm system	optics	size	code
24W	1200	24°	600mm	LCS60024W



W system	lm system	optics	size	code
36W	1800	24°	900mm	LCS90036W

CUPOLA

Φ114 Surface Downlight



view on website



Fixed



Ø114mm



White Painted



Black Painted

IP Rating:	IP20
Optics:	10°/24°/36°/55°
UGR:	<10
CRI:	98Ra
Lifetime:	>50,000 hrs (L70 B10)
CCT:	2700K/3000K
Typical Source	
Efficacy (lm/W):	110
Control:	On/off, Mains Dim, 0/1-10V, Dali, Zigbee, Casambi
Binning	2 Step MacAdams
Input:	AC220-240V 50/60Hz
Output:	DC 36V 150mA 6W DC 36V 200mA 8W
Ambient temp:	-20 C to 45 C
Class:	II



DuraGreen project:
Beijing Showroom



W system	lm system	optics	code
6W	376	10°	CUSSE11406W-30N10-W
6W	597	24°	CUSSE11406W-30N24-W
6W	590	36°	CUSSE11406W-30N36-W
6W	545	55°	CUSSE11406W-30N55-W



W system	lm system	optics	code
8W	445	10°	CUSSE11408W-30N10-W
8W	738	24°	CUSSE11408W-30N24-W
8W	736	36°	CUSSE11408W-30N36-W
8W	672	55°	CUSSE11408W-30N55-W

SUSPENSION

ACME / EVOLINE / BELLA / GLAMO / ORBIT /

BOLUX / CAPRI / HALO / CONVEX / RING /



view on website

Φ50 Engine Pendant



Fixed Optic

Engine

 Black

Glass

 Smoke Grey

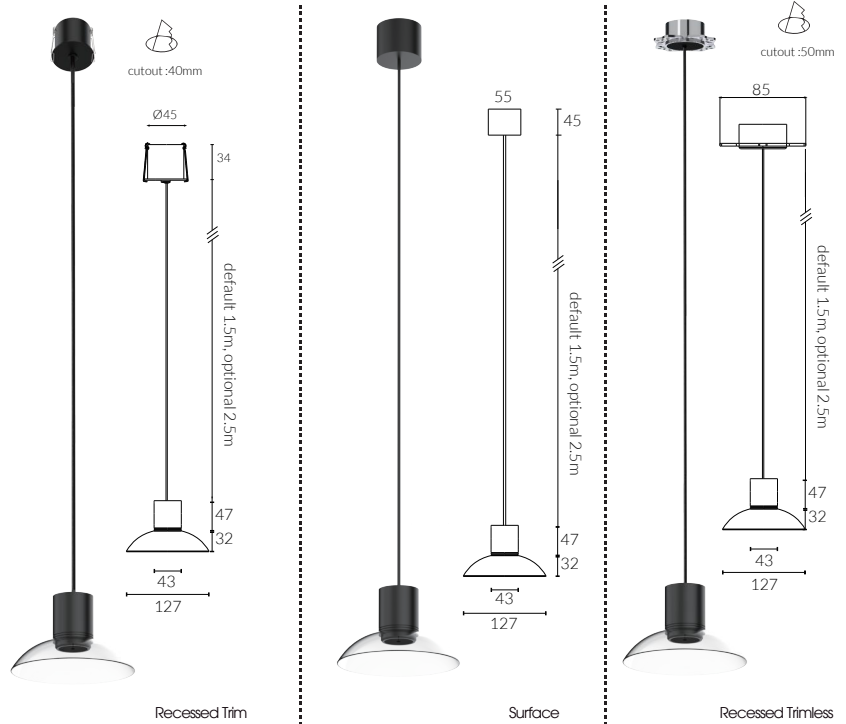

IP Rating: IP20 and IP44 options
Optics: 15°/24°/36°
UGR: <10
CRI: 98Ra
Lifetime: >50,000 hrs (L70 B10)
CCT: 2700K/3000K/3500K/4000K/5000K/
 2000K-3000K/1800K-4000K/2700K-6000K

Typical Source
Efficacy (lm/W): 110
Control: On/off, Mains Dim, 0/1-10V, Dali, Zigbee, Casambi
Binning 2 Step MacAdams
Input: AC220-240V 50/60Hz
Output: DC 36V 200mA 8W
Ambient temp: -20 °C to 45 °C
Class: II
Optional accessories: Honeycomb louvre, Solite Lense, Spread Lense, Colour Filter
Material: Fine aluminium 6063A, Glass

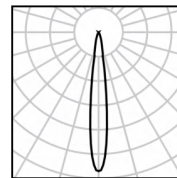

8W Ra98 3000K 15°

h(m)	E(lx)	D(m)
0.5	7204	0.11
1.0	1801	0.22
1.5	800	0.33
2.0	450	0.43
2.5	288	0.54
3.0	200	0.65

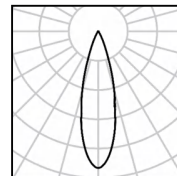

8W Ra98 3000K 24°

h(m)	E(lx)	D(m)
0.5	2613	0.25
1.0	653	0.49
1.5	290	0.74
2.0	163	0.99
2.5	105	1.24
3.0	73	1.48

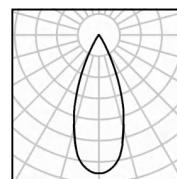

8W Ra98 3000K 36°

h(m)	E(lx)	D(m)
0.5	2005	0.34
1.0	501	0.68
1.5	223	1.03
2.0	125	1.37
2.5	80	1.71
3.0	56	2.05

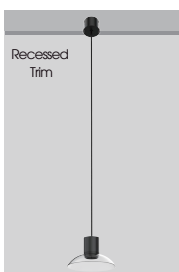

W system	lm system	optics	code
8W	336	15°	RTPGE5008W-30N15-B
8W	381	24°	RTPGE5008W-30N24-B
8W	453	36°	RTPGE5008W-30N36-B

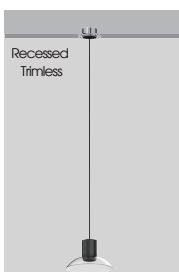

W system	lm system	optics	code
8W	336	15°	TLPGE5008W-30N15-B
8W	381	24°	TLPGE5008W-30N24-B
8W	453	36°	TLPGE5008W-30N36-B

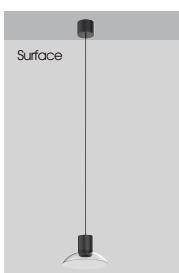

W system	lm system	optics	code
8W	336	15°	STPGE5008W-30N15-B
8W	381	24°	STPGE5008W-30N24-B
8W	453	36°	STPGE5008W-30N36-B



view on website

Φ57 Engine Pendant



Fixed Optic

○ White Painted

● Black Painted

● Antique Bronze

● Brushed Grey

● Solid Brass

● Faceted Brass

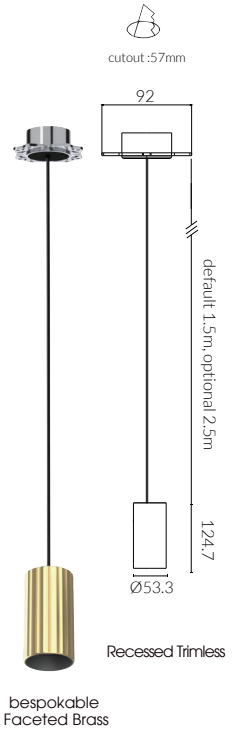
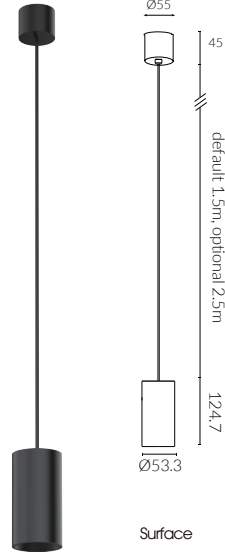
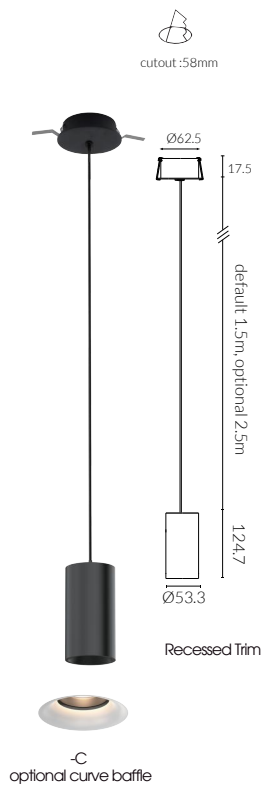

IP Rating: IP20 and IP44 options
Optics: 15°/24°/36°
UGR: <10
CRI: 98Ra
Lifetime: >50,000 hrs (L70 B10)
CCT: 2700K/3000K/3500K/4000K/5000K/
 2000K-3000K/1800K-4000K/2700K-6000K

Typical Source
Efficacy (lm/W): 110
Control: On/off, Mains Dim, 0/1-10V, Dali, Zigbee, Casambi
Binning 2 Step MacAdams
Input: AC220-240V 50/60Hz
Output: DC 36V 250mA 10W
Ambient temp: -20 °C to 45 °C
Class: II
Optional accessories: Honeycomb louvre, Solite Lens, Spread Lens, Colour Filter
Material: Fine aluminium 6063A

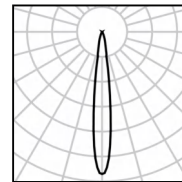

10W Ra98 3000K 15°

h(m)	E(lx)	D(m)
0.5	10728	0.15
1.0	2682	0.31
1.5	1192	0.46
2.0	671	0.61
2.5	429	0.77
3.0	298	0.92

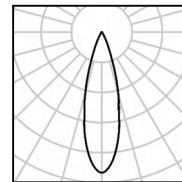

10W Ra98 3000K 24°

h(m)	E(lx)	D(m)
0.5	7580	0.21
1.0	1895	0.42
1.5	842	0.63
2.0	474	0.84
2.5	303	1.04
3.0	211	1.25

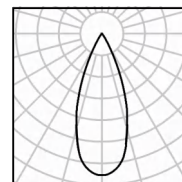

10W Ra98 3000K 36°

h(m)	E(lx)	D(m)
0.5	4206	0.28
1.0	1051	0.57
1.5	467	0.85
2.0	263	1.14
2.5	168	1.42
3.0	117	1.71

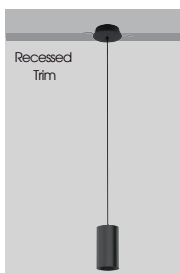

W system	lm system	optics	code
10W	462	15°	RTPE5710W-30N15-B
10W	628	24°	RTPE5710W-30N24-B
10W	616	36°	RTPE5710W-30N36-B



W system	lm system	optics	code
10W	462	15°	TLPE5710W-30N15-B
10W	628	24°	TLPE5710W-30N24-B
10W	616	36°	TLPE5710W-30N36-B

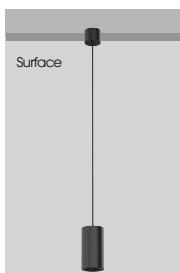

W system	lm system	optics	code
10W	462	15°	STPE5710W-30N15-B
10W	628	24°	STPE5710W-30N24-B
10W	616	36°	STPE5710W-30N36-B



view on website

Φ68 Engine Pendant

-  White Painted
-  Black Painted
-  Antique Bronze
-  Brushed Grey

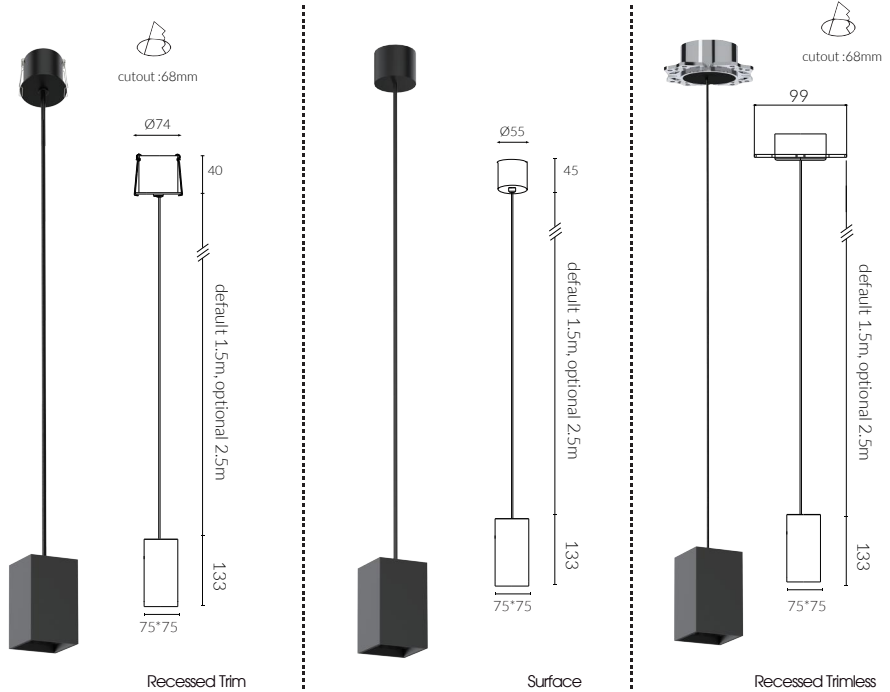

IP Rating: IP20 and IP44 options
Optics: 15°/24°/36°/50°
UGR: <10
CRI: 98Ra
Lifetime: >50,000 hrs (L70 B10)
CCT: 2700K/3000K/3500K/4000K/5000K/
2000K-3000K/1800K-4000K/2700K-6000K

Typical Source
Efficacy (lm/W): 110
Control: On/off, Mains Dim, 0/1-10V, Dali, Zigbee, Casambi
Binning 2 Step MacAdams
Input: AC220-240V 50/60Hz
Output: DC 36V 250mA 10W
DC 36V 300mA 12W
Ambient temp: -20 °C to 45 °C
Class: II
Optional accessories: Honeycomb louvre, Solite Lense, Spread Lense, Colour Filter
Material: Fine aluminium 6063A

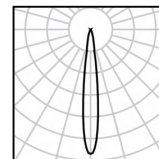

12W Ra98 3000K 15°

h(m)	E(lx)	D(m)
0.5	10897	0.17
1.0	2724	0.33
1.5	1211	0.50
2.0	681	0.66
2.5	436	0.83
3.0	303	0.99

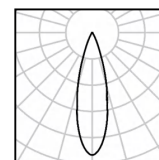

12W Ra98 3000K 24°

h(m)	E(lx)	D(m)
0.5	8621	0.20
1.0	2155	0.41
1.5	958	0.61
2.0	539	0.81
2.5	345	1.02
3.0	239	1.22

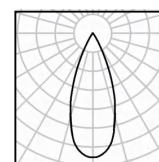

12W Ra98 3000K 36°

h(m)	E(lx)	D(m)
0.5	4792	0.28
1.0	1198	0.55
1.5	532	0.83
2.0	300	1.10
2.5	192	1.38
3.0	133	1.65

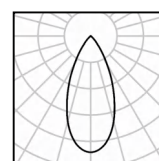

12W Ra98 3000K 50°

h(m)	E(lx)	D(m)
0.5	1608	0.47
1.0	402	0.93
1.5	179	1.40
2.0	100	1.87
2.5	64	2.33
3.0	45	2.80



W system	lm system	optics	code
12W	717	15°	RTPQE6812W-30N15-B
12W	760	24°	RTPQE6812W-30N24-B
12W	750	36°	RTPQE6812W-30N36-B
12W	640	50°	RTPQE6812W-30N50-B

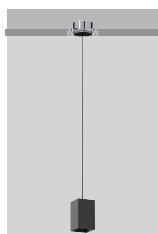

W system	lm system	optics	code
12W	717	15°	TLPQE6812W-30N15-B
12W	760	24°	TLPQE6812W-30N24-B
12W	750	36°	TLPQE6812W-30N36-B
12W	640	50°	TLPQE6812W-30N50-B

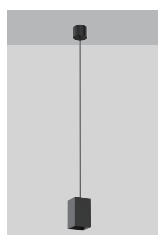

W system	lm system	optics	code
12W	717	15°	STPQE6812W-30N15-B
12W	760	24°	STPQE6812W-30N24-B
12W	750	36°	STPQE6812W-30N36-B
12W	640	50°	STPQE6812W-30N50-B



view on website

Φ68 Engine Pendant



Fixed Optic

Engine



Black

Glass



Smoke grey

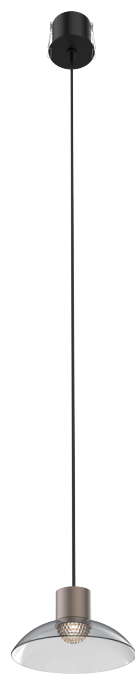

bespoke 340° omnidirectional



Recessed Trim



Surface

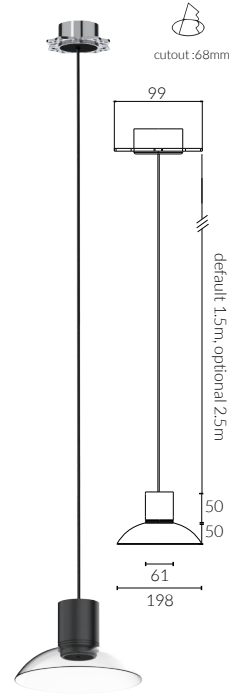
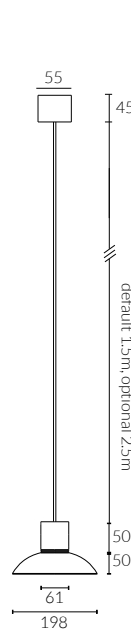

Recessed Trimless



- IP Rating:** IP20 and IP44 options
- Optics:** 15°/24°/36°/50°/340°
- UGR:** <10
- CRI:** 98Ra
- Lifetime:** >50,000 hrs (L70 B10)
- CCT:** 2700K/3000K/3500K/4000K/5000K/
2000K-3000K/1800K-4000K/2700K-6000K

- Typical Source Efficacy (lm/W):** 110
- Control:** On/off, Mains Dim, 0/1-10V, Dali, Zigbee, Casambi
- Binning:** 2 Step MacAdams
- Input:** AC220-240V 50/60Hz
DC 36V 250mA 10W
- Output:** DC 36V 300mA 12W
- Ambient temp:** -20 °C to 45 °C
- Class:** II
- Optional accessories:** Honeycomb louvre, Solite Lens, Spread Lens, Colour Filter
- Material:** Fine aluminium 6063A, Glass

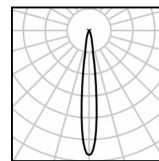

12W Ra98 3000K 15°

h(m)	E(lx)	D(m)
0.5	10897	0.17
1.0	2724	0.33
1.5	1211	0.50
2.0	681	0.66
2.5	436	0.83
3.0	303	0.99

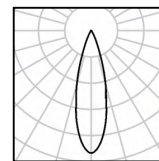

12W Ra98 3000K 24°

h(m)	E(lx)	D(m)
0.5	8621	0.20
1.0	2155	0.41
1.5	958	0.61
2.0	539	0.81
2.5	345	1.02
3.0	239	1.22

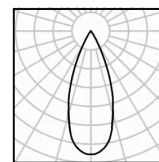

12W Ra98 3000K 36°

h(m)	E(lx)	D(m)
0.5	4792	0.28
1.0	1198	0.55
1.5	532	0.83
2.0	300	1.10
2.5	192	1.38
3.0	133	1.65

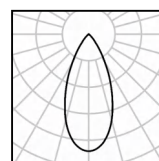

12W Ra98 3000K 50°

h(m)	E(lx)	D(m)
0.5	1608	0.47
1.0	402	0.93
1.5	179	1.40
2.0	100	1.87
2.5	64	2.33
3.0	45	2.80

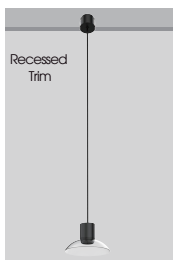

W system	lm system	optics	code
12W	717	15°	RTPGE6812W-30N15-B
12W	760	24°	RTPGE6812W-30N24-B
12W	750	36°	RTPGE6812W-30N36-B
12W	640	50°	RTPGE6812W-30N50-B
12W	650	340°	RTPGE6812W-30N340-B



W system	lm system	optics	code
12W	717	15°	TLPGE6812W-30N15-B
12W	760	24°	TLPGE6812W-30N24-B
12W	750	36°	TLPGE6812W-30N36-B
12W	640	50°	TLPGE6812W-30N50-B
12W	650	340°	TLPGE6812W-30N340-B

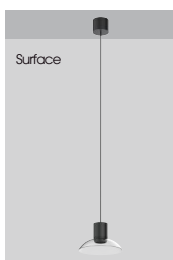

W system	lm system	optics	code
12W	717	15°	STPGE6812W-30N15-B
12W	760	24°	STPGE6812W-30N24-B
12W	750	36°	STPGE6812W-30N36-B
12W	640	50°	STPGE6812W-30N50-B
12W	650	340°	STPGE6812W-30N340-B

EVOLINE



view on website

67X64 Square Pendant



Fixed Optic

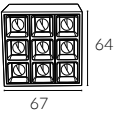

Bezel

 matt white painted

 matt black painted

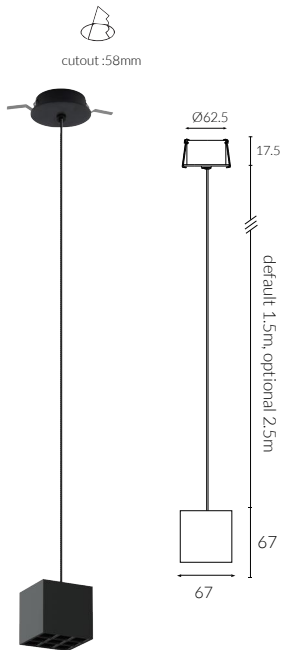

Recessed Trim

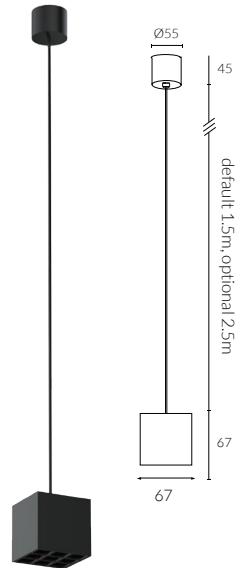

Surface

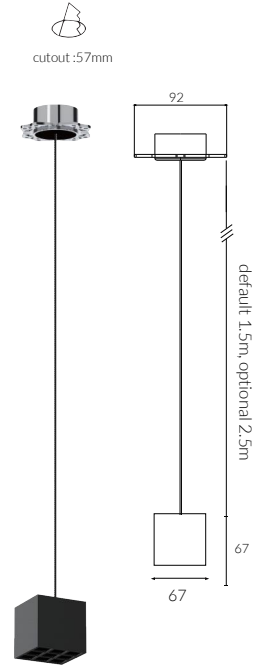

Recessed Trimless

- IP Rating:** IP20
- Optics:** 50°
- UGR:** <17
- CRI:** 92Ra
- Lifetime:** >50,000 hrs (L70 B10)
- CCT:** 3000K/3500K
- Typical Source**
- Efficacy (lm/W):** 113
- Control:** On/off, Mains Dim, 0/1-10V, Dali, Zigbee, Casambi
- Binning** 2 Step MacAdams
- Input:** AC220-240V 50/60Hz
- Output:** DC 27V 300mA 8W
- Ambient temp:** -20 C to 45 C
- Class:** II
- Material:** Fine aluminium 6063A

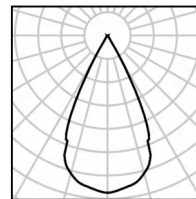

8W Ra92 3000K 50°

h(m)	E(lx)	D(m)
0.5	907	0.48
1.0	227	0.96
1.5	101	1.44
2.0	57	1.93
2.5	36	2.41
3.0	25	2.89

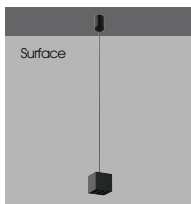
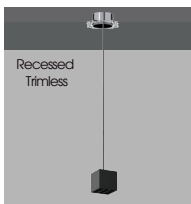
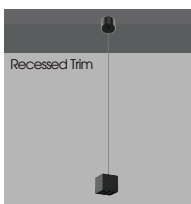

W system	lm system	optics	code
8W	458	50°	RTPQ0908W-30N50

W system	lm system	optics	code
8W	458	50°	TLPQ0908W-30N50

W system	lm system	optics	code
8W	458	50°	STPQ0908W-30N50

EVOLINE



view on website

L1124 Surface Pendant



Fixed

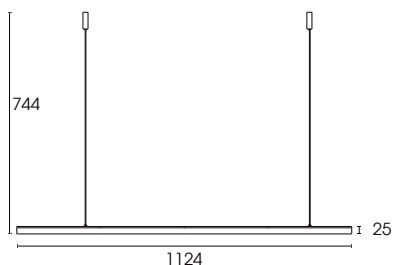

White Painted



Black Painted

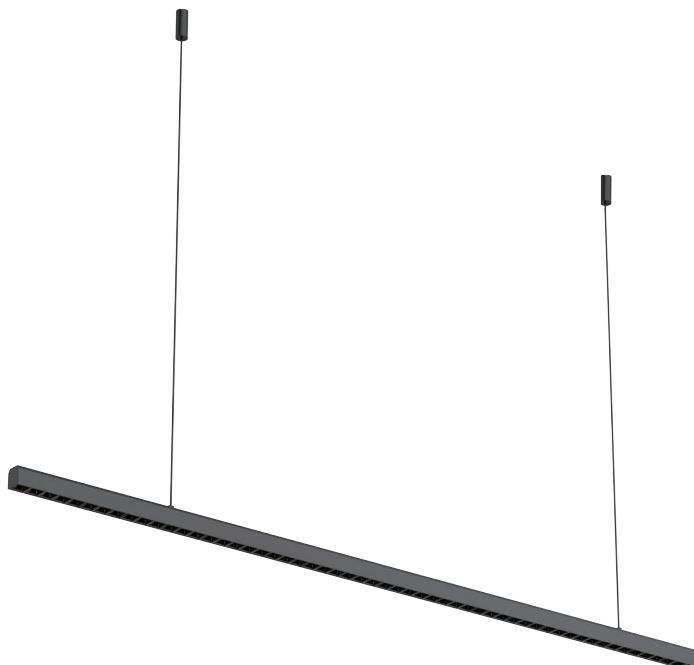

- IP Rating:** IP20
- Optics:** 30°/55°/65°/65°Extra Wide/Forward throwing
- UGR:** <17
- CRI:** 92Ra
- Lifetime:** >50,000 hrs (L70 B10)
- CCT:** 3000K/4000K
- Typical Source Efficacy (lm/W):** 113
- Control:** On/off, Mains Dim, 0/1-10V, Dali, Zigbee, Casambi
- Binning:** 2 Step MacAdams
- Voltage:** DC 24V
- Power(W):** 21W
- Ambient temp:** -20 C to 45 C
- Material:** Fine aluminium 6063A
- Class:** II

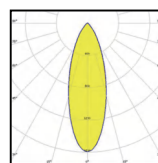

30°

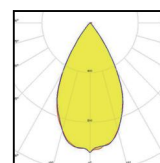

55°

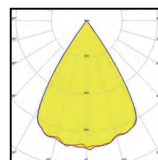

65°

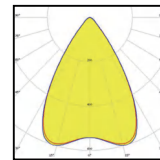

65° Extra Wide

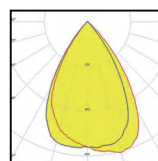

Forward throwing

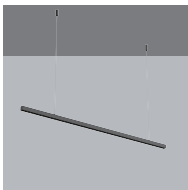

W system	lm system	optics	code
21W	1624	30°	STPL5421W-30N30
21W	1533	55°	STPL5421W-30N55
21W	1624	65°	STPL5421W-30N65
21W	1533	65°Extra Wide°	STPL5421W-30N65E
21W	1456	Forward throwing	STPL5421W-30NFT

BELLA



view on website

Φ41 Zoomable 20°-50° Pendant

-  White Painted
-  Black Painted
-  Antique Bronze
-  Brushed Grey

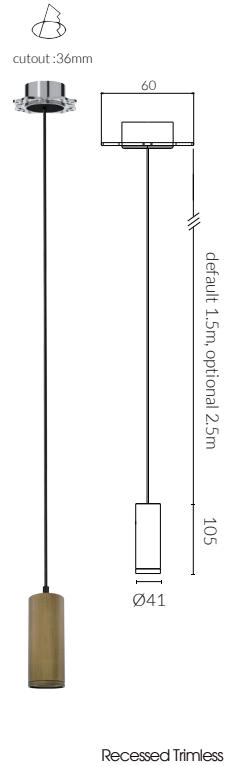
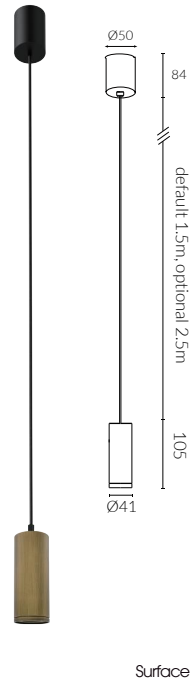
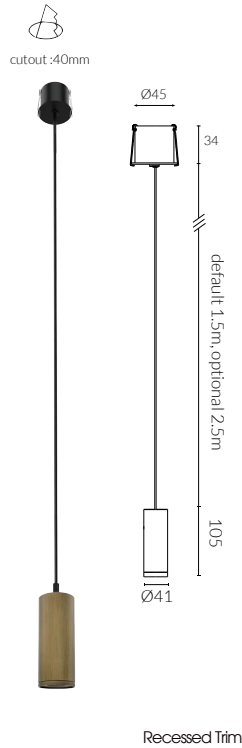

- IP Rating:** IP20
- Optics:** Zoomable 20°-50°
- UGR:** <17
- CRI:** 92Ra
- Lifetime:** >50,000 hrs (L70 B10)
- CCT:** 3000K/3500K/2700-6000K
- Typical Source Efficacy (lm/W):** 96
- Control:** On/off, Mains Dim, 0/1-10V, Dali, Zigbee, Casambi
- Binning:** 2 Step MacAdams
- Input:** AC220-240V 50/60Hz
- Output:** DC 12V 600mA 8W
- Ambient temp:** -20 °C to 45 °C
- Class:** II
- Material:** Fine aluminium 6063A

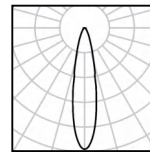

8W Ra92 3000K 20°

h(m)	E(lx)	D(m)
0.5	2978	0.21
1.0	745	0.42
1.5	331	0.63
2.0	186	0.84
2.5	119	1.04
3.0	83	1.25

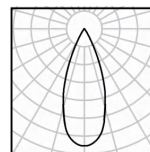

8W Ra92 3000K 30°

h(m)	E(lx)	D(m)
0.5	1805	0.30
1.0	451	0.59
1.5	201	0.89
2.0	113	1.18
2.5	72	1.48
3.0	50	1.78

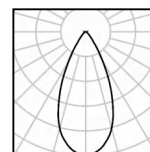

8W Ra92 3000K 50°

h(m)	E(lx)	D(m)
0.5	795	0.49
1.0	199	0.97
1.5	88	1.46
2.0	50	1.94
2.5	32	2.43
3.0	22	2.91

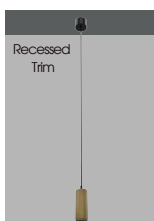
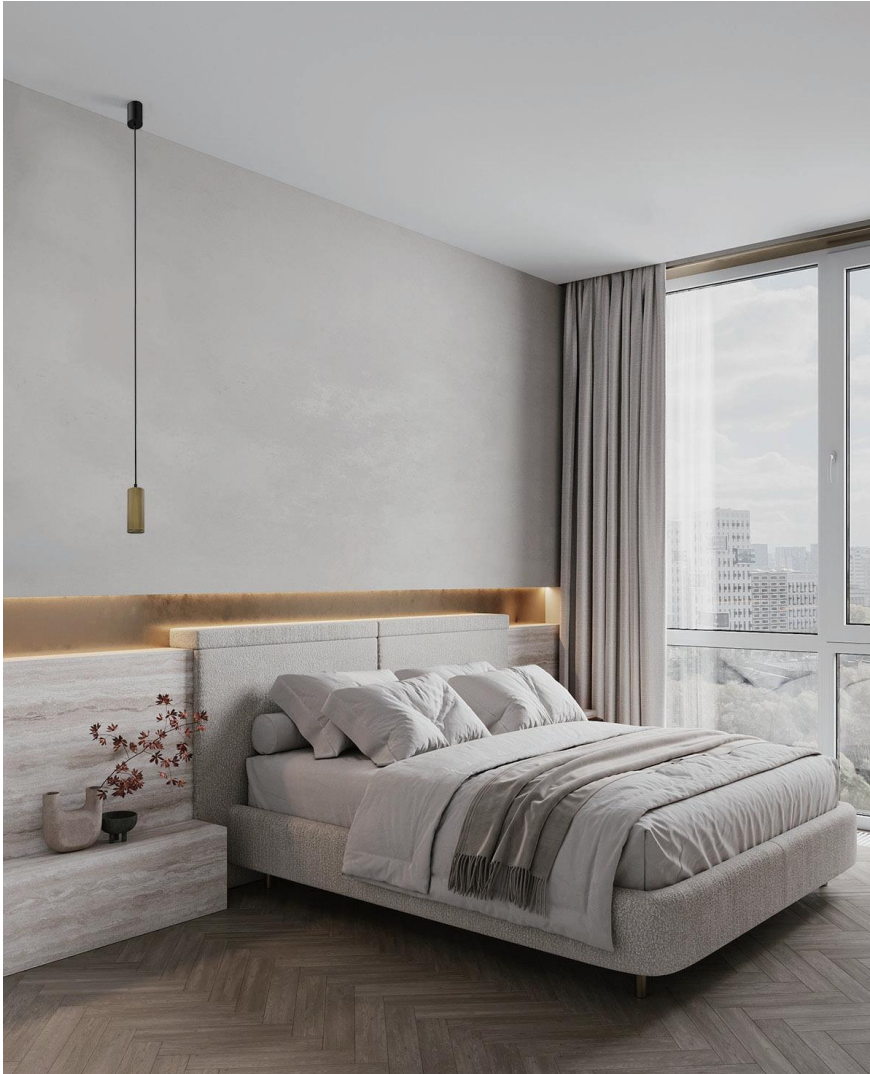

W system	lm system	optics	code
8W	388-385	20°- 50°	RTP4108W-30N2050-B

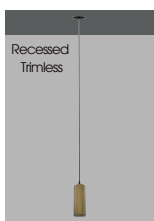

W system	lm system	optics	code
8W	388-385	20°- 50°	TLP4108W-30N2050-B

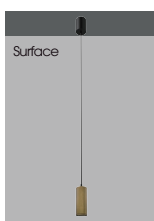

W system	lm system	optics	code
8W	388-385	20°- 50°	STP4108W-30N2050-B

BELLA



view on website

Φ41 Zoomable 20°-50° Pendant Wall Fixtures/Ceilings

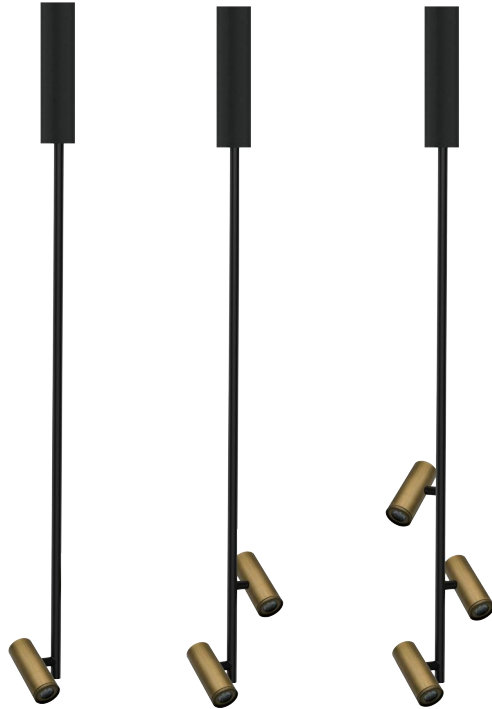
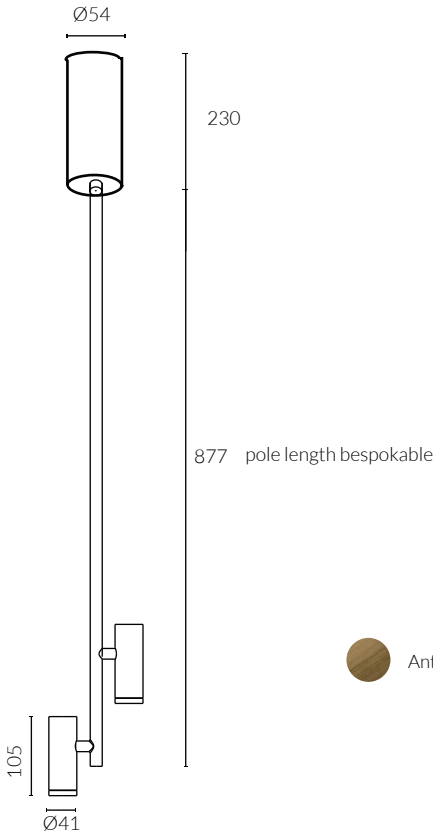

- IP Rating:** IP20
- Optics:** Zoomable 20°-50°
- UGR:** <17
- CRI:** 92Ra
- Lifetime:** >50,000 hrs (L70 B10)
- CCT:** 3000K/3500K/2700-6000K
- Typical Source**
- Efficacy (lm/W):** 96
- Control:** On/off
- Binning** 2 Step MacAdams
- Input:** 48VDC
- Output:** 12V 400mA 6W
- Ambient temp:** -20 °C to 45 °C
- Class:** II
- Material:** Fine aluminium 6063A

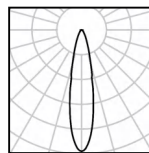

8W Ra92 3000K 20°

h(m)	E(lx)	D(m)
0.5	2978	0.21
1.0	745	0.42
1.5	331	0.63
2.0	186	0.84
2.5	119	1.04
3.0	83	1.25

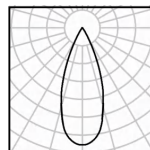

8W Ra92 3000K 30°

h(m)	E(lx)	D(m)
0.5	1805	0.30
1.0	451	0.59
1.5	201	0.89
2.0	113	1.18
2.5	72	1.48
3.0	50	1.78

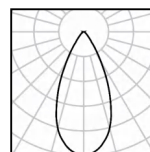

8W Ra92 3000K 50°

h(m)	E(lx)	D(m)
0.5	795	0.49
1.0	199	0.97
1.5	88	1.46
2.0	50	1.94
2.5	32	2.43
3.0	22	2.91

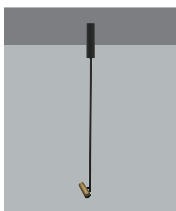

W system	Spots	lm system	optics	code
6W	1 Spot	292- 296	20°- 50°	SP14106WX1-30N2050-AB

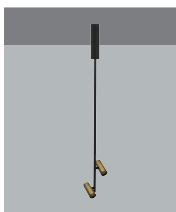

W system	Spots	lm system	optics	code
6W*2	2 Spot	296*2-296*2	20°- 50°	SP24106WX2-30N2050-AB

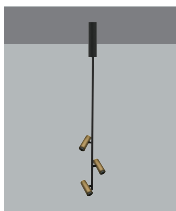

W system	Spots	lm system	optics	code
6W*3	3 Spot	296*3-296*3	20°- 50°	SP34106WX3-30N2050-AB



view on website

Φ68 Zoomable 15°-50° Spotlight

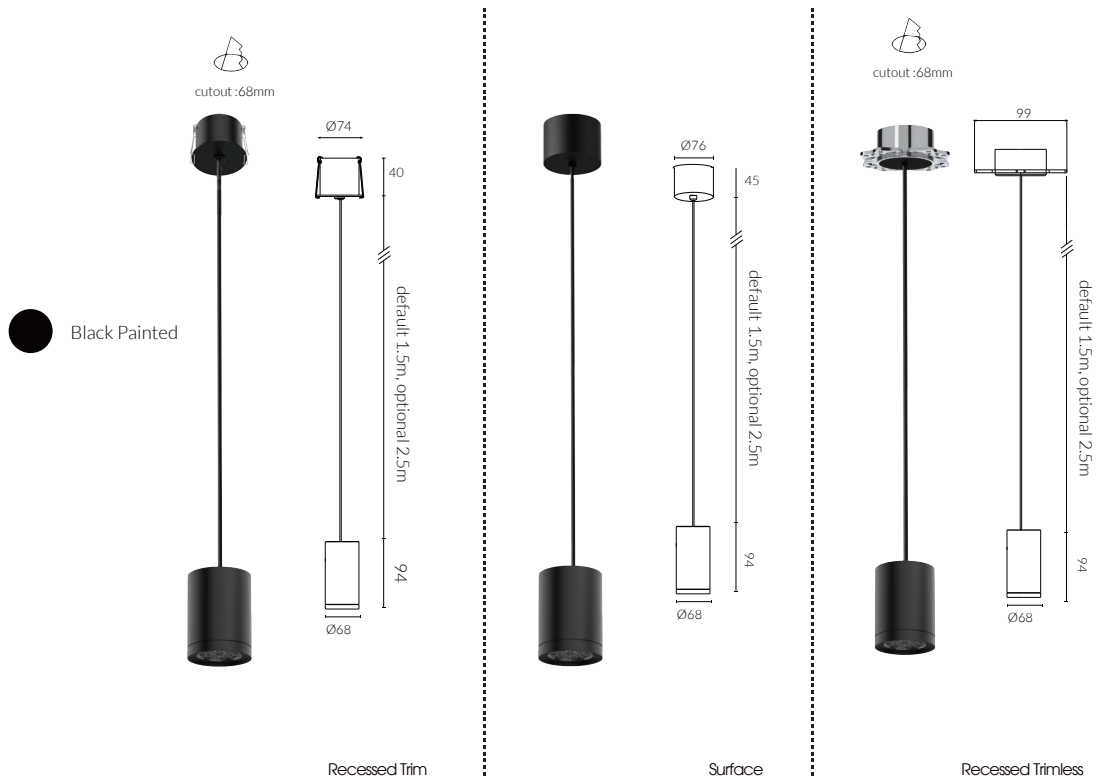

IP Rating: IP20
Optics: Zoomable 15°-50°
UGR: <17
CRI: 98Ra
Lifetime: >50,000 hrs (L70 B10)
CCT: 2700K/3000K/3500K/4000K/5000K/
 2000K-3000K/1800K-4000K/2700K-6000K

Typical Source Efficacy (lm/W): 110
Control: On/off, Mains Dim, 0/1-10V, Dali, Zigbee, Casambi
Binning: 2 Step MacAdams
Input: AC220-240V 50/60Hz
Output: DC 36V 300mA 12W
Ambient temp: -20 C to 45 C
Class: II
Material: Fine aluminium 6063A

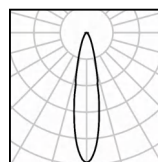

12W Ra98 3000K 15°

h(m)	E(lx)	D(m)
0.5	12099	0.14
1.0	3025	0.27
1.5	1344	0.41
2.0	756	0.54
2.5	484	0.68
3.0	336	0.81

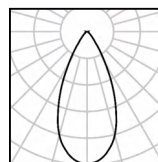

12W Ra98 3000K 40°

h(m)	E(lx)	D(m)
0.5	2174	0.38
1.0	544	0.76
1.5	242	1.14
2.0	136	1.52
2.5	87	1.90
3.0	60	2.28



W system	lm system	optics	code
12W	756-747	15°- 50°	RTP6812W-30N1550-B



W system	lm system	optics	code
12W	756-747	15°- 50°	TLP6812W-30N1550-B

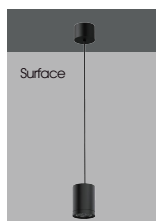

W system	lm system	optics	code
12W	756-747	15°- 50°	STP6812W-30N1550-B

ORBIT

Φ30 Surface Pendant



Fixed Optic

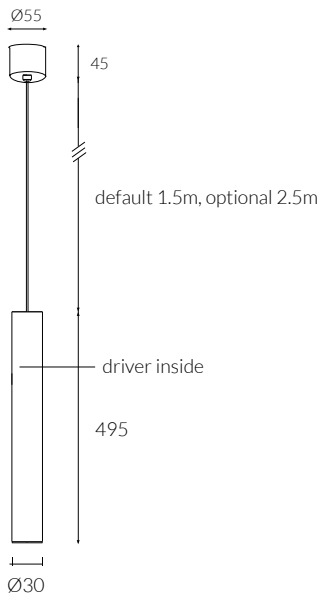

view on website

-  White Painted
-  Black Painted

- IP Rating:** IP20
- Optics:** 15°/25°/30°/50°
- UGR:** < 10
- CRI:** 92Ra
- Lifetime:** >50,000 hrs (L70 B10)
- CCT:** 2700K/3000K
- Typical Source Efficacy (lm/W):** 113
- Control:** On/off, Mains Dim, 0/1-10V, Dali, Zigbee, Casambi
- Binning:** 2 Step MacAdams
- Input:** AC220-240V 50/60Hz
- Output:** DC 3V 300mA 1.3W
DC 3V 650mA 3W
- Ambient temp:** -20 °C to 45 °C
- Class:** II

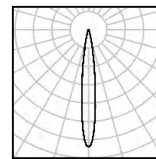

3W Ra92 3000K 15°

h(m)	E(lx)	D(m)
0.5	4168	0.11
1.0	1042	0.23
1.5	463	0.34
2.0	261	0.46
2.5	167	0.57
3.0	116	0.65

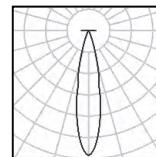

3W Ra92 3000K 25°

h(m)	E(lx)	D(m)
0.5	1872	0.18
1.0	468	0.36
1.5	208	0.55
2.0	117	0.73
2.5	75	0.91
3.0	52	1.09

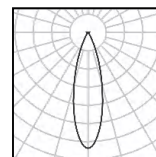

3W Ra92 3000K 30°

h(m)	E(lx)	D(m)
0.5	855	0.25
1.0	214	0.50
1.5	95	0.75
2.0	53	1.00
2.5	34	1.26
3.0	24	1.51

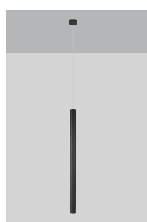

W system	lm system	optics	code
1.3W	68	15°	MFP301.3W-30N15-W
1.3W	79	25°	MFP301.3W-30N25-W
1.3W	85	30°	MFP301.3W-30N30-W
1.3W	82	50°	MFP301.3W-30N50-W

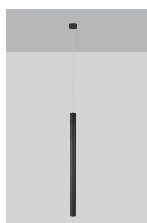

W system	lm system	optics	code
3W	148	15°	MFP3003W-30N15-W
3W	157	25°	MFP3003W-30N25-W
3W	179	30°	MFP3003W-30N30-W
3W	162	50°	MFP3003W-30N50-W

ORBIT

Φ55 Surface Pendant



Fixed Optic

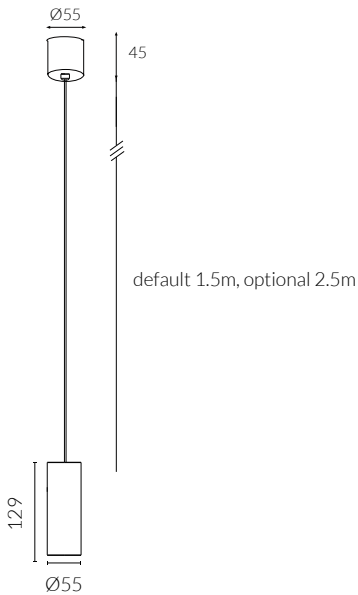

view on website

-  White Painted
-  Black Painted

- IP Rating:** IP20
- Optics:** 12°/20°/30°/40°
- UGR:** <10
- CRI:** 98Ra
- Lifetime:** >50,000 hrs (L70 B10)
- CCT:** 2700K/3000K
- Typical Source**
- Efficacy (lm/W):** 110
- Control:** On/off, Mains Dim, 0/1-10V, Dali, Zigbee, Casambi
- Binning** 2 Step MacAdams
- Input:** AC220-240V 50/60Hz
- Output:** DC 36V 250mA 10W
DC 36V 300mA 12W
DC 36V 350mA 15W
- Ambient temp:** -20 C to 45 C
- Class:** II

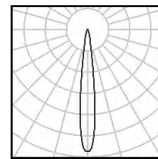

15W Ra98 3000K 12°

h(m)	E(lx)	D(m)
0.5	19862	0.11
1.0	4965	0.22
1.5	2207	0.33
2.0	1241	0.43
2.5	794	0.54
3.0	552	0.65

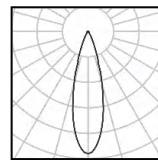

15W Ra98 3000K 20°

h(m)	E(lx)	D(m)
0.5	11574	0.18
1.0	2894	0.36
1.5	1286	0.54
2.0	723	0.72
2.5	463	0.90
3.0	322	1.08

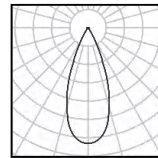

15W Ra98 3000K 30°

h(m)	E(lx)	D(m)
0.5	6165	0.27
1.0	1541	0.54
1.5	685	0.80
2.0	385	1.07
2.5	247	1.34
3.0	171	1.61

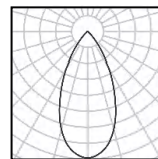

15W Ra98 3000K 40°

h(m)	E(lx)	D(m)
0.5	2648	0.38
1.0	662	0.76
1.5	294	1.15
2.0	166	1.53
2.5	106	1.91
3.0	74	2.29

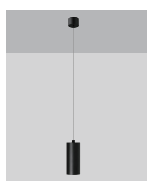

W system	lm system	optics	code
10W	639	12°	MFP5510W-30N12-B
10W	684	20°	MFP5510W-30N20-B
10W	738	30°	MFP5510W-30N30-B
10W	700	40°	MFP5510W-30N40-B

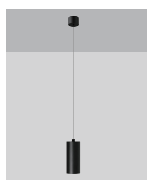

W system	lm system	optics	code
12W	747	12°	MFP5512W-30N12-B
12W	749	20°	MFP5512W-30N20-B
12W	803	30°	MFP5512W-30N30-B
12W	760	40°	MFP5512W-30N40-B



W system	lm system	optics	code
15W	808	12°	MFP5515W-30N12-B
15W	896	20°	MFP5515W-30N20-B
15W	956	30°	MFP5515W-30N30-B
15W	906	40°	MFP5515W-30N40-B

ORBIT

Φ75 Surface Pendant



Fixed Optic

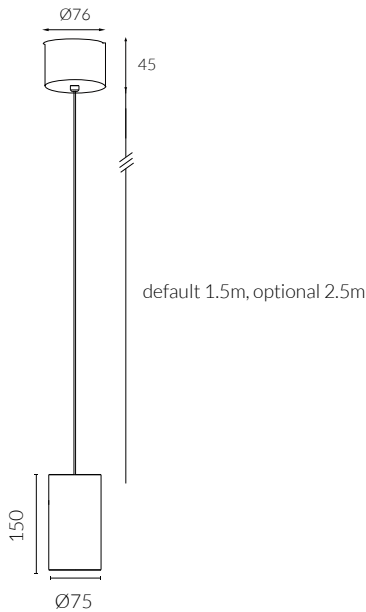

view on website



-  White Painted
-  Black Painted

- IP Rating:** IP20
- Optics:** 15°/24°/36°/55°
- UGR:** <10
- CRI:** 98Ra
- Lifetime:** >50,000 hrs (L70 B10)
- CCT:** 2700K/3000K
- Typical Source Efficacy (lm/W):** 110
- Control:** On/off, Mains Dim, 0/1-10V, Dali, Zigbee, Casambi
- Binning:** 2 Step MacAdams
- Input:** AC220-240V 50/60Hz
- Output:** DC 36V 500mA 20W
DC 36V 600mA 25W
DC 36V 700mA 30W
- Ambient temp:** -20 °C to 45 °C
- Class:** II

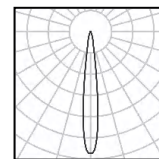

30W Ra98 3000K 15°

h(m)	E(lx)	D(m)
0.5	36897	0.12
1.0	9224	0.25
1.5	4100	0.37
2.0	2306	0.50
2.5	1476	0.62
3.0	1025	0.75

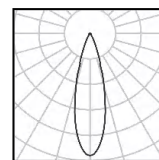

30W Ra98 3000K 24°

h(m)	E(lx)	D(m)
1.0	29283	0.18
2.0	7321	0.36
3.0	3254	0.53
4.0	1830	0.71
5.0	1171	0.89
6.0	813	1.07

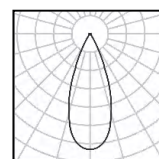

30W Ra98 3000K 36°

h(m)	E(lx)	D(m)
1.0	11973	0.32
2.0	2993	0.63
3.0	1330	0.95
4.0	748	1.26
5.0	479	1.58
6.0	333	1.89

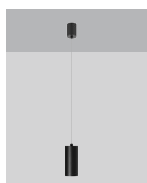

W system	lm system	optics	code
20W	1348	15°	MFP7520W-30N15-B
20W	1595	24°	MFP7520W-30N24-B
20W	1643	36°	MFP7520W-30N36-B
20W	1369	50°	MFP7520W-30N50-B

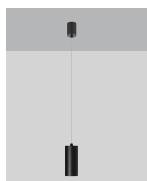

W system	lm system	optics	code
25W	1503	15°	MFP7525W-30N15-B
25W	1946	24°	MFP7525W-30N24-B
25W	1909	36°	MFP7525W-30N36-B
25W	1825	50°	MFP7525W-30N50-B

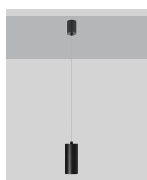

W system	lm system	optics	code
30W	1706	15°	MFP7530W-30N15-B
30W	2219	24°	MFP7530W-30N24-B
30W	2184	36°	MFP7530W-30N36-B
30W	1965	50°	MFP7530W-30N50-B

CUPOLA

Φ114 Bowl Pendant



view on website



Fixed Optic



Ceiling hook to move light point



White Painted

Black Painted



Recessed Trim

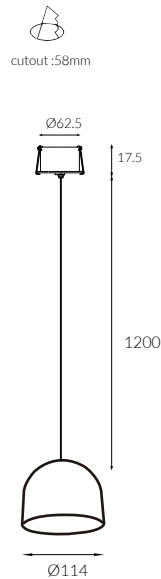

Surface

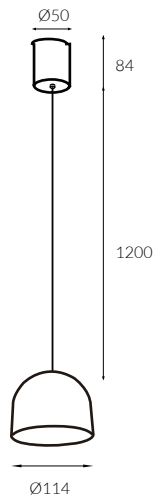

IP Rating:	IP20
Optics:	10°/24°/36°/55°
UGR:	< 10
CRI:	98Ra
Lifetime:	> 50,000 hrs (L70 B10)
CCT:	2700K/3000K/3500K/4000K/5000K/2000K-3000K/1800K-4000K/2700K-6500K
Typical Source Efficacy (lm/W):	110
Control:	On/off, Mains Dim, 0/1-10V, Dali, Zigbee, Casambi
Binning	2 Step MacAdams
Input:	AC220-240V 50/60Hz
Output:	DC 36V 150mA 6W DC 36V 200mA 8W
Ambient temp:	-20 C to 45 C
Class:	II

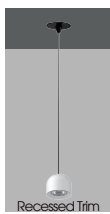

W system	lm system	optics	code
6W	376	10°	PURSE11406W-30N10-W
6W	597	24°	PURSE11406W-30N24-W
6W	590	36°	PURSE11406W-30N36-W
6W	545	55°	PURSE11406W-30N55-W

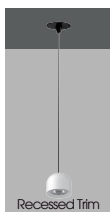

W system	lm system	optics	code
8W	445	10°	PURSE11408W-30N10-W
8W	738	24°	PURSE11408W-30N24-W
8W	736	36°	PURSE11408W-30N36-W
8W	672	55°	PURSE11408W-30N55-W



W system	lm system	optics	code
6W	376	10°	PUSSE11406W-30N10-B
6W	597	24°	PUSSE11406W-30N24-B
6W	590	36°	PUSSE11406W-30N36-B
6W	545	55°	PUSSE11406W-30N55-B



W system	lm system	optics	code
8W	445	10°	PUSSE11408W-30N10-B
8W	738	24°	PUSSE11408W-30N24-B
8W	736	36°	PUSSE11408W-30N36-B
8W	672	55°	PUSSE11408W-30N55-B

CAPRI

Φ114 Hat Pendant



view on website



Fixed Optic



Ceiling hook to move light point



White Painted



Black Painted

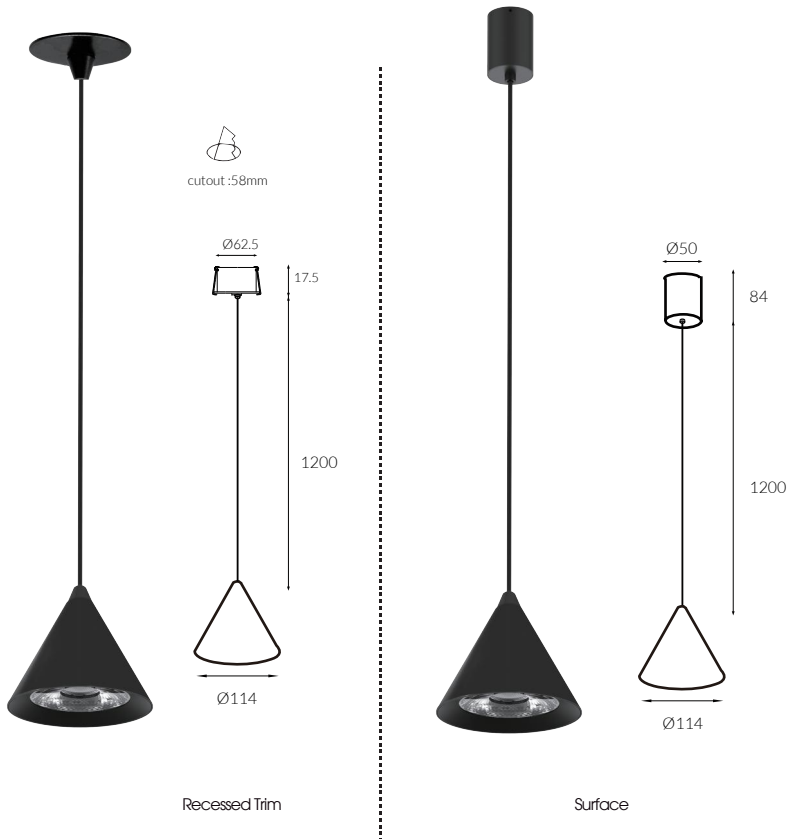

IP Rating:	IP20
Optics:	10°/24°/36°/55°
UGR:	< 10
CRI:	98Ra
Lifetime:	> 50,000 hrs (L70 B10)
CCT:	2700K/3000K/3500K/4000K/5000K/2000K-3000K/1800K-4000K/2700K-6500K
Typical Source	
Efficacy (lm/W):	110
Control:	On/off, Mains Dim, 0/1-10V, Dali, Zigbee, Casambi
Binning	2 Step MacAdams
Input:	AC220-240V 50/60Hz
Output:	DC 36V 150mA 6W DC 36V 200mA 8W
Ambient temp:	-20 C to 45 C
Class:	II

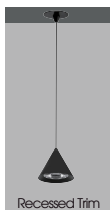

W system	lm system	optics	code
6W	376	10°	PJRT11406W-30N10-SG
6W	597	24°	PJRT11406W-30N24-SG
6W	590	36°	PJRT11406W-30N36-SG
6W	545	55°	PJRT11406W-30N55-SG

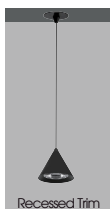

W system	lm system	optics	code
8W	445	10°	PJRT11408W-30N10-SG
8W	738	24°	PJRT11408W-30N24-SG
8W	736	36°	PJRT11408W-30N36-SG
8W	672	55°	PJRT11408W-30N55-SG



W system	lm system	optics	code
6W	376	10°	PJST11406W-30N10-SG
6W	597	24°	PJST11406W-30N24-SG
6W	590	36°	PJST11406W-30N36-SG
6W	545	55°	PJST11406W-30N55-SG



W system	lm system	optics	code
8W	445	10°	PJST11408W-30N10-SG
8W	738	24°	PJST11408W-30N24-SG
8W	736	36°	PJST11408W-30N36-SG
8W	672	55°	PJST11408W-30N55-SG

HALO

Φ50 Ball Pendant



view on website



Fixed Optic



Ceiling hook to move light point



Anodized Grey

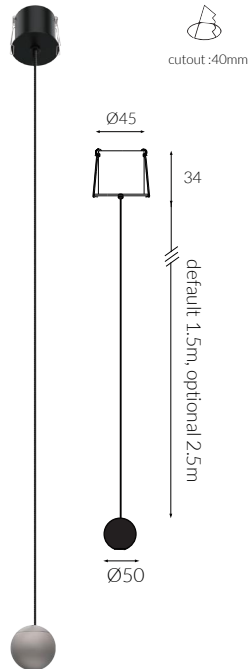

Recessed Trim

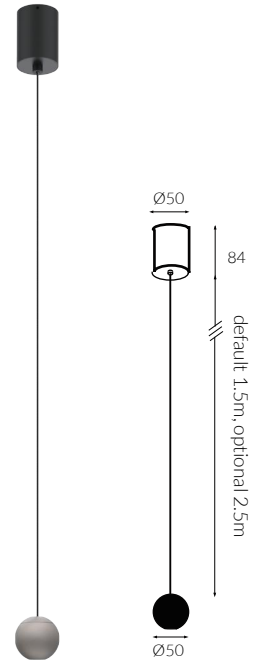

Surface

IP Rating:	IP20
Optics:	15°/25°/30°/50°/60°
UGR:	<10
CRI:	92Ra
Lifetime:	>50,000 hrs (L70 B10)
CCT:	3000K
Typical Source Efficacy (lm/W):	113
Control:	On/off, Mains Dim, 0/1-10V, Dali, Zigbee, Casambi
Binning	2 Step MacAdams
Input:	AC220-240V 50/60Hz
Output:	DC 3V 650mA 3W
Ambient temp:	-20 °C to 45 °C
Class:	II

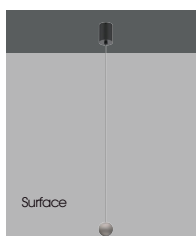
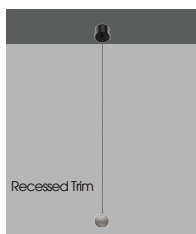

W system	lm system	optics	code
3W	148	15°	PVSR55003W-30N15-AG
3W	157	25°	PVSR55003W-30N25-AG
3W	179	30°	PVSR55003W-30N30-AG
3W	162	50°	PVSR55003W-30N50-AG
3W	159	60°	PVSR55003W-30N60-AG

W system	lm system	optics	code
3W	148	15°	PVSS55003W-30N15-AG
3W	157	25°	PVSS55003W-30N25-AG
3W	179	30°	PVSS55003W-30N30-AG
3W	162	50°	PVSS55003W-30N50-AG
3W	159	60°	PVSS55003W-30N60-AG

CONVEX

Φ70

Amber Pendant



Fixed Optic



Ceiling hook to move light point

-  White Painted
-  Black Painted
-  Satin Gold



view on website



cutout :58mm

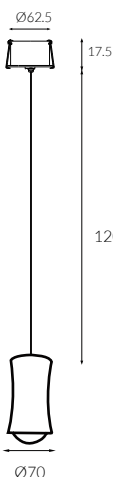

Recessed Trim

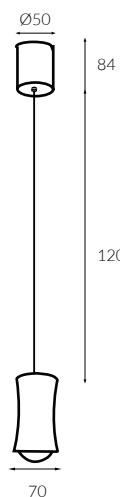

Surface

IP Rating:	IP20
Optics:	/
UGR:	<10
CRI:	/
Lifetime:	>50,000 hrs (L70 B10)
CCT:	Amber
Typical Source	
Efficacy (lm/W):	23
Control:	On/off, Mains Dim, 0/1-10V, Dali, Zigbee, Casambi
Binning	2 Step MacAdams
Input:	AC220-240V 50/60Hz
Output:	7W
Ambient temp:	-20 °C to 45 °C
Class:	II

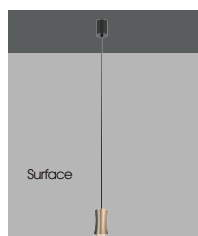

W system	lm system	optics	code
Amber			
7W	235	-	PSS7007W-ABN00-SG

W system	lm system	optics	code
Amber			
7W	235	-	PSR7007W-ABN00-SG

RING

Surface Circle Pendant



Fixed Optic

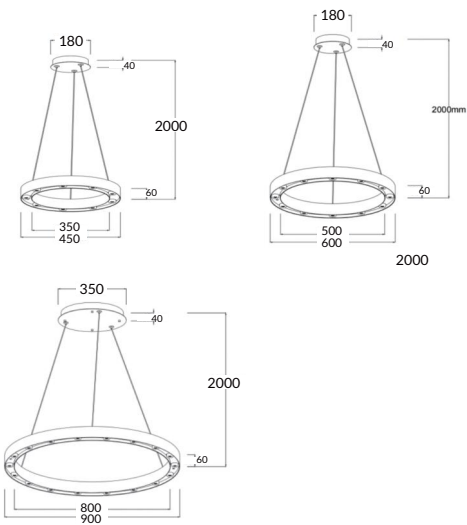

Black Painted

IP Rating:	IP20
Optics:	24°
UGR:	<10
CRI:	92Ra
Lifetime:	>50,000 hrs (L70 B10)
CCT:	3000K
Typical Source	
Efficacy (lm/W):	103
Control:	On/off, Mains Dim, 0/1-10V, Dali, Zigbee, Casambi
Binning	2 Step MacAdams
Input:	AC220-240V 50/60Hz
Output:	DC9-20V 600mA x 2 18W DC9-20V 600mA x 3 24W DC9-20V 600mA x 3 42W
Ambient temp:	-20 °C to 45 °C
Class:	II



W system	lm system	optics	size	code
18W	900	24°	450mm	LCP45018W



W system	lm system	optics	size	code
24W	1200	24°	600mm	LCP60024W



W system	lm system	optics	size	code
42W	2100	24°	900mm	LCP90042W

WALL, FLOOR& PORTABLE

ACME MINI STEP / SPARKLE STEP / RIFT STEP / ACME WALL /

GLOWALL / RADIANCE / AEGEAN / BELLA

ACME MINI STEP



view on website

Φ36 Engine Wall /Path Light



cutout:36mm



Wall Wash Optic

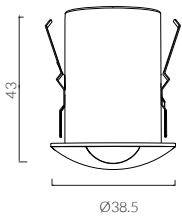

bezel



Black Painted



Accessories not included

Concrete recessing kit

IP Rating:	IP20
Optics:	Asymmetrical Wallwash
UGR:	<10
CRI:	92Ra
Lifetime:	>50,000 hrs (L70 B10)
CCT:	3000K/3500K
Typical Source	
Efficacy (lm/W):	103
Control:	On/off, Mains Dim, 0/1-10V, Dali, Zigbee, Casambi
Binning	2 Step MacAdams
Input:	AC220-240V 50/60Hz
Output:	DC 3V 300mA 1.3W DC 3V 650mA 3W
Ambient temp:	-20 °C to 45 °C
Class:	II
Ceiling Thickness:	5mm-28mm
Material:	Fine aluminium 6063A

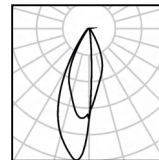

3W Ra92 3000K
Asymmetrical

h(m)	E(lx)	D(m)
0.5	130	0.47
1.0	33	0.94
1.5	14	1.41
2.0	8	1.88
2.5	5	2.35
3.0	4	2.82

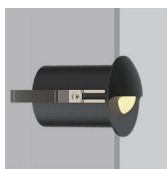

W system	lm system	optics	code
1.3W	31	Asymmetrical Wallwash	MFL361.3W-30NWS-B
3W	52	Asymmetrical Wallwash	MFL3603W-30NWS-B





DuraGreen project:
London Home

SPARKLE STEP

Φ35 Step Lights



Compact yet mighty recessed wall fixture, ideal for creating enchanting mood light along staircases, pathways, and other darker areas in your home.



view on website



- IP Rating:** IP20
- Optics:** /
- UGR:** <17
- CRI:** 92Ra
- Lifetime:** >50,000 hrs (L70 B10)
- CCT:** 3000K
- Typical Source Efficacy (lm/W):** 103
- Control:** On/off, Mains Dim, 0/1-10V, Dali, Zigbee, Casambi
- Binning:** 2 Step MacAdams
- Input:** AC220-240V 50/60Hz
- Output:** DC 3V 300mA 1.3W
DC 3V 650mA 3W
- Ambient temp:** -20 C to 45 C
- Class :** II

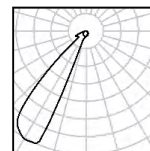

-5 3W Ra92 3000K
Asymmetrical

h(m)	E lx	D(m)
0.5	1	1.46
1.0	0	2.91
1.5	0	4.37
2.0	0	5.82
2.5	0	7.28
3.0	0	8.73

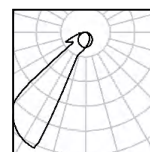

-6 3W Ra92 3000K
Asymmetrical

h(m)	E lx	D(m)
0.5	2	1.55
1.0	0	3.09
1.5	0	4.64
2.0	0	6.18
2.5	0	7.73
3.0	0	9.27



DuraGreen project:
Yacht Hotel by DC



W system	lm system	code
1.3W	17	WFL351.3W-1
3W	29	WFL3503W-1



W system	lm system	code
1.3W	17	WFL351.3W-2
3W	29	WFL3503W-2



W system	lm system	code
1.3W	8	WFL351.3W-5
3W	12	WFL3503W-5



W system	lm system	code
1.3W	19	WFL351.3W-6
3W	30	WFL3503W-6



W system	lm system	code
1.3W	17	WFL351.3W-8
3W	29	WFL3503W-8





DuraGreen Project : GZ Design Studio

RIFT STEP



view on website

80*40 Step Lights Vertical



Fixed Optic



White Painted

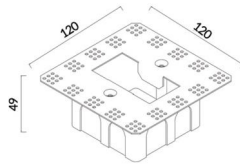

cutout :86*86mm

trimless installation in 86*86 wall box

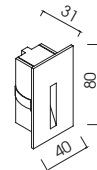

cutout :70*35mm

installation in hollow walls

IP Rating:	IP20
Optics:	/
UGR:	<17
CRI:	92Ra
Lifetime:	>50,000 hrs (L70 B10)
CCT:	3000K
Typical Source	
Efficacy (lm/W):	103
Control:	On/off, Mains Dim, 0/1-10V, Dali, Zigbee, Casambi
Binning:	2 Step MacAdams
Input:	AC220-240V 50/60Hz
Output:	DC 3V 300mA 1.3W DC 3V 650mA 3W
Ambient temp:	-20 °C to 45 °C
Class :	II

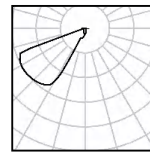

3W Ra92 3000K
Asymmetrical

h(m)	E lx	D(m)
0.5	5	0.51
1.0	1	1.01
1.5	1	1.52
2.0	0	2.03
2.5	0	2.54
3.0	0	3.04



DuraGreen project:
London Home



W system	lm system	code
1.3W	18	WFL70351.3W

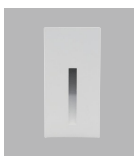

W system	lm system	code
3W	31	WFL703503W

Φ57 Engine Wall Light



view on website



Fixed Optic

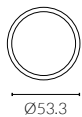
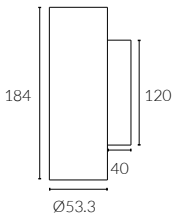

-C
optional curve baffle

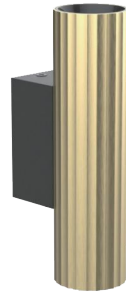

bespoke
Faceted Brass



White Painted



Black Painted



Brushed Grey



Antique Bronze



Solid Brass



Faceted Brass

IP Rating:	IP20 and IP44 options
Optics:	15°/24°/36°
UGR:	< 10
CRI:	98Ra
Lifetime:	>50,000 hrs (L70 B10)
CCT:	2700K/3000K/3500K/4000K/5000K/ 2000K-3000K/1800K-4000K/2700K-6000K

Typical Source	
Efficacy (lm/W):	110
Control:	On/off, Mains Dim, 0/1-10V, Dali, Zigbee, Casambi
Binning	2 Step MacAdams
Input:	AC220-240V 50/60Hz
Output:	DC 36V 250mA 10Wx2
Ambient temp:	-20 °C to 45 °C
Class:	II
Optional accessories:	Honeycomb louvre, Solite Lense, Spread Lense, Colour Filter
Material:	Fine aluminium 6063A

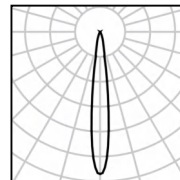

10W Ra98 3000K 15°

h(m)	E(lx)	D(m)
0.5	10728	0.15
1.0	2682	0.31
1.5	1192	0.46
2.0	671	0.61
2.5	429	0.77
3.0	298	0.92

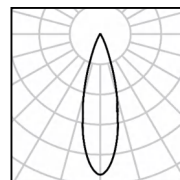

10W Ra98 3000K 24°

h(m)	E(lx)	D(m)
0.5	7580	0.21
1.0	1895	0.42
1.5	842	0.63
2.0	474	0.84
2.5	303	1.04
3.0	211	1.25

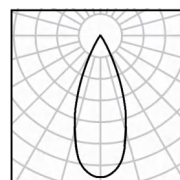

10W Ra98 3000K 36°

h(m)	E(lx)	D(m)
0.5	4206	0.28
1.0	1051	0.57
1.5	467	0.85
2.0	263	1.14
2.5	168	1.42
3.0	117	1.71



DuraGreen project:
DuraGreen Lighting Showroom

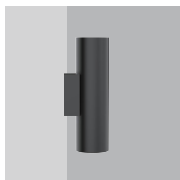

W system	lm system	optics	code
10Wx 2	462x 2	15°	WE5710WX2-30N15-B
10Wx 2	628x 2	24°	WE5710WX2-30N24-B
10Wx 2	616x 2	36°	WE5710WX2-30N36-B

Φ68 Engine Wall Light







view on website



Fixed Optic



-  White Painted
-  Black Painted
-  Antique Bronze
-  Brushed Grey

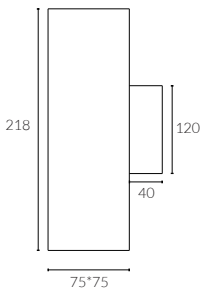

- IP Rating:** IP20 and IP44 options
- Optics:** 15°/24°/36°/50°
- UGR:** <10
- CRI:** 98Ra
- Lifetime:** >50,000 hrs (L70 B10)
- CCT:** 2700K/3000K/3500K/4000K/5000K/
2000K-3000K/1800K-4000K/2700K-6000K

- Typical Source Efficacy (lm/W):** 110
- Control:** On/off, Mains Dim, 0/1-10V, Dali, Zigbee, Casambi
- Binning:** 2 Step MacAdams
- Input:** AC220-240V 50/60Hz
- Output:** DC 36V 200mA 8Wx2
DC 36V 250mA 10Wx2
DC 36V 300mA 12Wx2
- Ambient temp:** -20 °C to 45 °C
- Class:** II
- Optional accessories:** Honeycomb louvre, Solite Lense, Spread Lense, Colour Filter
- Material:** Fine aluminium 6063A

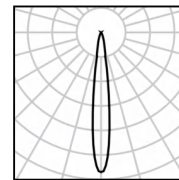

12W Ra98 3000K 15°

h(m)	E(lx)	D(m)
0.5	10897	0.17
1.0	2724	0.33
1.5	1211	0.50
2.0	681	0.66
2.5	436	0.83
3.0	303	0.99

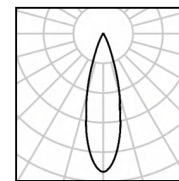

12W Ra98 3000K 24°

h(m)	E(lx)	D(m)
0.5	8621	0.20
1.0	2155	0.41
1.5	958	0.61
2.0	539	0.81
2.5	345	1.02
3.0	239	1.22

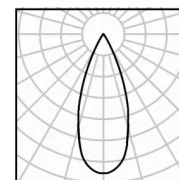

12W Ra98 3000K 36°

h(m)	E(lx)	D(m)
0.5	4792	0.28
1.0	1198	0.55
1.5	532	0.83
2.0	300	1.10
2.5	192	1.38
3.0	133	1.65

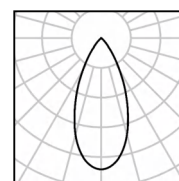

12W Ra98 3000K 50°

h(m)	E(lx)	D(m)
0.5	1608	0.47
1.0	402	0.93
1.5	179	1.40
2.0	100	1.87
2.5	64	2.33
3.0	45	2.80



W system	Im system	optics	code
8Wx2	487x2	15°	WQE6808Wx2-30N15-B
8Wx2	503x2	24°	WQE6808Wx2-30N24-B
8Wx2	492x2	36°	WQE6808Wx2-30N36-B
8Wx2	427x2	50°	WQE6808Wx2-30N50-B



W system	Im system	optics	code
10Wx2	553x2	15°	WQE6810Wx2-30N15-B
10Wx2	575x2	24°	WQE6810Wx2-30N24-B
10Wx2	565x2	36°	WQE6810Wx2-30N36-B
10Wx2	485x2	50°	WQE6810Wx2-30N50-B



W system	Im system	optics	code
12Wx2	717x2	15°	WQE6812Wx2-30N15-B
12Wx2	760x2	24°	WQE6812Wx2-30N24-B
12Wx2	750x2	36°	WQE6812Wx2-30N36-B
12Wx2	640x2	50°	WQE6812Wx2-30N50-B

GLOWALL

Reading Light WBBC150



view on website

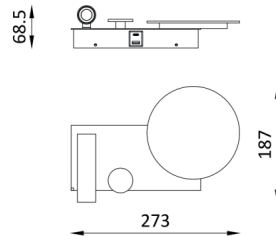

White Painted

IP Rating:	IP20
Optics:	90°+15°
UGR:	<17
CRI:	92Ra
Lifetime:	>50,000 hrs (L70 B10)
CCT:	3000K
Typical Source	
Efficacy (lm/W):	103
Control:	On/off, Mains Dim, 0/1-10V, Dali, Zigbee, Casambi
Binning	2 Step MacAdams
Input:	AC220-240V 50/60Hz
Output:	DC 36V 300mA 12W+DC 3V 650mA 3W
Ambient temp:	-20 °C to 45 °C
Class:	II



W system	lm system	optics	code
12W+3W	828+244	90° + 15°	WBBC150-L-30N9015-W



W system	lm system	optics	code
12W+3W	828+244	90° + 15°	WBBC150-R-30N9015-W

RADIANCE

200X200 Wall Sconce



Asymmetric wall-washing



view on website

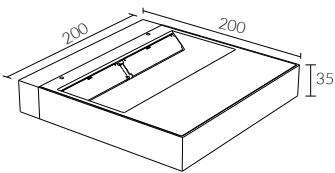

IP Rating:	IP20
Optics:	Asymmetric wall-washing
UGR:	< 10
CRI:	92Ra
Lifetime:	>50,000 hrs (L70 B10)
CCT:	3000K
Typical Source Efficacy (lm/W):	110
Control:	On/off, Mains Dim, 0/1-10V, Dali, Zigbee, Casambi
Binning	2 Step MacAdams
Input:	AC220-240V 50/60Hz
Output:	DC 36V 750mA 30W
Ambient temp:	-20 °C to 45 °C
Class:	II

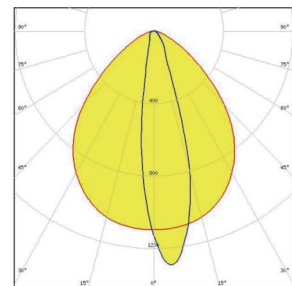



W system	lm system	optics	code
30W	2715	Asymmetric	W20030W-30NW-W

ULTRAFIN



This range of light fittings is extremely small yet powerful, designed for use in showcases. It represents the pinnacle of LED technology and component miniaturization.



ULTRAFIN

Φ12.4 Showcase



view on website

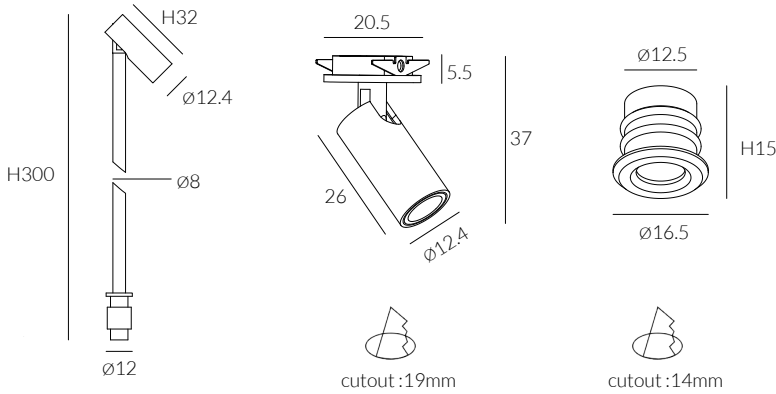

IP Rating:	IP20 and IP44 options
Optics:	15°/25°
UGR:	<10
CRI:	92Ra
Lifetime:	>50,000 hrs (L70 B10)
CCT:	2700K/3000K/3500K
Typical Source	
Efficacy (lm/W):	113
Control:	On/off, Mains Dim, 0/1-10V, Dali, Zigbee, Casambi
Binning	2 Step MacAdams
Input:	AC220-240V 50/60Hz
Output:	DC 3V 300mA 1.3W
Ambient temp:	-20 °C to 45 °C
Class:	II
Material:	Fine aluminium 6063A

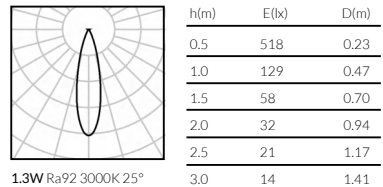
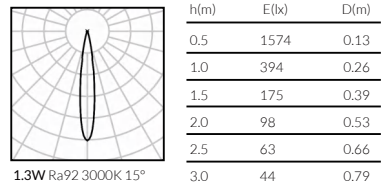

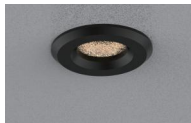

W system	lm system	optics	code
1.3W	79	15°	MFL141.3W-30N15
1.3W	71	25°	MFL141.3W-30N25

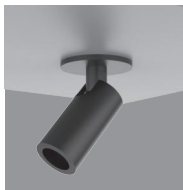

W system	lm system	optics	code
1.3W	79	15°	MAR121.3W-30N15
1.3W	71	25°	MAR121.3W-30N25



W system	lm system	optics	code
1.3W	79	15°	F121.3W-30N15
1.3W	71	25°	F121.3W-30N25

BELLA

Φ41

Zoomable 20°-50° Table Light



view on website

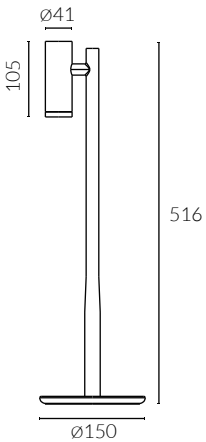

Antique Bronze

IP Rating:	IP20
Optics:	Zoomable 20°-50°
UGR:	<17
CRI:	92Ra
Lifetime:	>50,000 hrs (L70 B10)
CCT:	3000K/3500K
Typical Source	
Efficacy (lm/W):	96
Control:	On/off
Binning	2 Step MacAdams
Input:	48VDC
Output:	12V 400mA 6W
Ambient temp:	-20 °C to 45 °C
Class:	II
Material:	Fine aluminium 6063A

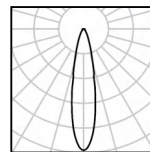

8W Ra92 3000K 20°

h(m)	E(lx)	D(m)
0.5	2978	0.21
1.0	745	0.42
1.5	331	0.63
2.0	186	0.84
2.5	119	1.04
3.0	83	1.25

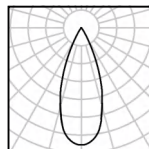

8W Ra92 3000K 30°

h(m)	E(lx)	D(m)
0.5	1805	0.30
1.0	451	0.59
1.5	201	0.89
2.0	113	1.18
2.5	72	1.48
3.0	50	1.78

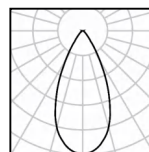

8W Ra92 3000K 50°

h(m)	E(lx)	D(m)
0.5	795	0.49
1.0	199	0.97
1.5	88	1.46
2.0	50	1.94
2.5	32	2.43
3.0	22	2.91



DuraGreen project:
Rimadesio Showroom



W system	Spots	lm system	optics	code
6W	1 Spot	296	20°- 50°	T14106W-30N2050-AB

BELLA

Φ41

Zoomable 20°-50° Floor Light



view on website

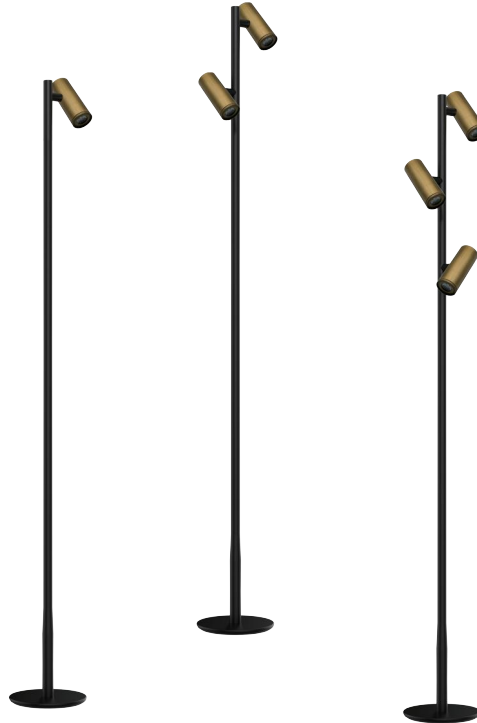
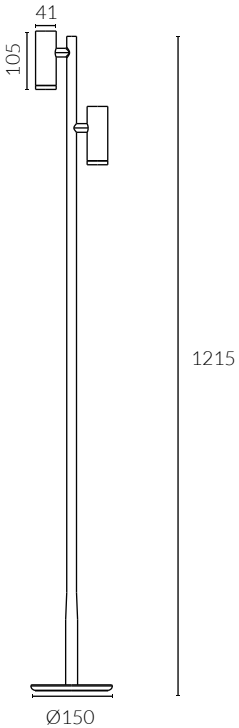

 Antique Bronze

- IP Rating:** IP20
- Optics:** Zoomable 20°-50°
- UGR:** <17
- CRI:** 92Ra
- Lifetime:** >50,000 hrs (L70 B10)
- CCT:** 3000K/3500K
- Typical Source**
- Efficacy (lm/W):** 96
- Control:** On/off
- Binning** 2 Step MacAdams
- Input:** 48VDC
- Output:** 12V 400mA 6W
- Ambient temp:** -20 °C to 45 °C
- Class:** II
- Material:** Fine aluminium 6063A

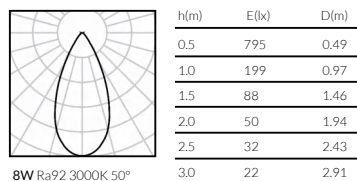
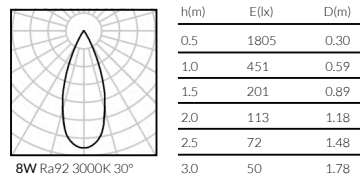
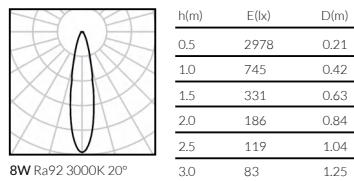



DuraGreen project:
Rimadesio Showroom

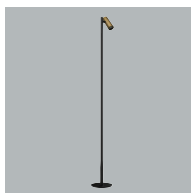

W system	Spots	lm system	optics	code
6W	1 Spot	292- 296	20°- 50°	F14106WX1-30N2050-AB

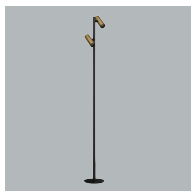

W system	Spots	lm system	optics	code
6W*2	2 Spot	296*2-296*2	20°- 50°	F24106WX2-30N2050-AB

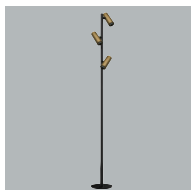

W system	Spots	lm system	optics	code
6W*3	3 Spot	296*3-296*3	20°- 50°	F34106WX3-30N2050-AB

TRACK 48V

Stucchi compatible track adaptors

DECO TRACK / MINI-LINE 22 / ARTFOCUS / ORBIT / DIVINO /

BELLA / GLAMO / EVOLINE / BOLUX / HALO / ACME / CAPRI

TRACK 48V



Deco Track offers a modular and decorative lighting solution that brings unlimited flexibility and impeccable design to any space. Ideal for premium residential or commercial interiors, such as open kitchens, dining rooms, and reception desks, this sleek track system effortlessly adds sophistication to your home.

Unleash your creative vision and experience the perfect fusion of functionality and style with Deco Track.



DECO TRACK 48V

Surface Round



view on website



 Black Painted

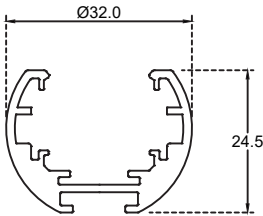

Accessories not included

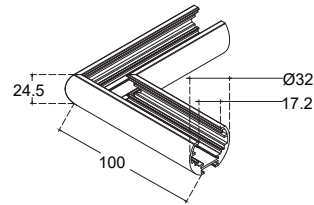

M22-LSS-C-1

Surface horizontal L connector

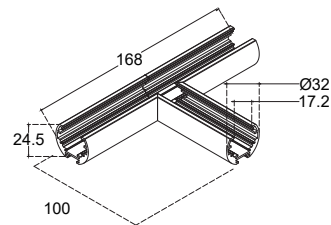

M22-LSS-C-3

Surface horizontal T connector

Code:	TC22ST-C
Type:	Low voltage track
Material:	Aluminum
Finishing:	Black
Mounting:	Pendant
IP rating:	IP20
Insulation:	class III
Control gear:	Remote power supply (not included)
Dimensions:	W:32mm H:24.5 L: 2000 mm
Voltage connection:	48 VDC
Circuits:	1x 15 A · 48 VDC
Note:	Pendant accessories included

DECO TRACK 48V

Surface Micro



view on website



matt black

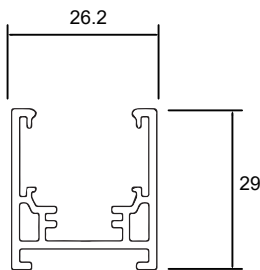

Accessories not included

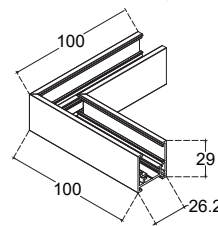

M22-LSS-S-1

Surface horizontal L connector

Code:	TC22ST-S
Type:	Low voltage track
Material:	Aluminum
Finishing:	Black
Mounting:	Surface/Pendant
IP rating:	IP20
Insulation:	class III
Control gear:	Remote power supply (not included)
Dimensions:	W:60mm H:24.6 L: 2000 mm
Cut out for plasterboard:	W:34mm * H:>25mm * L
Voltage connection:	48 VDC
Circuits:	1 x 15 A · 48 VDC
Note:	Pendant accessories included

MINI-LINE 22 48V

Surface



view on website



Black Painted

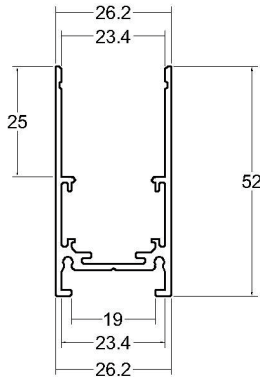

Accessories not included

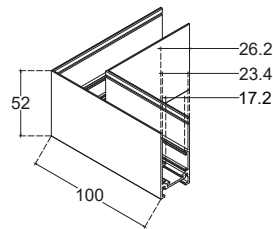

M22-LSS-1

Surface horizontal L connector

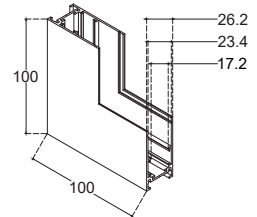

M22-LSS-2

Surface inner vertical L connector

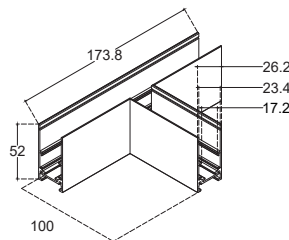

M22-LSS-3

Surface horizontal T connector

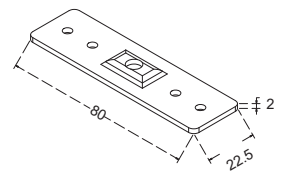

M22-LSS-8

Reinforcing plate
(For joining two straight pieces of track)

Code:	TC22ST
Type:	Low voltage track
Material:	Aluminum
Finishing:	Black
Mounting:	Surface
IP rating:	IP20
Insulation:	class III
Control gear:	Remote power supply (not included)
Dimensions:	W:26mm H:52 L: 1000 mm 2000 mm 3000 mm
Voltage connection:	48 VDC
Circuits:	1 x 15 A · 48 VDC
Note:	The supply connectors, plugs and further fixture accessories must be ordered separately.

MINI-LINE 22 48V

Trimless 12.8



view on website



Black Painted

Accessories not included

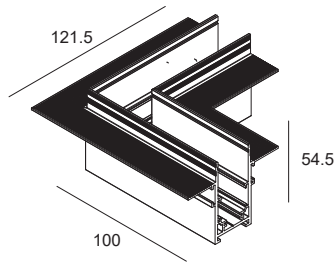

M22-LRS-1

Trimless horizontal L connector

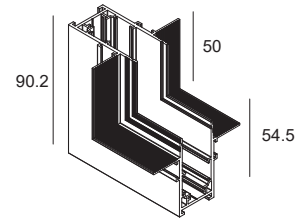

M22-LRS-2

Trimless inner vertical L connector

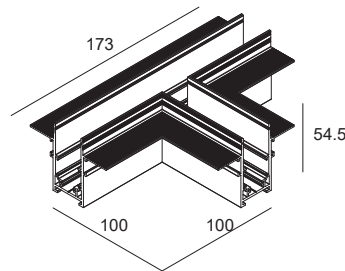
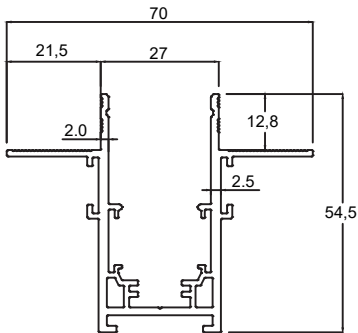

M22-LRS-3

Trimless horizontal T connector

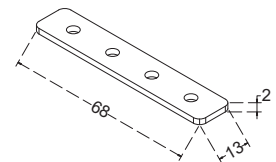

M22-LRS-8

Reinforcing plate
(For joining two straight pieces of track)

Code:	TC22RT
Type:	Low voltage track
Material:	Aluminum
Finishing:	Black
Mounting:	Trimless
IP rating:	IP20
Insulation:	class III
Control gear:	Remote power supply (not included)
Dimensions:	W:70mm H:54 L: 1000 mm 2000 mm 3000 mm
Cut out for plasterboard:	W:34mm * H:>43mm * L
Voltage connection:	48 VDC
Circuits:	1 x 15 A · 48 VDC
Note:	The supply connectors, plugs and further fixture accessories must be ordered separately.

Accessories

THROUGH JOINT



TECHNICAL FEATURES

Code	M22-LSS-4
Type	Through joint
Material	Polycarbonate
Finishing	Black
Fixing	Plug-in
Insulation class	III
Voltage	20 A max · 48 VDC

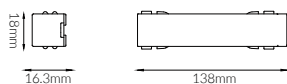

POWER HEAD

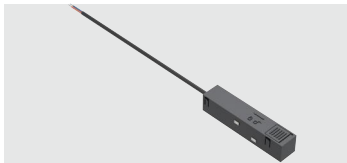

TECHNICAL FEATURES

Code	M22-LSS-5
Type	Non-polarised power head
Material	Polycarbonate
Finishing	Black
Fixing	Plug-in
Insulation class	III
Voltage	20 A max · 48 VDC

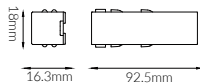

FLEXIBLE JOINT



TECHNICAL FEATURES

Code	M22-LSS-6
Type	Flexible joint
Material	Polycarbonate
Finishing	Black
Fixing	Plug-in
Insulation class	III
Voltage	20 A max · 48 VDC

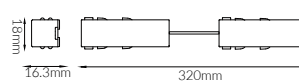

POWER SUPPLY



TECHNICAL FEATURES

Code	20D-48V100W 20D-48V150W
Type	Constant voltage driver
Fixing	Plug-in
Insulation class	-
Voltage	220V ~50/60Hz .48 VDC
Max wattage	100W max / 150W max
Dimension	298X27X22mm 350X27X22mm

POWER SUPPLY



TECHNICAL FEATURES

Code	LT-100-48 LT-150-48
Type	Constant voltage driver
Fixing	Plug-in
Insulation class	-
Voltage	220V ~50/60Hz .48 VDC
Max wattage	100W max / 150W max
Dimension	312x30x18.2mm 335x30x21.6mm

CLOSURE PLUG



TECHNICAL FEATURES

Code	M22-LSS-7
Type	Closure plug
Material	Polycarbonate
Finishing	Black RAL 9005
Fixing	By screws (included)

PENDANT ACCESSORIES



TECHNICAL FEATURES

Code	M22-LSS-S-W
Type	Suspension kit
Material	Steel

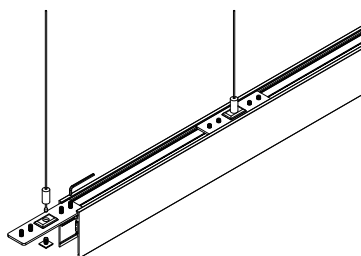





DuraGreen project:
Stellar Works Home

ARTFOCUS 48V

Φ36 Adjustable 48V Track Light



view on website



Adjustable Optic

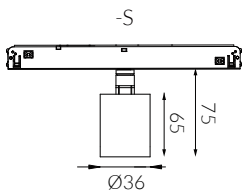

minimal track

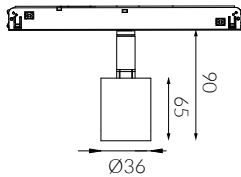

standard track



matt white painted



matt black painted

- IP Rating:** IP20 and IP44 options
- Optics:** 15°/28°/36°
- UGR:** <10
- CRI:** 98Ra
- Lifetime:** >50,000 hrs (L70 B10)
- CCT:** 2700K/3000K/3500K/4000K/5000K/
2000K-3000K/1800K-4000K/2700K-6000K
- Typical Source Efficacy (lm/W):** 110
- Control:** On/off, 0/1-10V, Dali, Zigbee, Casambi
- Binning** 2 Step MacAdams
- Input :** 48 VDC
- Output :** DC 36V 150mA 6W
- Ambient temp:** -20 °C to 45 °C
- Class:** III
- Material:** structure fine aluminum 6063A

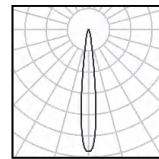

6W Ra98 3000K 15°

h(m)	E(lx)	D(m)
0.5	4937	0.14
1.0	1234	0.27
1.5	549	0.41
2.0	309	0.54
2.5	197	0.68
3.0	137	0.81

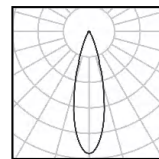

6W Ra98 3000K 28°

h(m)	E(lx)	D(m)
0.5	2848	0.25
1.0	712	0.49
1.5	316	0.74
2.0	178	0.98
2.5	114	1.23
3.0	79	1.47

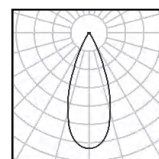

6W Ra98 3000K 36°

h(m)	E(lx)	D(m)
0.5	1706	0.31
1.0	426	0.62
1.5	190	0.93
2.0	107	1.25
2.5	68	1.56
3.0	47	1.87



DuraGreen project:
Steve O Art



W system	lm system	optics	code
6W	373	15°	TK3606W-30N15-B
6W	445	28°	TK3606W-30N28-B
6W	446	36°	TK3606W-30N36-B

ORBIT 48V

Φ35 Adjustable 48V Track Light



view on website

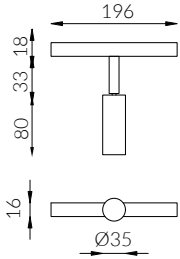

IP Rating:	IP20
Optics:	15°/30°/40°/55°
UGR:	<10
CRI:	98Ra
Lifetime:	>50,000 hrs (L70 B10)
CCT:	2700K/3000K/3500K/4000K/5000K/ 2000K-3000K/1800K-4000K/2700K-6000K
Typical Source	
Efficacy (lm/W):	110
Control:	On/off, 0/1-10V, Dali, Zigbee, Casambi
Binning	2 Step MacAdams
Input:	48 VDC
Output:	DC 36V 150mA 6W
Ambient temp:	-20 C to 45 C
Class:	III
Optional accessories:	Honeycomb louvre, Solite Lense, Spread Lense, Colour Filter

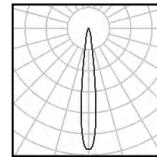

6W Ra98 3000K 15°

h(m)	E(lx)	D(m)
0.5	4391	0.14
1.0	1098	0.27
1.5	488	0.41
2.0	274	0.55
2.5	176	0.68
3.0	122	0.82

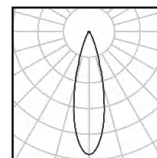

6W Ra98 3000K 30°

h(m)	E(lx)	D(m)
0.5	2085	0.28
1.0	521	0.55
1.5	232	0.83
2.0	130	1.10
2.5	83	1.38
3.0	58	1.65

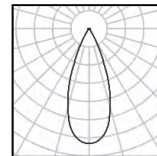

6W Ra98 3000K 40°

h(m)	E(lx)	D(m)
0.5	1572	0.38
1.0	393	0.76
1.5	175	1.15
2.0	98	1.53
2.5	63	1.91
3.0	44	2.29

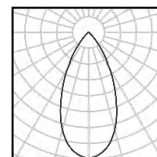

6W Ra98 3000K 55°

h(m)	E(lx)	D(m)
0.5	707	0.53
1.0	177	1.07
1.5	79	1.60
2.0	44	2.14
2.5	28	2.67
3.0	20	3.20



DuraGreen project:
Schüller Showroom



W system	lm system	optics	code
6W	267	15°	M223506W-30N15-B
6W	353	30°	M223506W-30N30-B
6W	430	40°	M223506W-30N40-B
6W	415	55°	M223506W-30N55-B

ORBIT 48V

Φ45 Adjustable 48V Track Light



view on website

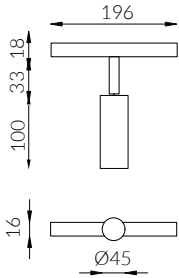

IP Rating: IP20
Optics: 15°/24°/36°/50°
UGR: <10
CRI: 98Ra
Lifetime: >50,000 hrs (L70 B10)
CCT: 2700K/3000K/3500K/4000K/5000K/
 2000K-3000K/1800K-4000K/2700K-6000K

Typical Source
Efficacy (lm/W): 110
Control: On/off, 0/1-10V, Dali, Zigbee, Casambi
Binning 2 Step MacAdams
Input: 48 VDC
Output: DC 36V 250mA 10W
Ambient temp: -20 °C to 45 °C
Class: III
Optional accessories: Honeycomb louvre, Solite Lense, Spread Lense,
 Colour Filter

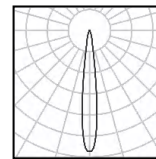

10W Ra98 3000K 15°

h(m)	E(lx)	D(m)
0.5	8822	0.15
1.0	2206	0.30
1.5	980	0.45
2.0	551	0.60
2.5	353	0.76
3.0	245	0.91

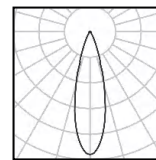

10W Ra98 3000K 24°

h(m)	E(lx)	D(m)
0.5	6615	0.23
1.0	1654	0.46
1.5	735	0.69
2.0	413	0.92
2.5	265	1.15
3.0	184	1.37

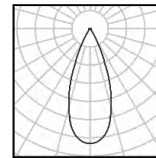

10W Ra98 3000K 36°

h(m)	E(lx)	D(m)
0.5	3458	0.32
1.0	864	0.65
1.5	384	0.97
2.0	216	1.29
2.5	138	1.61
3.0	96	1.94

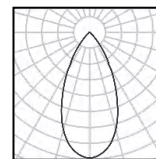

10W Ra98 3000K 50°

h(m)	E(lx)	D(m)
0.5	2048	0.45
1.0	512	0.89
1.5	228	1.34
2.0	128	1.79
2.5	82	2.24
3.0	57	2.68



DuraGreen project:
Stellar Works Home



W system	lm system	optics	code
10W	501	15°	M224510W-30N15-B
10W	653	24°	M224510W-30N24-B
10W	692	36°	M224510W-30N36-B
10W	676	50°	M224510W-30N50-B

ORBIT 48V

Φ55 Adjustable 48V Track Light



view on website

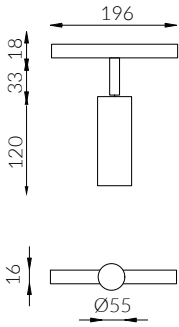

-  White Painted
-  Black Painted

- IP Rating:** IP20
- Optics:** 12°/20°/30°/40°
- UGR:** <10
- CRI:** 98Ra
- Lifetime:** >50,000 hrs (L70 B10)
- CCT:** 2700K/3000K/3500K/4000K/5000K/
2000K-3000K/1800K-4000K/2700K-6000K
- Typical Source**
- Efficacy (lm/W):** 110
- Control:** On/off, 0/1-10V, Dali, Zigbee, Casambi
- Binning** 2 Step MacAdams
- Input:** 48VDC
- Output:** DC 36V 350mA 15W
- Ambient temp:** -20 °C to 45 °C
- Class:** III
- Optional accessories:** Honeycomb louvre, Solite Lense, Spread Lense,
Colour Filter

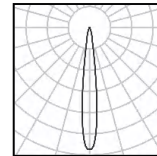

15W Ra98 3000K 12°

h(m)	E lx	D(m)
0.5	19862	0.11
1.0	4965	0.22
1.5	2207	0.33
2.0	1241	0.43
2.5	794	0.54
3.0	552	0.65

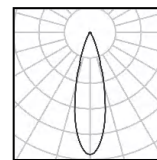

15W Ra98 3000K 20°

h(m)	E lx	D(m)
0.5	11574	0.18
1.0	2894	0.36
1.5	1286	0.54
2.0	723	0.72
2.5	463	0.90
3.0	322	1.08

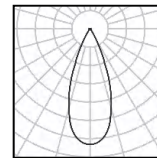

15W Ra98 3000K 30°

h(m)	E lx	D(m)
0.5	6165	0.27
1.0	1541	0.54
1.5	685	0.80
2.0	385	1.07
2.5	247	1.34
3.0	171	1.61

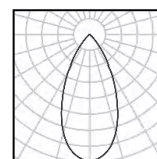

15W Ra98 3000K 40°

h(m)	E lx	D(m)
0.5	2648	0.38
1.0	662	0.76
1.5	294	1.15
2.0	166	1.53
2.5	106	1.91
3.0	74	2.29



DuraGreen project:
DRAENER Showroom



W system	lm system	optics	code
15W	808	12°	M225515W-30N12-B
15W	896	20°	M225515W-30N20-B
15W	956	30°	M225515W-30N30-B
15W	906	40°	M225515W-30N40-B

ORBIT 48V

Φ65 Adjustable 48V Track Light



view on website

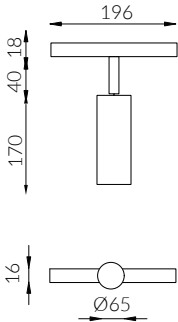

-  White Painted
-  Black Painted

- IP Rating:** IP20
- Optics:** 15°/24°/36°/50°
- UGR:** < 10
- CRI:** 98Ra
- Lifetime:** > 50,000 hrs (L70 B10)
- CCT:** 2700K/3000K/3500K/4000K/5000K/
2000K-3000K/1800K-4000K/2700K-6000K
- Typical Source**
- Efficacy (lm/W):** 110
- Control:** On/off, 0/1-10V, Dali, Zigbee, Casambi
- Binning** 2 Step MacAdams
- Input:** 48 VDC
- Output:** DC 36V 700mA 30W
- Ambient temp:** -20 C to 45 C
- Class:** III
- Optional accessories:** Honeycomb louvre, Solite Lense, Spread Lense, Colour Filter

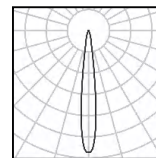

30W Ra98 3000K 15°

h(m)	E(lx)	D(m)
0.5	36897	0.12
1.0	9224	0.25
1.5	4100	0.37
2.0	2306	0.50
2.5	1476	0.62
3.0	1025	0.75

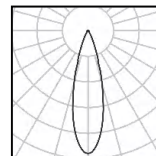

30W Ra98 3000K 24°

h(m)	E(lx)	D(m)
1.0	29283	0.18
2.0	7321	0.36
3.0	3254	0.53
4.0	1830	0.71
5.0	1171	0.89
6.0	813	1.07

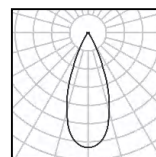

30W Ra98 3000K 36°

h(m)	E(lx)	D(m)
1.0	11973	0.32
2.0	2993	0.63
3.0	1330	0.95
4.0	748	1.26
5.0	479	1.58
6.0	333	1.89



DuraGreen project:
Poltrona Frau Flagship Store



W system	lm system	optics	code
30W	1706	15°	M226530W-30N15-B
30W	2219	24°	M226530W-30N24-B
30W	2184	36°	M226530W-30N36-B
30W	1965	50°	M226530W-30N50-B

ORBIT 48V

Φ45 Adjustable 48V Contour Spotlight



view on website

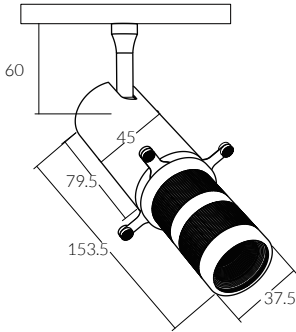

Black Painted



- IP Rating:** IP20
- Optics:** Framing
- UGR:** <10
- CRI:** 98Ra
- Lifetime:** >50,000 hrs (L70 B10)
- CCT:** 2700K/3000K/3500K/4000K/5000K/
2000K-3000K/1800K-4000K/2700K-6000K

Typical Source

- Efficacy (lm/W):** 110
- Control:** On/off, 0/1-10V, Dali, Zigbee, Casambi
- Binning:** 2 Step MacAdams
- Input:** 48 VDC
- Output:** DC 36V 250mA 10W
- Ambient temp:** -20 C to 45 C
- Class:** III

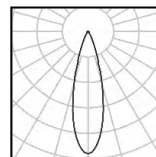

10W Ra98 3000K 24°

h(m)	E(lx)	D(m)
0.5	3216	0.21
1.0	804	0.42
1.5	357	0.63
2.0	201	0.84
2.5	129	1.04
3.0	89	1.25

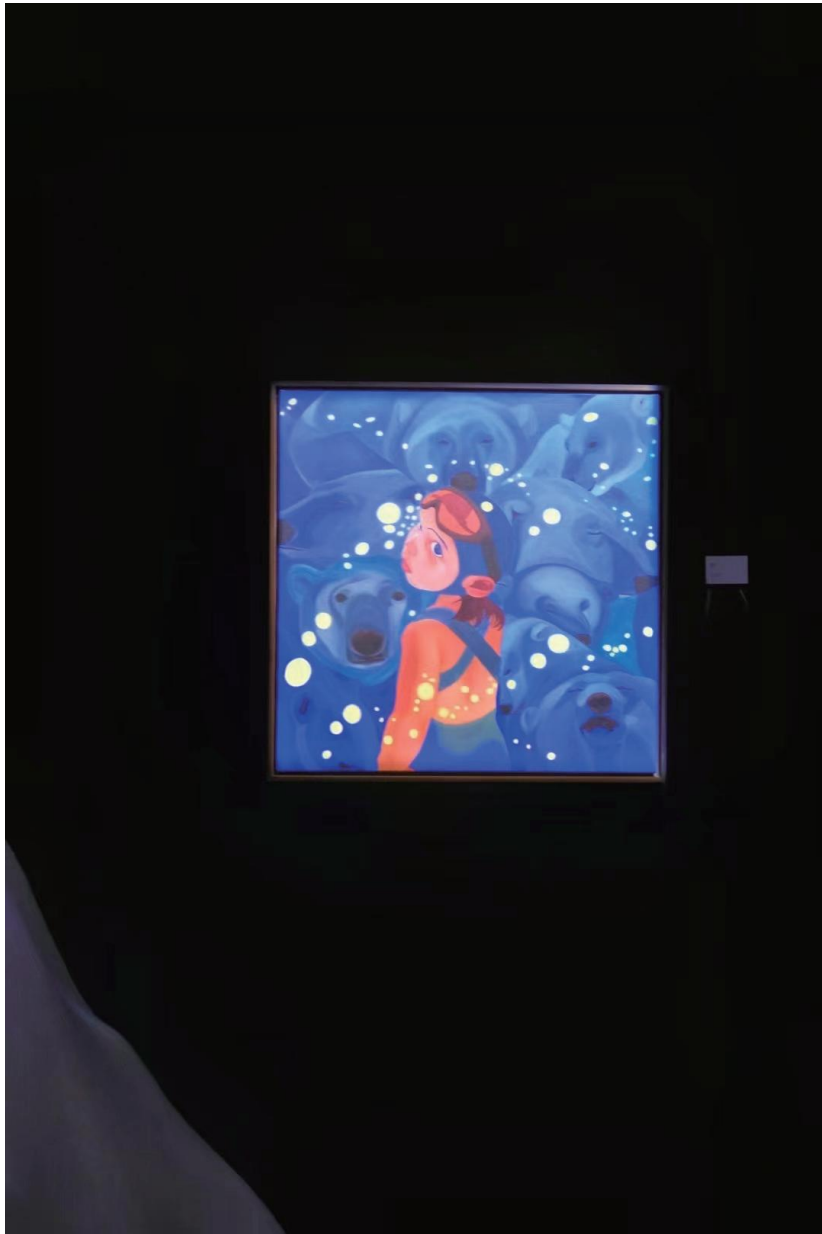

W system	lm system	code
10W	239	M22C4510W

DIVINO 48V

Φ35 Adjustable 48V Track Light



view on website

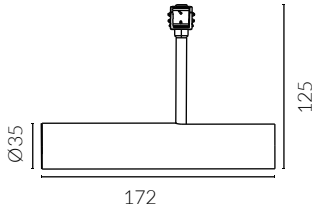

 Black Painted

IP Rating: IP20
Optics: 15°/30°/40°/55°
UGR: <10
CRI: 98Ra
Lifetime: >50,000 hrs (L70 B10)
CCT: 2700K/3000K/3500K/4000K/5000K/
 2000K-3000K/1800K-4000K/2700K-6000K

Typical Source
Efficacy (lm/W): 110
Control: On/off, 0/1-10V, Dali, Zigbee, Casambi
Binning 2 Step MacAdams
Input: 48 VDC
Output: DC 36V 300mA 12W
Ambient temp: -20 °C to 45 °C
Class: III
Optional accessories: Honeycomb louvre, Solite Lense, Spread Lense,
 Colour Filter

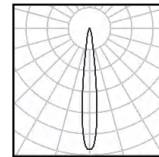

12W Ra98 3000K 15°

h(m)	E lx	D(m)
0.5	7106	0.14
1.0	1777	0.27
1.5	790	0.41
2.0	444	0.55
2.5	284	0.68
3.0	197	0.82

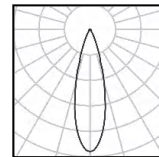

12W Ra98 3000K 30°

h(m)	E lx	D(m)
0.5	3379	0.28
1.0	845	0.56
1.5	375	0.84
2.0	211	1.12
2.5	135	1.40
3.0	94	1.68

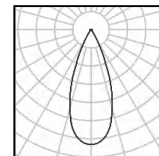

12W Ra98 3000K 40°

h(m)	E lx	D(m)
0.5	2710	0.38
1.0	678	0.75
1.5	301	1.13
2.0	169	1.50
2.5	108	1.88
3.0	75	2.26

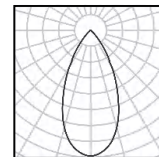

12W Ra98 3000K 55°

h(m)	E lx	D(m)
0.5	1235	0.51
1.0	309	1.01
1.5	137	1.52
2.0	77	2.03
2.5	49	2.54
3.0	34	3.04



W system	lm system	optics	code
12W	427	15°	M2235L12W-30N15-B
12W	582	30°	M2235L12W-30N30-B
12W	734	40°	M2235L12W-30N40-B
12W	703	55°	M2235L12W-30N55-B

BELLA 48V

Φ41 Zoomable 20°-50° 48V Track Light



view on website



Adjustable Optic

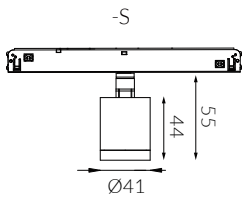

minimal track

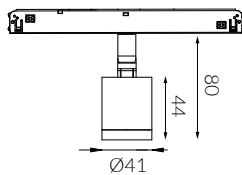

standard track

○ White Painted

● Black Painted

● Antique Bronze

● Brushed Grey

- IP Rating:** IP20
- Optics:** Zoomable 20°-50°
- UGR:** <17
- CRI:** 92Ra
- Lifetime:** >50,000 hrs (L70 B10)
- CCT:** 3000K/3500K/2700-6000K
- Typical Source**
- Efficacy (lm/W):** 96
- Control:** On/off, 0/1-10V, Dali, Zigbee, Casambi
- Binning:** 2 Step MacAdams
- Input:** 48 VDC
- Output:** DC 12V 350mA 6W
- Ambient temp:** -20 C to 45 C
- Class:** III
- Material:** structure fine aluminum 6063A

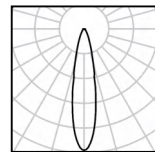

6W Ra92 3000K 20°

h(m)	E(lx)	D(m)
0.5	2355	0.20
1.0	589	0.40
1.5	262	0.59
2.0	147	0.79
2.5	94	0.99
3.0	65	1.19

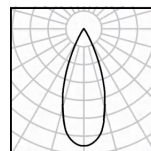

6W Ra92 3000K 30°

h(m)	E(lx)	D(m)
0.5	1378	0.29
1.0	344	0.58
1.5	153	0.88
2.0	86	1.17
2.5	55	1.46
3.0	38	1.75

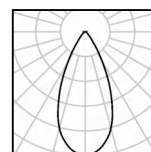

6W Ra92 3000K 50°

h(m)	E(lx)	D(m)
0.5	616	0.47
1.0	154	0.95
1.5	68	1.42
2.0	38	1.90
2.5	25	2.37
3.0	17	2.85



W system	lm system	optics	code
6W	292-296	20°- 50°	MT4106W-30N2050-B

GLAMO 48V

Φ68 Zoomable 15°-50° 48V Track Light



view on website



Adjustable Optic

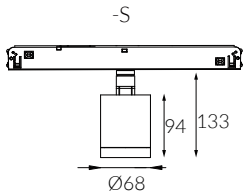

minimal track

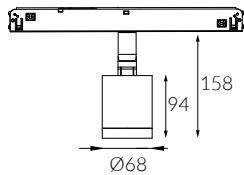

standard track



Black Painted

- IP Rating:** IP20
- Optics:** Zoomable 15°-50°
- UGR:** <17
- CRI:** 98Ra
- Lifetime:** >50,000 hrs (L70 B10)
- CCT:** 2700K/3000K/3500K/4000K/5000K/
2000K-3000K/1800K-4000K/2700K-6000K

Typical Source

- Efficacy (lm/W):** 113
- Control:** On/off, 0/1-10V, Dali, Zigbee, Casambi
- Binning:** 2 Step MacAdams
- Input:** 48 VDC
- Output:** DC 36V 150mA 6W
DC 36V 200mA 8W
DC 36V 250mA 10W
DC 36V 300mA 12W

- Ambient temp:** -20 C to 45 C
- Class:** III

Material: structure fine aluminum 6063A

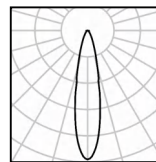

12W Ra98 3000K 15°

h(m)	E(lx)	D(m)
0.5	12099	0.14
1.0	3025	0.27
1.5	1344	0.41
2.0	756	0.54
2.5	484	0.68
3.0	336	0.81

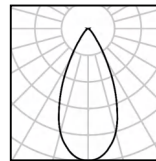

12W Ra98 3000K 40°

h(m)	E(lx)	D(m)
0.5	2174	0.38
1.0	544	0.76
1.5	242	1.14
2.0	136	1.52
2.5	87	1.90
3.0	60	2.28



DuraGreen project:
Valcucine Kitchen Flagship Store

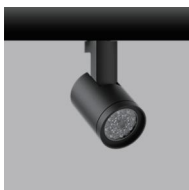

W system	lm system	optics	code
6W	437-433	15°- 50°	MT6806W-30N1550
8W	623-544	15°- 50°	MT6808W-30N1550
10W	585-589	15°- 50°	MT6810W-30N1550
12W	756-747	15°- 50°	MT6812W-30N1550

GLAMO 48V

Φ68 Adjustable 48V Contour Spotlight



view on website



Adjustable Optic



focus

zoom



Black Painted

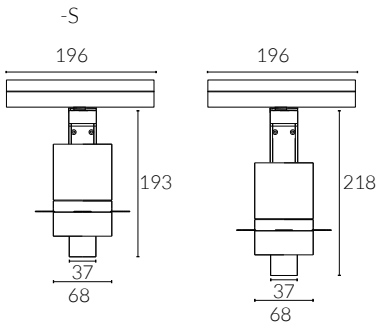

minimal track

standard track

IP Rating:	IP20
Optics:	Framing
UGR:	<10
CRI:	98Ra
Lifetime:	>50,000 hrs (L70 B10)
CCT:	2700K/3000K/3500K/4000K/5000K/2000K-3000K/1800K-4000K/2700K-6000K
Typical Source	
Efficacy (lm/W):	110
Control:	On/off, 0/1-10V, Dali, Zigbee, Casambi
Binning	2 Step MacAdams
Input:	48 VDC
Output:	DC 36V 250mA 10W
Ambient temp:	-20 °C to 45 °C
Class:	III
Material:	structure fine aluminum 6063A

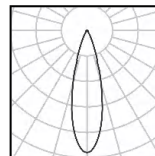

10W Ra98 3000K 24°

h(m)	E(lx)	D(m)
0.5	3216	0.21
1.0	804	0.42
1.5	357	0.63
2.0	201	0.84
2.5	129	1.04
3.0	89	1.25

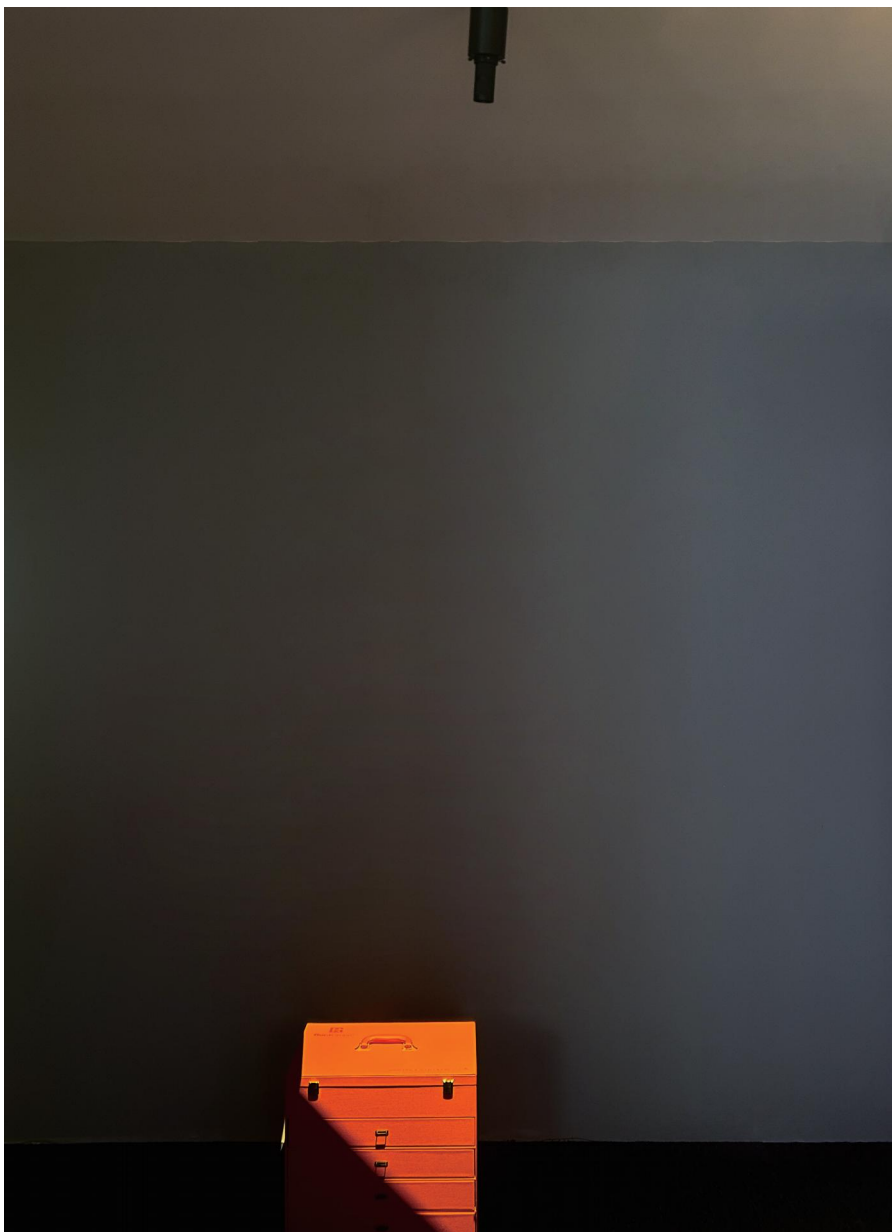

W system	lm system	code
10W	239	MC6810W

EVOLINE 48V

48V Dot Line Adjustable Version



view on website

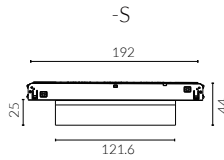

minimal track

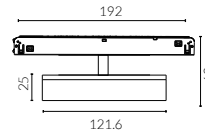

standard track

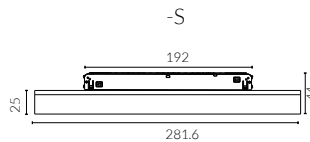

minimal track

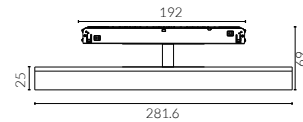

standard track



Black Painted

IP Rating: IP20
Optics: 36° / 65°
UGR: <17
CRI: 92Ra
Lifetime: >50,000 hrs (L70 B10)
CCT: 3000K/3500K/2700K-6000K

Typical Source

Efficacy (lm/W): 113
Control: On/off, 0/1-10V, Dali, Zigbee, Casambi
Binning 2 Step MacAdams
Input: 48 VDC
Output: DC 18V 350mA 8W
 DC 21V 450mA 12W

Ambient temp: -20 °C to 45 °C

Class: III

Material: structure fine aluminum 6063A

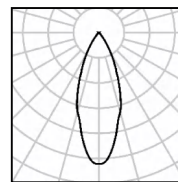

12W Ra92 3000K 36°

h(m)	E(lx)	D(m)
0.5	2278	0.34
1.0	569	0.68
1.5	253	1.00
2.0	142	1.40
2.5	91	1.70
3.0	63	2.10

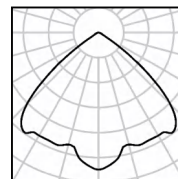

12W Ra92 3000K 65°

h(m)	E(lx)	D(m)
0.5	303	1.17
1.0	76	2.35
1.5	34	3.52
2.0	19	4.70
2.5	12	5.87
3.0	8	7.05



W system	lm system	optics	code
8W	428	36°	MLA0608W-30N36-B
8W	450	65°	MLA0608W-30N65-B



W system	lm system	optics	code
12W	642	36°	MLA1412W-30N36-B
12W	675	65°	MLA1412W-30N65-B

EVOLINE 48V

48V Dot Line Fixed Version



view on website

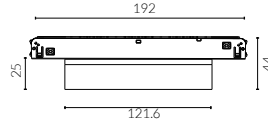

Black Painted

IP Rating:	IP20
Optics:	36° / 65°
UGR:	<17
CRI:	92Ra
Lifetime:	>50,000 hrs (L70 B10)
CCT:	3000K/3500K/2700K-6000K
Typical Source	
Efficacy (lm/W):	113
Control:	On/off, 0/1-10V, Dali, Zigbee, Casambi
Binning	2 Step MacAdams
Input:	48 VDC
Output:	DC 18V 350mA 8W DC 21V 450mA 12W
Ambient temp:	-20 °C to 45 °C
Class:	III
Material:	structure fine aluminum 6063A

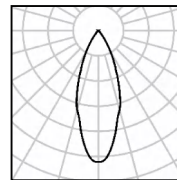

12W Ra92 3000K 36°

h(m)	E(lx)	D(m)
0.5	2278	0.34
1.0	569	0.68
1.5	253	1.00
2.0	142	1.40
2.5	91	1.70
3.0	63	2.10

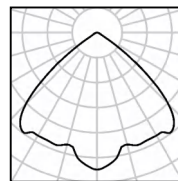

12W Ra92 3000K 65°

h(m)	E(lx)	D(m)
0.5	303	1.17
1.0	76	2.35
1.5	34	3.52
2.0	19	4.70
2.5	12	5.87
3.0	8	7.05

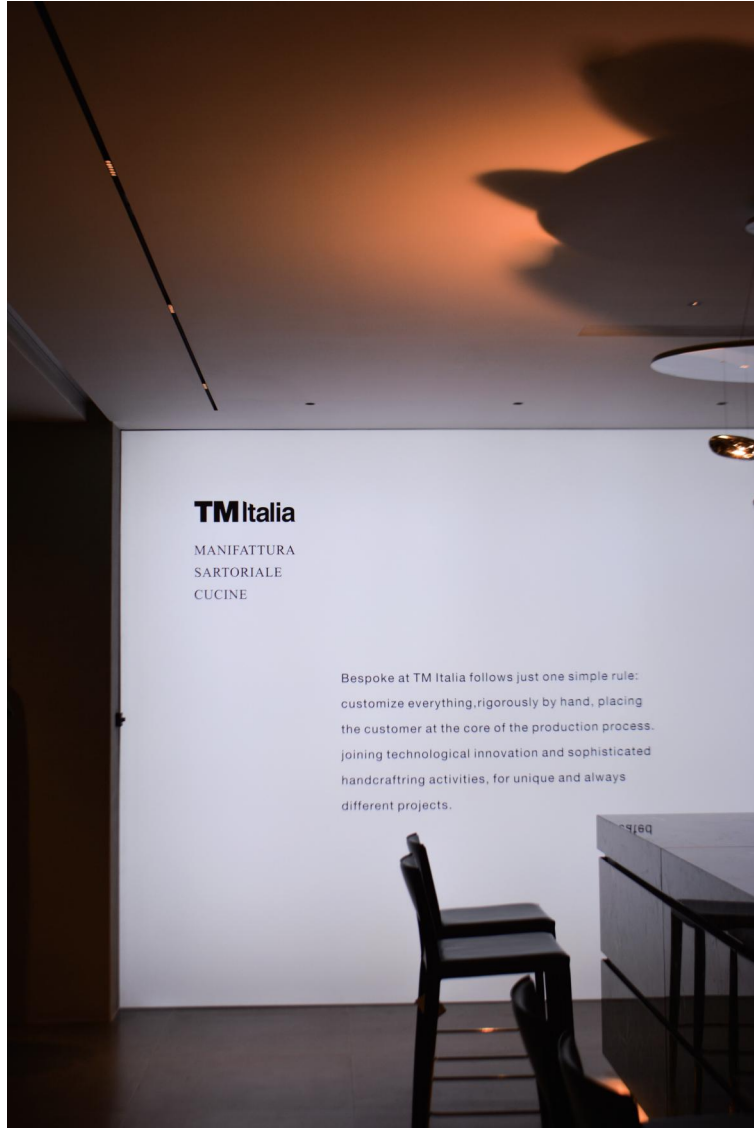

DuraGreen project:
Versace Showroom

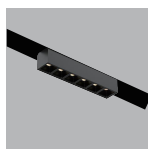

W system	lm system	optics	code
8W	428	36°	MLF0608W-30N36-B
8W	450	65°	MLF0608W-30N65-B



W system	lm system	optics	code
12W	642	36°	MLF1412W-30N36-B
12W	675	65°	MLF1412W-30N65-B

EVOLINE 48V

48V Dot Line Fixed Version



view on website

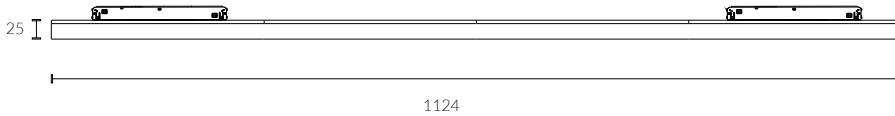

 Black Painted

IP Rating:	IP20
Optics:	30°/55°/65°/65°Extra Wide/Forward throwing
UGR:	<19
CRI:	92Ra
Lifetime:	>50,000 hrs (L70 B10)
CCT:	3000K
Typical Source Efficacy (lm/W):	113
Control:	On/off, 0/1-10V, Dali, Zigbee, Casambi
Binning	2 Step MacAdams
Voltage connection	48 VDC 21W
Luminous efficacy	1624 lm - 3000K
Ambient temp:	-20 °C to 45 °C
Class:	III



W system	Im system	optics	code
21W	1624	30°	MLBM21W-30N30-B
21W	1533	55°	MLBM21W-30N55-B
21W	1624	65°	MLBM21W-30N65-B
21W	1533	65°Extra Wide	MLBM21W-30N65E-B
21W	1456	Forward throwing	MLBM21W-30NFT-B

EVOLINE 48V

48V Light Stripe Fixed Version

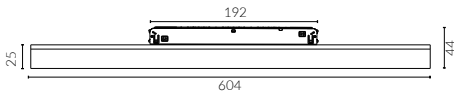
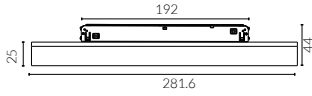

Black Painted



[view on website](#)

IP Rating:	IP20
Optics:	120°
UGR:	< 19
CRI:	92Ra
Lifetime:	>50,000 hrs (L70 B10)
CCT:	3000K/3500K/2700K-6000K
Typical Source	
Efficacy (lm/W):	113
Control:	On/off, 0/1-10V, Dali, Zigbee, Casambi
Binning	2 Step MacAdams
Input:	48 VDC
Output:	DC 36V 300mA 12W DC 36V 450mA 18W
Ambient temp:	-20 °C to 45 °C
Class:	III



W system	lm system	length	optics	code
12W	548	304	120°	M22DF12W-30N120-B
18W	822	604	120°	M22DF18W-30N120-B

EVOLINE 48V

48V Light Stripe Wall Wash



view on website

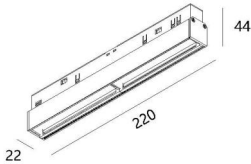

Black Painted



IP Rating:	IP20
Optics:	Wall Wash
UGR:	< 19
CRI:	92Ra
Lifetime:	>50,000 hrs (L70 B10)
CCT:	3000K
Typical Source	
Efficacy (lm/W):	113
Control:	On/off, 0/1-10V, Dali, Zigbee, Casambi
Binning	2 Step MacAdams
Input:	48 VDC
Output:	DC 21V 450mA 12W
Ambient temp:	-20 °C to 45 °C
Class:	III

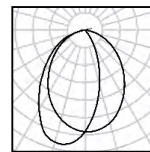

10W Ra92 3000K
Asymmetrical

h(m)	E(lx)	D(m)
0.5	210	0.95
1.0	53	1.89
1.5	23	2.84
2.0	13	3.78
2.5	8	4.75
3.0	6	5.67



W system	lm system	optics	code
12W	548	Wall Wash	M22WW12W-30NWS-B

GLAMO 48V

Φ68 Zoomable 15°-50° 48V Surface Downlight



view on website



Fixed Optic

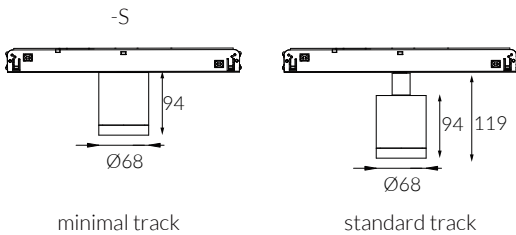

IP Rating: IP20
Optics: Zoomable 15°-50°
UGR: <17
CRI: 98Ra
Lifetime: >50,000 hrs (L70 B10)
CCT: 2700K/3000K/3500K/4000K/5000K/
 2000K-3000K/1800K-4000K/2700K-6000K

Typical Source Efficacy (lm/W): 113
Control: On/off, 0/1-10V, Dali, Zigbee, Casambi
Binning: 2 Step MacAdams
Input: 48 VDC
Output: DC 36V 150mA 6W
 DC 36V 200mA 8W
 DC 36V 250mA 10W
 DC 36V 300mA 12W

Ambient temp: -20 °C to 45 °C
Class: III
Material: structure fine aluminum 6063A

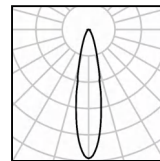

12W Ra98 3000K 15°

h(m)	E(lx)	D(m)
0.5	12099	0.14
1.0	3025	0.27
1.5	1344	0.41
2.0	756	0.54
2.5	484	0.68
3.0	336	0.81

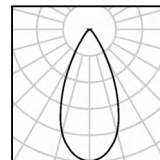

12W Ra98 3000K 40°

h(m)	E(lx)	D(m)
0.5	2174	0.38
1.0	544	0.76
1.5	242	1.14
2.0	136	1.52
2.5	87	1.90
3.0	60	2.28



W system	lm system	optics	code
6 W	437-433	15°- 50°	MS6806W-30N1550
8 W	623-544	15°- 50°	MS6808W-30N1550
10W	585-589	15°- 50°	MS6810W-30N1550
12W	756-747	15°- 50°	MS6812W-30N1550

EVOLINE 48V

67X64 48V Surface Downlight



view on website

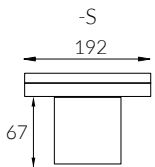
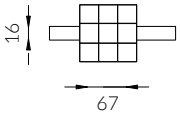

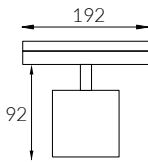

minimal track



standard track



Bezel

-  matt white painted
-  matt black painted

IP Rating:	IP20
Optics:	50°
UGR:	<17
CRI:	92Ra
Lifetime:	>50,000 hrs (L70 B10)
CCT:	3000K/3500K
Typical Source	
Efficacy (lm/W):	113
Control:	On/off, 0/1-10V, Dali, Zigbee, Casambi
Binning	2 Step MacAdams
Input:	48 VDC
Output:	DC 27V 300mA 8W
Ambient temp:	-20 °C to 45 °C
Class:	III
Material:	structure fine aluminum 6063A

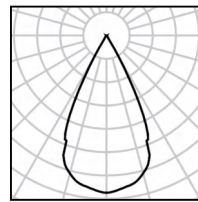

8W Ra92 3000K 50°

h(m)	E(lx)	D(m)
0.5	907	0.48
1.0	227	0.96
1.5	101	1.44
2.0	57	1.93
2.5	36	2.41
3.0	25	2.89

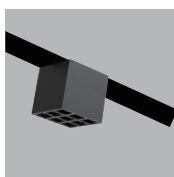

W system	lm system	optics	code
8W	458	50°	MSQ0908W-30N50

CUPOLA 48V

Φ114 48V Surface Downlight



[view on website](#)

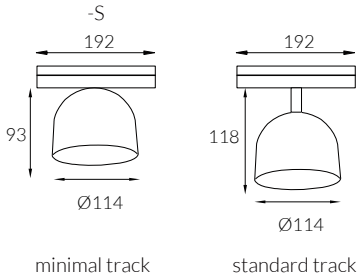

IP Rating:	IP20
Optics:	10°/24°/36°/55°
UGR:	< 10
CRI:	98Ra
Lifetime:	>50,000 hrs (L70 B10)
CCT:	2700K/3000K/3500K/4000K/5000K/2700K-6000K
Typical Source	
Efficacy (lm/W):	110
Control:	On/off, 0/1-10V, Dali, Zigbee, Casambi
Binning	2 Step MacAdams
Input:	48 VDC
Output:	DC 36V 150mA 6W DC 36V 200mA 8W
Ambient temp:	-20 C to 45 C
Class:	III



W system	lm system	optics	code
6W	376	10°	M22CUSSE11406W-30N10-B
6W	597	24°	M22CUSSE11406W-30N24-B
6W	590	36°	M22CUSSE11406W-30N36-B
6W	545	55°	M22CUSSE11406W-30N55-B

W system	lm system	optics	code
8W	445	10°	M22CUSSE11408W-30N10-B
8W	738	24°	M22CUSSE11408W-30N24-B
8W	736	36°	M22CUSSE11408W-30N36-B
8W	672	55°	M22CUSSE11408W-30N55-B

GLAMO 48V

Φ68 Zoomable 15°-50° 48V Pendant



view on website

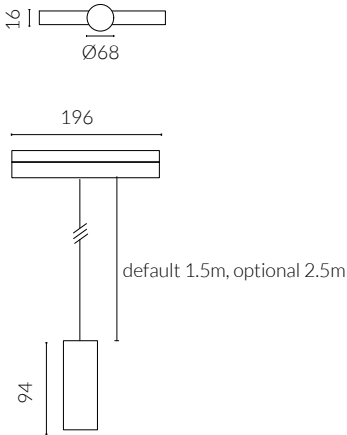

 Black Painted



- IP Rating:** IP20
- Optics:** Zoomable 15°-50°
- UGR:** <17
- CRI:** 98Ra
- Lifetime:** >50,000 hrs (L70 B10)
- CCT:** 2700K/3000K/3500K/4000K/5000K/
2000K-3000K/1800K-4000K/2700K-6000K

Typical Source

- Efficacy (lm/W):** 113
- Control:** On/off, 0/1-10V, Dali, Zigbee, Casambi
- Binning:** 2 Step MacAdams
- Input:** 48 VDC
- Output:** DC 36V 150mA 6W
DC 36V 200mA 8W
DC 36V 250mA 10W
DC 36V 300mA 12W

- Ambient temp:** -20 °C to 45 °C
- Class:** III
- Material:** structure fine aluminum 6063A

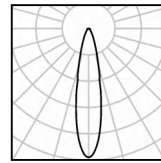

12W Ra98 3000K 15°

h(m)	E(lx)	D(m)
0.5	12099	0.14
1.0	3025	0.27
1.5	1344	0.41
2.0	756	0.54
2.5	484	0.68
3.0	336	0.81

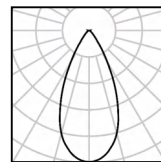

12W Ra98 3000K 40°

h(m)	E(lx)	D(m)
0.5	2174	0.38
1.0	544	0.76
1.5	242	1.14
2.0	136	1.52
2.5	87	1.90
3.0	60	2.28



W system	lm system	optics	code
6 W	437-433	15°- 50°	MPW6806W-30N1550
8 W	623-544	15°- 50°	MPW6808W-30N1550
10W	585-589	15°- 50°	MPW6810W-30N1550
12W	756-747	15°- 50°	MPW6812W-30N1550

EVOLINE 48V

67X64 48V Pendant



view on website

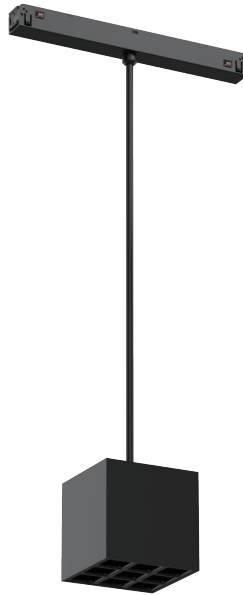
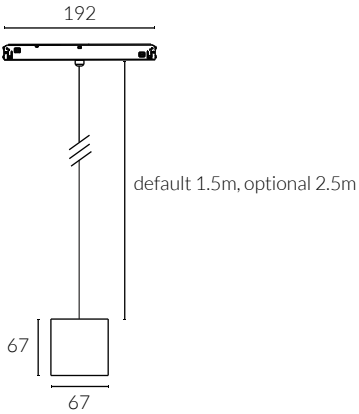

Bezel

-  matt white painted
-  matt black painted

- IP Rating:** IP20
- Optics:** 50°
- UGR:** <17
- CRI:** 92Ra
- Lifetime:** >50,000 hrs (L70 B10)
- CCT:** 3000K/3500K
- Typical Source**
- Efficacy (lm/W):** 113
- Control:** On/off, 0/1-10V, Dali, Zigbee, Casambi
- Binning** 2 Step MacAdams
- Input:** 48 VDC
- Output:** DC 27V 300mA 8W
- Ambient temp:** -20 °C to 45 °C
- Class:** III
- Material:** structure fine aluminum 6063A

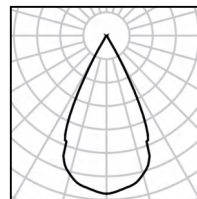

8W Ra92 3000K 50°

h(m)	E(lx)	D(m)
0.5	907	0.48
1.0	227	0.96
1.5	101	1.44
2.0	57	1.93
2.5	36	2.41
3.0	25	2.89

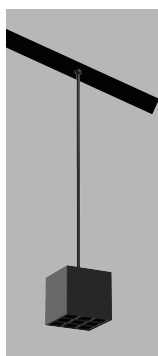

W system	lm system	optics	code
8W	458	50°	MPQ0908W-30N50

ORBIT 48V

Φ30 48V Pendant



view on website

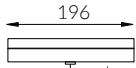
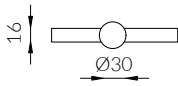

default 1.5m, optional 2.5m

495



-  White Painted
-  Black Painted



- IP Rating:** IP20
- Optics:** 15°/25°/30°/50°
- UGR:** <10
- CRI:** 92Ra
- Lifetime:** >50,000 hrs (L70 B10)
- CCT:** 2700K/3000K
- Typical Source**
- Efficacy (lm/W):** 113
- Control:** On/off, Mains Dim, 0/1-10V, Dali, Zigbee, Casambi
- Binning** 2 Step MacAdams
- Input:** 48 VDC
- Output:** DC 3V 300mA 1.3W
DC 3V 650mA 3W
- Ambient temp:** -20 °C to 45 °C
- Class:** III

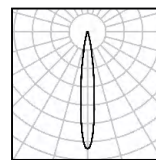

3W Ra92 3000K 15°

h(m)	E(lx)	D(m)
0.5	4168	0.11
1.0	1042	0.23
1.5	463	0.34
2.0	261	0.46
2.5	167	0.57
3.0	116	0.65

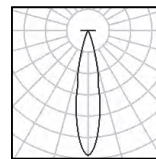

3W Ra92 3000K 25°

h(m)	E(lx)	D(m)
0.5	1872	0.18
1.0	468	0.36
1.5	208	0.55
2.0	117	0.73
2.5	75	0.91
3.0	52	1.09

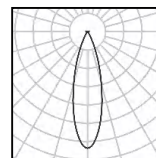

3W Ra92 3000K 30°

h(m)	E(lx)	D(m)
0.5	855	0.25
1.0	214	0.50
1.5	95	0.75
2.0	53	1.00
2.5	34	1.26
3.0	24	1.51



W system	lm system	optics	code
1.3W	68	15°	M22P301.3W-30N15-W
1.3W	79	25°	M22P301.3W-30N25-W
1.3W	85	30°	M22P301.3W-30N30-W
1.3W	82	50°	M22P301.3W-30N50-W



W system	lm system	optics	code
3W	148	15°	M22P3003W-30N15-W
3W	157	25°	M22P3003W-30N25-W
3W	179	30°	M22P3003W-30N30-W
3W	162	50°	M22P3003W-30N50-W

ORBIT 48V

Φ55
48V Pendant



view on website

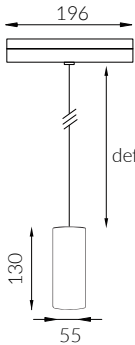
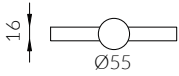

-  White Painted
-  Black Painted

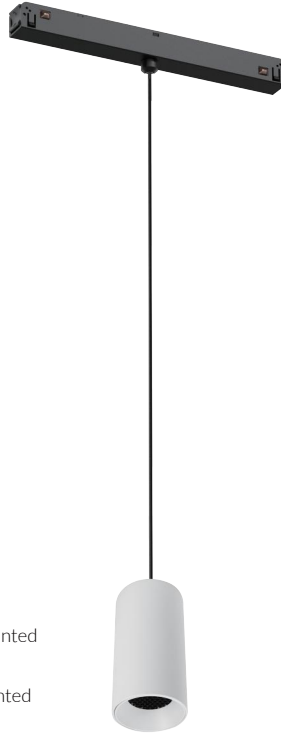

- IP Rating:** IP20
- Optics:** 12°/20°/30°/40°
- UGR:** < 10
- CRI:** 98Ra
- Lifetime:** > 50,000 hrs (L70 B10)
- CCT:** 2700K/3000K/3500K/4000K/5000K/
2000K-3000K/1800K-4000K/2700K-6000K
- Typical Source Efficacy (lm/W):** 113
- Control:** On/off, 0/1-10V, Dali, Zigbee, Casambi
- Binning:** 2 Step MacAdams
- Input:** 48 VDC
- Output:** DC 36V 250mA 10W
DC 36V 300mA 12W
DC 36V 350mA 15W
- Ambient temp:** -20 C to 45 C
- Class:** III

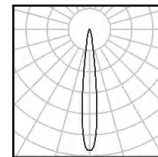

15W Ra98 3000K 12°

h(m)	E(lx)	D(m)
0.5	19862	0.11
1.0	4965	0.22
1.5	2207	0.33
2.0	1241	0.43
2.5	794	0.54
3.0	552	0.65

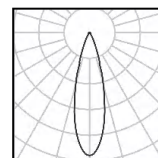

15W Ra98 3000K 20°

h(m)	E(lx)	D(m)
0.5	11574	0.18
1.0	2894	0.36
1.5	1286	0.54
2.0	723	0.72
2.5	463	0.90
3.0	322	1.08

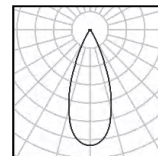

15W Ra98 3000K 30°

h(m)	E(lx)	D(m)
0.5	6165	0.27
1.0	1541	0.54
1.5	685	0.80
2.0	385	1.07
2.5	247	1.34
3.0	171	1.61

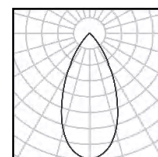

15W Ra98 3000K 40°

h(m)	E(lx)	D(m)
0.5	2648	0.38
1.0	662	0.76
1.5	294	1.15
2.0	166	1.53
2.5	106	1.91
3.0	74	2.29

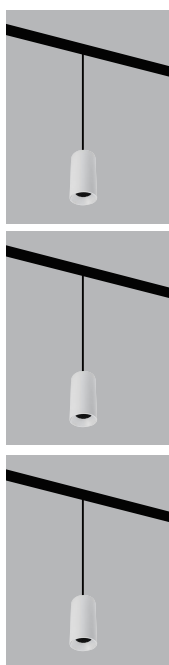

W system	lm system	optics	code
10W	639	12°	M22P5510W-30N12-B
10W	684	20°	M22P5510W-30N20-B
10W	738	30°	M22P5510W-30N30-B
10W	700	40°	M22P5510W-30N40-B

W system	lm system	optics	code
12W	747	12°	M22P5512W-30N12-B
12W	749	20°	M22P5512W-30N20-B
12W	803	30°	M22P5512W-30N30-B
12W	760	40°	M22P5512W-30N40-B

W system	lm system	optics	code
15W	808	12°	M22P5515W-30N12-B
15W	896	20°	M22P5515W-30N20-B
15W	956	30°	M22P5515W-30N30-B
15W	906	40°	M22P5515W-30N40-B

HALO 48V

Φ50 48V Pendant



[view on website](#)

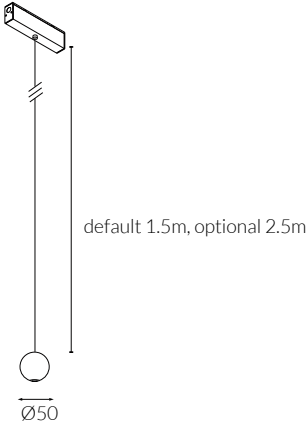

Ceiling hook to move light point

 Anodized Grey

IP Rating:	IP20
Optics:	15°/25°/30°/50°/60°
UGR:	<10
CRI:	92Ra
Lifetime:	>50,000 hrs (L70 B10)
CCT:	2700K/3000K/3500K/4000K/5000K
Typical Source	
Efficacy (lm/W):	113
Control:	On/off, 0/1-10V, Dali, Zigbee, Casambi
Binning	2 Step MacAdams
Input:	48 VDC
Output:	DC 3V 650mA 3W
Ambient temp:	-20 °C to 45 °C
Class:	III

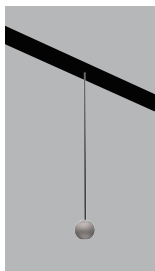

W system	lm system	optics	code
3W	148	15°	M22S5003W-30N15-SG
3W	157	25°	M22S5003W-30N25-SG
3W	179	30°	M22S5003W-30N30-SG
3W	162	50°	M22S5003W-30N50-SG
3W	159	60°	M22S5003W-30N60-SG

ACME 48V

Φ57 Engine 48V Pendant



Fixed Optic

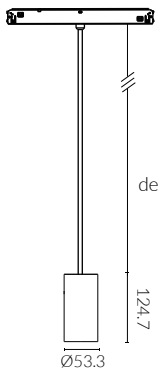

default 1.5m, optional 2.5m

124.7

Ø53.3



bespoke
Faceted
Brass

optional curve baffle



view on website

-  White Painted
-  Black Painted
-  Antique Bronze
-  Brushed Grey
-  Solid Brass
-  Faceted Brass

- IP Rating:** IP20 and IP44 options
- Optics:** 15°/24°/36°
- UGR:** <10
- CRI:** 98Ra
- Lifetime:** >50,000 hrs (L70 B10)
- CCT:** 2700K/3000K/3500K/4000K/
5000K/2000K-3000K/1800K-4000K/2700K-6000K

- Typical Source**
- Efficacy (lm/W):** 110
- Control:** On/off, 0/1-10V, Dali, Zigbee, Casambi
- Binning** 2 Step MacAdams
- Input:** 48 VDC
- Output:** DC 36V 250mA 10W
- Ambient temp:** -20 °C to 45 °C
- Class:** III
- Optional accessories:** Honeycomb louvre, Solite Lense, Spread Lense, Colour Filter
- Material:** Fine aluminium 6063A

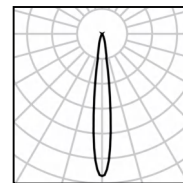

10W Ra98 3000K 15°

h(m)	E(lx)	D(m)
0.5	10728	0.15
1.0	2682	0.31
1.5	1192	0.46
2.0	671	0.61
2.5	429	0.77
3.0	298	0.92

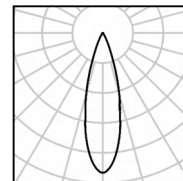

10W Ra98 3000K 24°

h(m)	E(lx)	D(m)
0.5	7580	0.21
1.0	1895	0.42
1.5	842	0.63
2.0	474	0.84
2.5	303	1.04
3.0	211	1.25

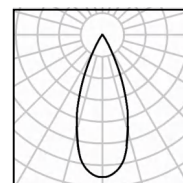

10W Ra98 3000K 36°

h(m)	E(lx)	D(m)
0.5	4206	0.28
1.0	1051	0.57
1.5	467	0.85
2.0	263	1.14
2.5	168	1.42
3.0	117	1.71

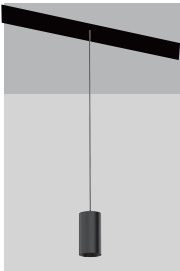

W system	lm system	optics	code
10W	462	15°	MPWE5710W-30N15-B
10W	628	24°	MPWE5710W-30N24-B
10W	616	36°	MPWE5710W-30N36-B

ACME 48V

Φ68 Engine 48V Pendant



view on website





Fixed Optic



default 1.5m, optional 2.5m



-  White Painted
-  Black Painted
-  Antique Bronze
-  Brushed Grey

- IP Rating:** IP20 and IP44 options
- Optics:** 15°/24°/36°/50°
- UGR:** <10
- CRI:** 98Ra
- Lifetime:** >50,000 hrs (L70 B10)
- CCT:** 2700K/3000K/3500K/4000K/5000K/
2000K-3000K/1800K-4000K/2700K-6000K
- Typical Source**
- Efficacy (lm/W):** 110
- Control:** On/off, 0/1-10V, Dali, Zigbee, Casambi
- Binning** 2 Step MacAdams
- Input:** 48 VDC
- Output:** DC 36V 300mA 12W
- Ambient temp:** -20 °C to 45 °C
- Class:** III
- Optional accessories:** Honeycomb louvre, Solite Lense, Spread Lense, Colour Filter
- Material:** Fine aluminium 6063A

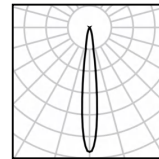

12W Ra98 3000K 15°

h(m)	E(lx)	D(m)
0.5	10897	0.17
1.0	2724	0.33
1.5	1211	0.50
2.0	681	0.66
2.5	436	0.83
3.0	303	0.99

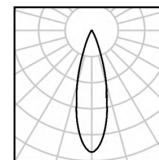

12W Ra98 3000K 24°

h(m)	E(lx)	D(m)
0.5	8621	0.20
1.0	2155	0.41
1.5	958	0.61
2.0	539	0.81
2.5	345	1.02
3.0	239	1.22

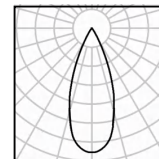

12W Ra98 3000K 36°

h(m)	E(lx)	D(m)
0.5	4792	0.28
1.0	1198	0.55
1.5	532	0.83
2.0	300	1.10
2.5	192	1.38
3.0	133	1.65

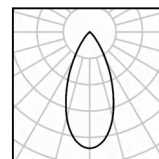

12W Ra98 3000K 50°

h(m)	E(lx)	D(m)
0.5	1608	0.47
1.0	402	0.93
1.5	179	1.40
2.0	100	1.87
2.5	64	2.33
3.0	45	2.80

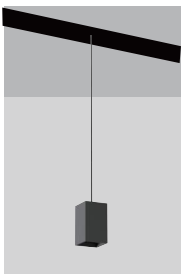

W system	lm system	optics	code
12W	717	15°	MPWQE6812W-30N15-B
12W	760	24°	MPWQE6812W-30N24-B
12W	750	36°	MPWQE6812W-30N36-B
12W	640	50°	MPWQE6812W-30N50-B

ACME 48V

Φ50 Engine 48V Pendant



view on website



Fixed Optic

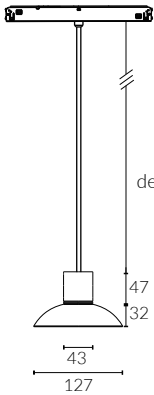

default 1.5m, optional 2.5m

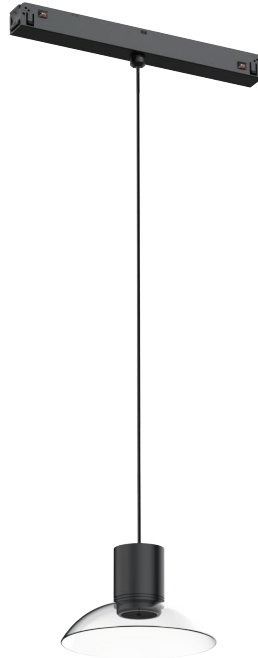

Engine



Black

Glass



Smoke Grey

IP Rating:	IP20 and IP44 options
Optics:	15°/24°/36°
UGR:	<10
CRI:	98Ra
Lifetime:	>50,000 hrs (L70 B10)
CCT:	2700K/3000K/3500K/4000K/5000K/ 2000K-3000K/1800K-4000K/2700K-6000K
Typical Source	
Efficacy (lm/W):	110
Control:	On/off, 0/1-10V, Dali, Zigbee, Casambi
Binning	2 Step MacAdams
Input:	48 VDC
Output:	DC 36V 200mA 8W
Ambient temp:	-20 °C to 45 °C
Class:	III

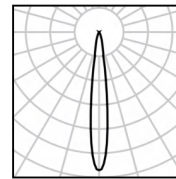

8W Ra98 3000K 15°

h(m)	E(lx)	D(m)
0.5	7204	0.11
1.0	1801	0.22
1.5	800	0.33
2.0	450	0.43
2.5	288	0.54
3.0	200	0.65

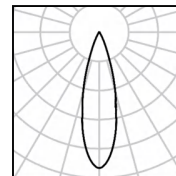

8W Ra98 3000K 24°

h(m)	E(lx)	D(m)
0.5	2613	0.25
1.0	653	0.49
1.5	290	0.74
2.0	163	0.99
2.5	105	1.24
3.0	73	1.48

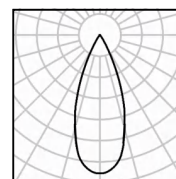

8W Ra98 3000K 36°

h(m)	E(lx)	D(m)
0.5	2005	0.34
1.0	501	0.68
1.5	223	1.03
2.0	125	1.37
2.5	80	1.71
3.0	56	2.05



DuraGreen project:
Luxury Home

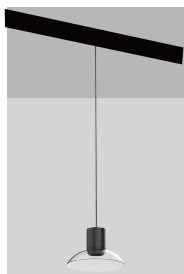

W system	lm system	optics	code
8W	336	15°	MPWGE5008W-30N15-B
8W	381	24°	MPWGE5008W-30N24-B
8W	453	36°	MPWGE5008W-30N36-B

ACME 48V

Φ68 Engine 48V Pendant



Fixed Optic



default 1.5m, optional 2.5m

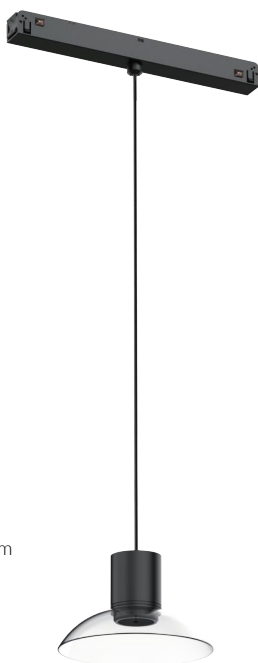

bespokeable 340°
omnidirectional



view on website

Engine



Black

Glass



Smoke grey

IP Rating:	IP20 and IP44 options
Optics:	15°/24°/36°/50°/340°
UGR:	<10
CRI:	98Ra
Lifetime:	>50,000 hrs (L70 B10)
CCT:	2700K/3000K/3500K/4000K/5000K/ 2000K-3000K/1800K-4000K/2700K-6000K

Typical Source

Efficacy (lm/W): 110

Control: On/off, 0/1-10V, Dali, Zigbee, Casambi

Binning 2 Step MacAdams

Input: 48 VDC

Output: DC 36V 300mA 12W

Ambient temp: -20 °C to 45 °C

Class: III

Optional accessories: Honeycomb louvre, Solite Lense, Spread Lense, Colour Filter

Material: Fine aluminium 6063A, Glass

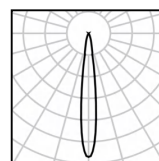

12W Ra98 3000K 15°

h(m)	E(lx)	D(m)
0.5	10897	0.17
1.0	2724	0.33
1.5	1211	0.50
2.0	681	0.66
2.5	436	0.83
3.0	303	0.99

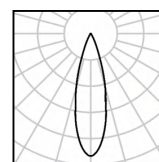

12W Ra98 3000K 24°

h(m)	E(lx)	D(m)
0.5	8621	0.20
1.0	2155	0.41
1.5	958	0.61
2.0	539	0.81
2.5	345	1.02
3.0	239	1.22

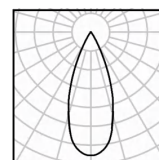

12W Ra98 3000K 36°

h(m)	E(lx)	D(m)
0.5	4792	0.28
1.0	1198	0.55
1.5	532	0.83
2.0	300	1.10
2.5	192	1.38
3.0	133	1.65

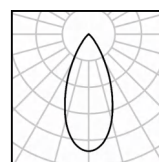

12W Ra98 3000K 50°

h(m)	E(lx)	D(m)
0.5	1608	0.47
1.0	402	0.93
1.5	179	1.40
2.0	100	1.87
2.5	64	2.33
3.0	45	2.80

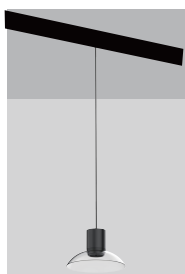
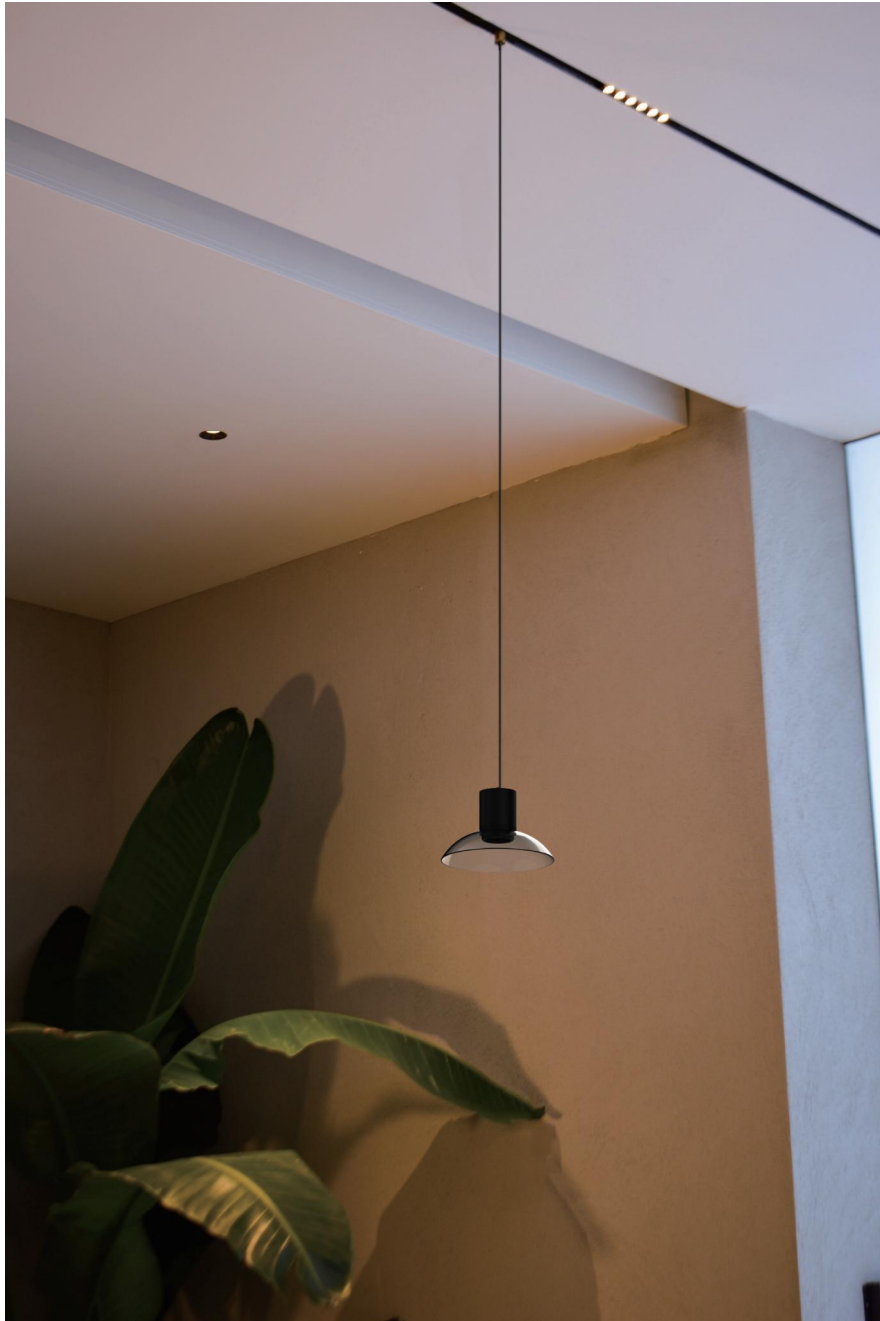

W system	lm system	optics	code
12W	717	15°	MPWGE6812W-30N15-B
12W	760	24°	MPWGE6812W-30N24-B
12W	750	36°	MPWGE6812W-30N36-B
12W	640	50°	MPWGE6812W-30N50-B
12W	650	340°	MPWGE6812W-30N340-B

CAPRI 48V

Φ114



Ceiling hook to move light point

-  White Painted
-  Black Painted



default 1.5m, optional 2.5m

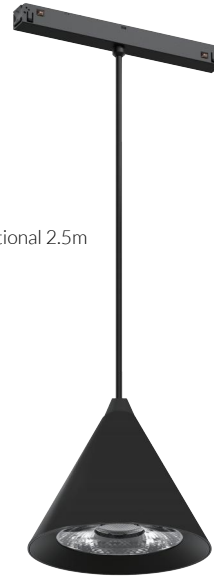

view on website

Fixed Pendant

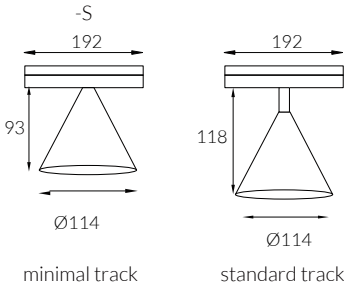

view on website

Surface Downlight

IP Rating:	IP20
Optics:	10°/24°/36°/55°
UGR:	<10
CRI:	98Ra
Lifetime:	>50,000 hrs (L70 B10)
CCT:	2700K/3000K/3500K/4000K/5000K/2700K-6000K
Typical Source	
Efficacy (lm/W):	110
Control:	On/off, 0/1-10V, Dali, Zigbee, Casambi
Binning	2 Step MacAdams
Input:	48 VDC
Output:	DC 36V 150mA 6W DC 36V 200mA 8W
Ambient temp:	-20 °C to 45 °C
Class:	III



W system	lm system	optics	code
8W	445	10°	M22ST11408W-30N10-B
8W	738	24°	M22ST11408W-30N24-B
8W	736	36°	M22ST11408W-30N36-B
8W	672	55°	M22ST11408W-30N55-B

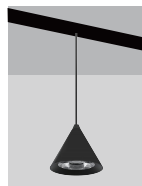

W system	lm system	optics	code
8W	445	10°	M22T11408W-30N10-SG
8W	738	24°	M22T11408W-30N24-SG
8W	736	36°	M22T11408W-30N36-SG
8W	672	55°	M22T11408W-30N55-SG

BELLA 48V

Φ41 Zoomable 20°-50° 48V Pendant



[view on website](#)

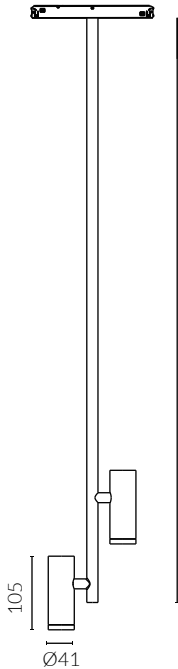

877 pole length bespokable

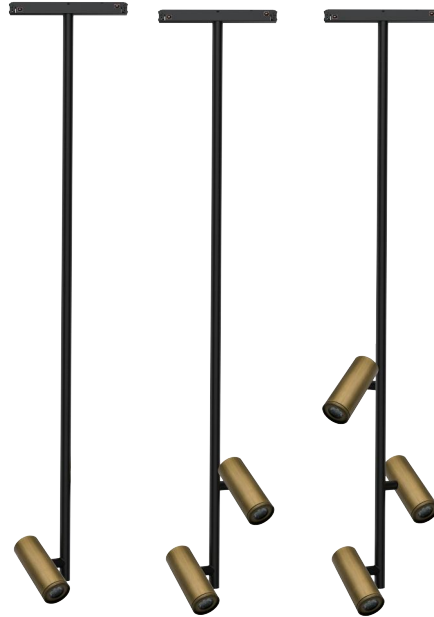

Antique Bronze

IP Rating:	IP20
Optics:	Zoomable 20°-50°
UGR:	<17
CRI:	92Ra
Lifetime:	>50,000 hrs (L70 B10)
CCT:	3000K/3500K/2700-6000K
Typical Source Efficacy (lm/W):	96
Control:	On/off, 0/1-10V, Dali, Zigbee, Casambi
Binning	2 Step MacAdams
Input:	48VDC
Output:	DC 12V 600mA 8W
Ambient temp:	-20 C to 45 C
Class:	III
Material:	structure fine aluminum 6063A

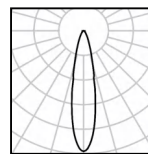

8W Ra92 3000K 20°

h(m)	E lx	D(m)
0.5	2978	0.21
1.0	745	0.42
1.5	331	0.63
2.0	186	0.84
2.5	119	1.04
3.0	83	1.25

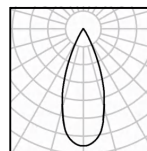

8W Ra92 3000K 30°

h(m)	E lx	D(m)
0.5	1805	0.30
1.0	451	0.59
1.5	201	0.89
2.0	113	1.18
2.5	72	1.48
3.0	50	1.78

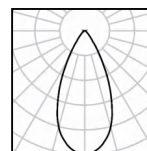

8W Ra92 3000K 50°

h(m)	E lx	D(m)
0.5	795	0.49
1.0	199	0.97
1.5	88	1.46
2.0	50	1.94
2.5	32	2.43
3.0	22	2.91

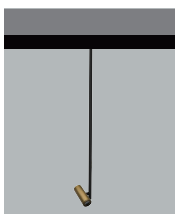

W system	Spots	lm system	optics	code
8W	1 Spot	388- 385	20°- 50°	MP14108WX1-30N2050-AB

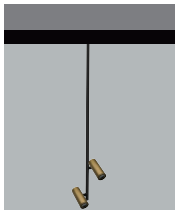

W system	Spots	lm system	optics	code
8W*2	2 Spot	388*2-385*2	20°- 50°	MP24108WX2-30N2050-AB

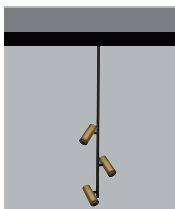

W system	Spots	lm system	optics	code
8W*3	3 Spot	388*3-385*3	20°- 50°	MP34108WX3-30N2050-AB

BELLA 48V

Φ41 Zoomable 20°-50° 48V Pendant





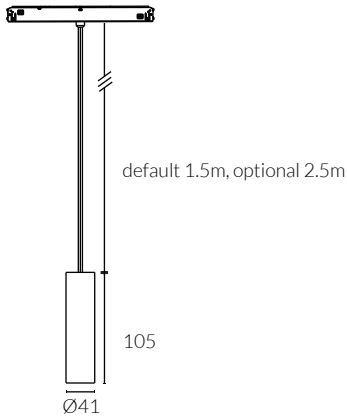

view on website

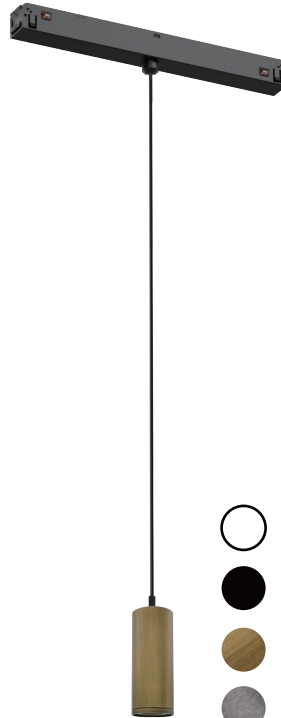

Ceiling hook to move light point



-  White Painted
-  Black Painted
-  Antique Bronze
-  Brushed Grey

- IP Rating:** IP20
- Optics:** Zoomable 20°-50°
- UGR:** <17
- CRI:** 92Ra
- Lifetime:** >50,000 hrs (L70 B10)
- CCT:** 3000K/3500K/2700-6000K
- Typical Source**
- Efficacy (lm/W):** 96
- Control:** On/off, 0/1-10V, Dali, Zigbee, Casambi
- Binning:** 2 Step MacAdams
- Input:** 48 VDC
- Output:** 12V 600mA 8W
- Ambient temp:** -20 °C to 45 °C
- Class:** III
- Material:** structure fine aluminum 6063A

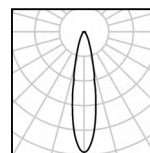

8W Ra92 3000K 20°

h(m)	E(lx)	D(m)
0.5	2978	0.21
1.0	745	0.42
1.5	331	0.63
2.0	186	0.84
2.5	119	1.04
3.0	83	1.25

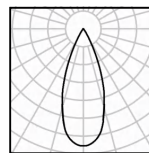

8W Ra92 3000K 30°

h(m)	E(lx)	D(m)
0.5	1805	0.30
1.0	451	0.59
1.5	201	0.89
2.0	113	1.18
2.5	72	1.48
3.0	50	1.78

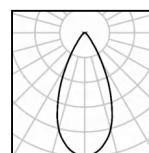

8W Ra92 3000K 50°

h(m)	E(lx)	D(m)
0.5	795	0.49
1.0	199	0.97
1.5	88	1.46
2.0	50	1.94
2.5	32	2.43
3.0	22	2.91

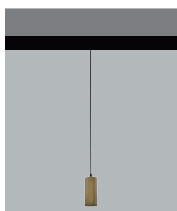

W system	lm system	optics	code
8W	388-385	20°- 50°	MPW4108W-30N2050-AB

EVOLINE 48V

1124mm
48V Pendant



[view on website](#)

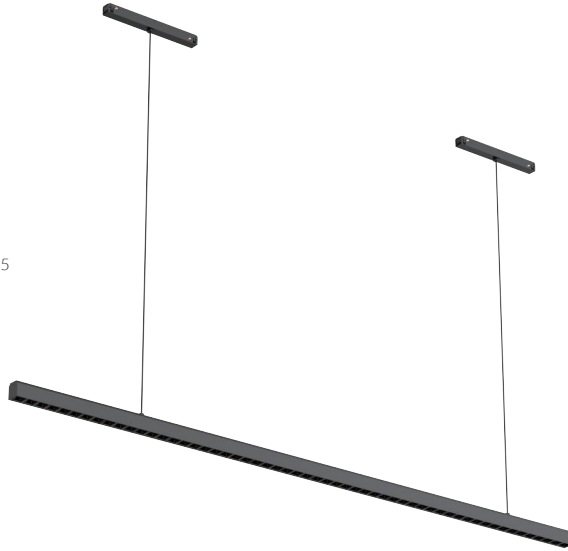
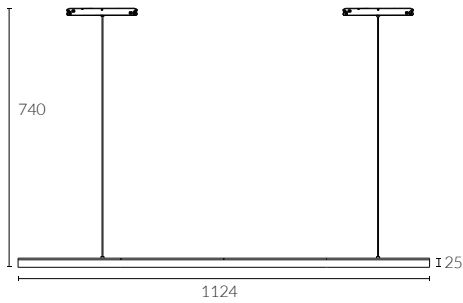

 Black Painted

IP Rating:	IP20
Optics:	30°/55°/65°/65°Extra Wide/Forward throwing
UGR:	<19
CRI:	92Ra
Lifetime:	>50,000 hrs (L70 B10)
CCT:	3000K
Typical Source	
Efficacy (lm/W):	113
Control:	On/off, 0/1-10V, Dali, Zigbee, Casambi
Binning	2 Step MacAdams
Voltage connection	48 VDC 21W
Luminous efficacy	1624 lm - 3000K
Ambient temp:	-20 °C to 45 °C
Class:	III

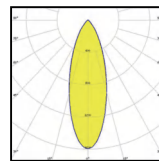

30°

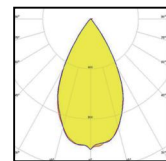

55°

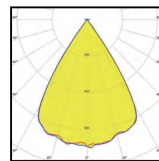

65°

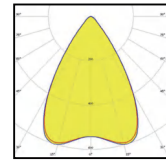

65° Extra Wide

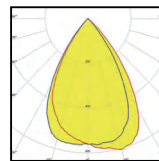

Forward throwing

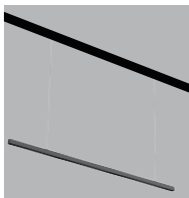

W system	Im system	optics	code
21W	1624	30°	M22P112421W-30N30-B
21W	1533	55°	M22P112421W-30N55-B
21W	1624	65°	M22P112421W-30N65-B
21W	1533	65°Extra Wide	M22P112421W-30N65E-B
21W	1456	Forward throwing	M22P112421W-30NFT-B

TRACK 220-240V

Global compatible track adaptors

TRACK 1L / TRACK 3L / TRACK 3L - DIM /

BELLA / GLAMO / ARTFOCUS / ORBIT /



DuraGreen project:
YELLOWKORNER Art Gallery

TRACK 1L

SURFACE & SUSPENDED



view on website

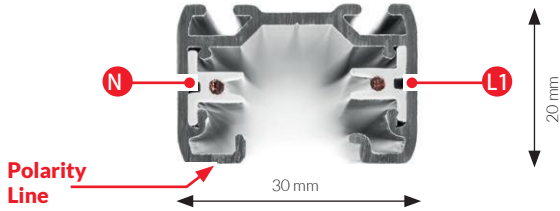

Type	Code
TRACK 1L 1m	GB2100- B W
TRACK 1L 2m	GB2200- B W
TRACK 1L 3m	GB2300- B W

FLUSH MOUNTING



view on website

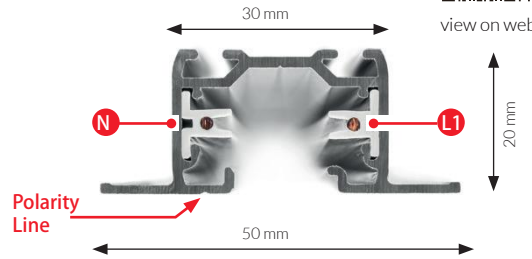

Type	Code
TRACK 1L 1m	GBF2100- B W
TRACK 1L 2m	GBF2200- B W
TRACK 1L 3m	GBF2300- B W

End feed

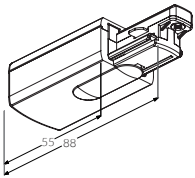

POLARITY GROOVE	Code
	GB11- B W
	GB12- B W

L-feed

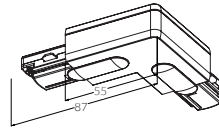

POLARITY GROOVE	Code
	GB34- B W
	GB35- B W

T-feed

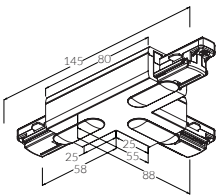

POLARITY GROOVE	Code
	GB36- B W
	GB37- B W
	GB39- B W
	GB40- B W

X-feed

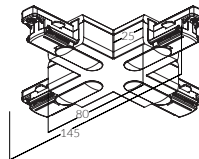

POLARITY GROOVE	Code
	GB38- B W

Middle feed

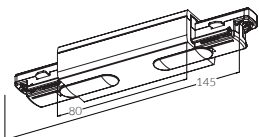

Code
GB14- B W

Straight Connecto

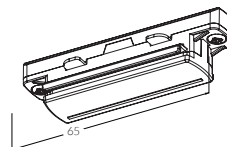

Code
GB21- B W

Adjustable corner connector

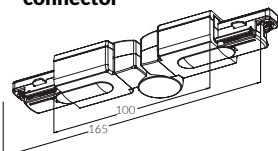

Code
GB24- B W

End cap

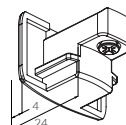

Code
GB41- B W

TRACK 3L

SURFACE & SUSPENDED



view on website

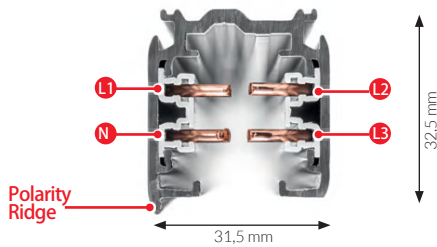

Type	Code
TRACK 3L 1m	XTS4100- B W
TRACK 3L 2m	XTS4200- B W
TRACK 3L 3m	XTS4300- B W

FLUSH MOUNTING



view on website

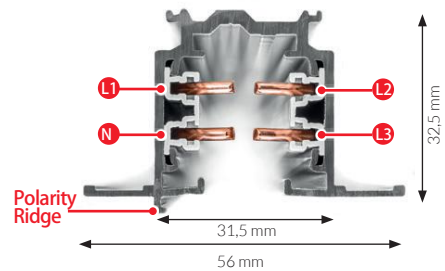

Type	Code
TRACK 3L 1m	XTSF4100- B W
TRACK 3L 2m	XTSF4200- B W
TRACK 3L 3m	XTSF4300- B W

End feed

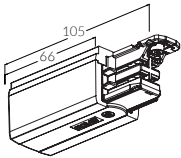

POLARITY GROOVE	Code
	XTS11- B W
	XTS12- B W

L-feed

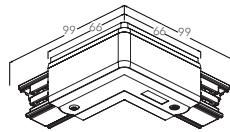

POLARITY GROOVE	Code
	XTS34- B W
	XTS35- B W

T-feed

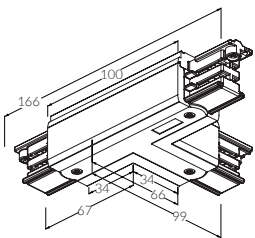

POLARITY GROOVE	Code
	XTS36- B W
	XTS37- B W
	XTS39- B W
	XTS40- B W

X-feed

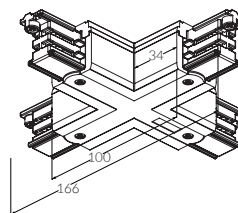

POLARITY GROOVE	Code
	XTS38- B W

Middle feed

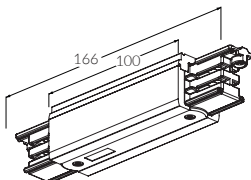

Code
XTS14- B W

Straight Connecto

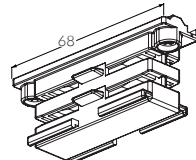

Code
XTS21- B W

Adjustable corner connector

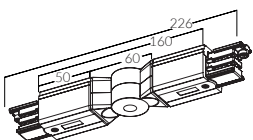

Code
XTS24- B W

Flexible corner connector

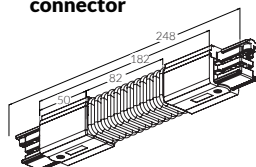

Code
XTS23- B W

End cap

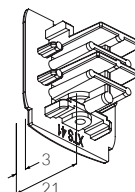

Code
XTS41- B W

TRACK 3L - DIM

SURFACE & SUSPENDED



view on website

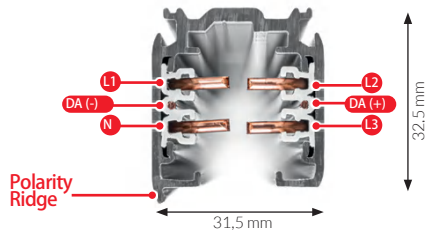

Type	Code
TRACK 3L 1m	XTSC6100- B W
TRACK 3L 2m	XTSC6200- B W
TRACK 3L 3m	XTSC6300- B W

FLUSH MOUNTING



view on website

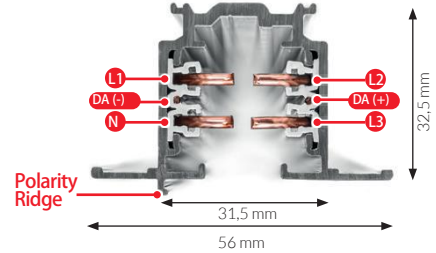

Type	Code
TRACK 3L 1m	XTSCF6100- B W
TRACK 3L 2m	XTSCF6200- B W
TRACK 3L 3m	XTSCF6300- B W

End feed

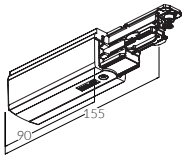

POLARITY GROOVE	Code
	XTSC611- B W
	XTSC612- B W

L-feed

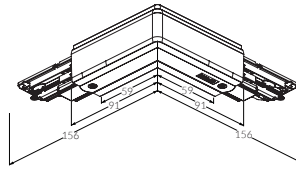

POLARITY GROOVE	Code
	XTSN634- B W
	XTSN635- B W

T-feed

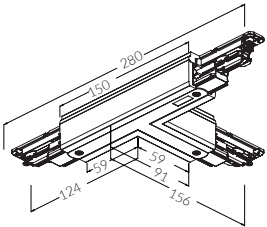

POLARITY GROOVE	Code
	XTSN636- B W
	XTSN637- B W
	XTSN639- B W
	XTSN640- B W

X-feed

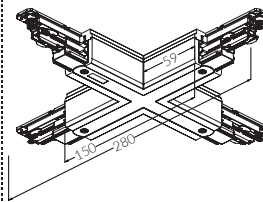

POLARITY GROOVE	Code
	XTSN638- B W

Middle feed

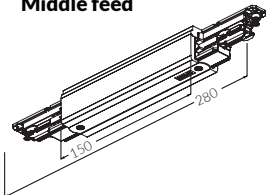

Code
XTSN614- B W

Straight Connecto

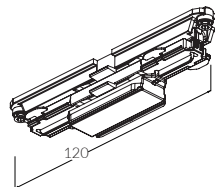

Code
XTSC621- B W

Flexible corner connector

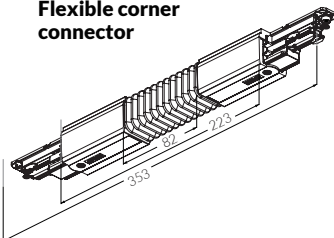

Code
XTSC623- B W

End cap

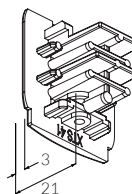

Code
XTS41- B W

BELLA

Φ41 Adjustable 220-240V~ Zoomable 20°-50° Track Light







view on website

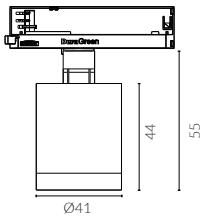

Adjustable Optic



-  White Painted
-  Black Painted
-  Antique Bronze
-  Brushed Grey



- IP Rating:** IP20
- Optics:** Zoomable 20°-50°
- UGR:** <17
- CRI:** 92Ra
- Lifetime:** >50,000 hrs (L70 B10)
- CCT:** 3000K/3500K/2700-6000K
- Typical Source Efficacy (lm/W):** 96
- Control:** On/off, Mains Dim, 0/1-10V, Dali, Zigbee, Casambi
- Binning:** 2 Step MacAdams
- Input:** AC220-240V 50/60Hz
- Output:** DC 12V 350mA 6W
- Ambient temp:** -20 °C to 45 °C
- Class:** II
- Material:** structure fine aluminum 6063A

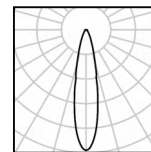

6W Ra92 3000K 30°

h(m)	E(lx)	D(m)
0.5	2355	0.20
1.0	589	0.40
1.5	262	0.59
2.0	147	0.79
2.5	94	0.99
3.0	65	1.19

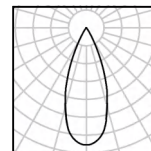

6W Ra92 3000K 30°

h(m)	E(lx)	D(m)
0.5	1378	0.29
1.0	344	0.58
1.5	153	0.88
2.0	86	1.17
2.5	55	1.46
3.0	38	1.75

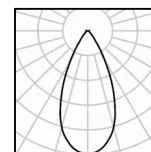

6W Ra92 3000K 50°

h(m)	E(lx)	D(m)
0.5	616	0.47
1.0	154	0.95
1.5	68	1.42
2.0	38	1.90
2.5	25	2.37
3.0	17	2.85



DuraGreen project:
Bravo Art Gallery



W system	lm system	optics	code
6W	292-296	20°- 50°	TK4106W-30N2050-B

Φ68 Adjustable 220-240V~ Zoomable 15°-50° Track Light



view on website



Adjustable Optic

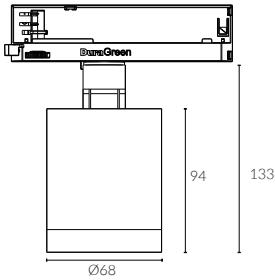

 Black Painted

IP Rating:	IP20
Optics:	Zoomable 15°-50°
UGR:	<17
CRI:	98Ra
Lifetime:	>50,000 hrs (L70 B10)
CCT:	2700K/3000K/3500K/4000K/5000K/ 2000K-3000K/1800K-4000K/2700K-6000K

Typical Source	
Efficacy (lm/W):	110
Control:	On/off, Mains Dim, 0/1-10V, Dali, Zigbee, Casambi
Binning:	2 Step MacAdams
Input:	AC220-240V 50/60Hz
Output:	DC 36V 150mA 6W DC 36V 200mA 8W DC 36V 250mA 10W DC 36V 300mA 12W
Ambient temp:	-20 C to 45 C
Class:	II
Material:	structure fine aluminum 6063A

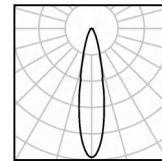

12W Ra98 3000K 15°

h(m)	E lx	D(m)
0.5	12099	0.14
1.0	3025	0.27
1.5	1344	0.41
2.0	756	0.54
2.5	484	0.68
3.0	336	0.81

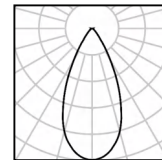

12W Ra98 3000K 40°

h(m)	E lx	D(m)
0.5	2174	0.38
1.0	544	0.76
1.5	242	1.14
2.0	136	1.52
2.5	87	1.90
3.0	60	2.28



DuraGreen project:
algebraist Coffee



W system	lm system	optics	code
6 W	437-433	15°- 50°	TK6806W-30N1550
8 W	623-544	15°- 50°	TK6808W-30N1550
10W	585-589	15°- 50°	TK6810W-30N1550
12W	756-747	15°- 50°	TK6812W-30N1550

GLAMO

Φ68 Adjustable 220-240V~ Contour Track Light



view on website



Adjustable Optic



Black Painted

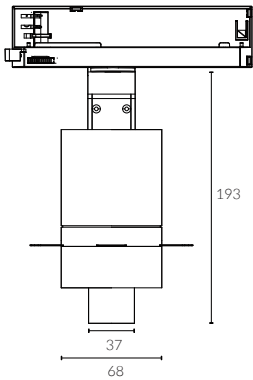

Contour spotlight illuminates art with defined beam

IP Rating:	IP20
Optics:	Framing
UGR:	<10
CRI:	98Ra
Lifetime:	>50,000 hrs (L70 B10)
CCT:	2700K/3000K/3500K/4000K/5000K/ 2000K-3000K/1800K-4000K/2700K-6000K

Typical Source	110
Efficacy (lm/W):	110
Control:	On/off, Mains Dim, 0/1-10V, Dali, Zigbee, Casambi
Binning:	2 Step MacAdams
Input:	AC220-240V 50/60Hz
Output:	DC 36V 250mA 10W
Ambient temp:	-20 °C to 45 °C
Class:	II
Material:	structure fine aluminum 6063A

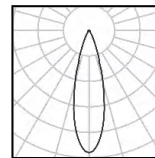

10W Ra98 3000K 24°

h(m)	E lx	D(m)
0.5	3216	0.21
1.0	804	0.42
1.5	357	0.63
2.0	201	0.84
2.5	129	1.04
3.0	89	1.25



DuraGreen project:
Illumination Showcase at Shenzhen Creative Week



W system	lm system	code
10W	239	TC6810W

ARTFOCUS

Φ36 Adjustable Round 220-240V~ Track Light



view on website



Adjustable Optic

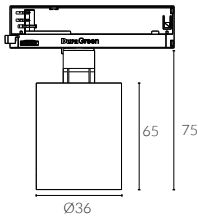

- IP Rating:** IP20 and IP44 options
- Optics:** 15°/28°/36°
- UGR:** <10
- CRI:** 98Ra
- Lifetime:** >50,000 hrs (L70 B10)
- CCT:** 2700K/3000K/3500K/4000K/5000K/
2000K-3000K/1800K-4000K/2700K-6000K

- Typical Source**
- Efficacy (lm/W):** 110
- Control:** On/off, Mains Dim, 0/1-10V, Dali, Zigbee, Casambi
- Binning** 2 Step MacAdams
- Input:** AC220-240V 50/60Hz
- Output:** DC 36V 150mA 6W
- Ambient temp:** -20 °C to 45 °C
- Class:** II
- Material:** structure fine aluminum 6063A

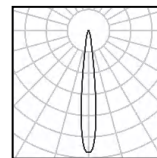

6W Ra98 3000K 15°

h(m)	E(lx)	D(m)
0.5	4937	0.14
1.0	1234	0.27
1.5	549	0.41
2.0	309	0.54
2.5	197	0.68
3.0	137	0.81

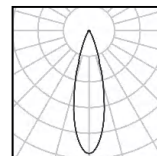

6W Ra98 3000K 28°

h(m)	E(lx)	D(m)
0.5	2848	0.25
1.0	712	0.49
1.5	316	0.74
2.0	178	0.98
2.5	114	1.23
3.0	79	1.47

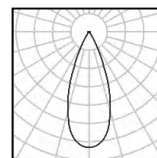

6W Ra98 3000K 36°

h(m)	E(lx)	D(m)
0.5	1706	0.31
1.0	426	0.62
1.5	190	0.93
2.0	107	1.25
2.5	68	1.56
3.0	47	1.87



DuraGreen project:
DuraGreen Showroom



W system	lm system	optics	code
6W	373	15°	MT3606W-30N15-B
6W	445	28°	MT3606W-30N28-B
6W	446	36°	MT3606W-30N36-B

ORBIT

Φ35 Adjustable Round 220-240V~ Track Light



view on website



Adjustable Optic

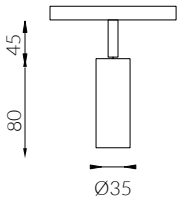

IP Rating:	IP20
Optics:	15°/30°/40°/55°
UGR:	<10
CRI:	98Ra
Lifetime:	>50,000 hrs (L70 B10)
CCT:	2700K/3000K
Typical Source Efficacy (lm/W):	110
Control:	On/off, Mains Dim, 0/1-10V, Dali, Zigbee, Casambi
Binning	2 Step MacAdams
Input:	AC220-240V 50/60Hz
Output:	DC 36V 150mA 6W
Ambient temp:	-20 °C to 45 °C
Class:	II
Optional accessories:	Honeycomb louvre, Solite Lense, Spread Lense, Colour Filter

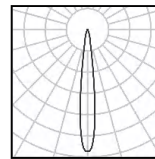

6W Ra98 3000K 15°

h(m)	E(lx)	D(m)
0.5	4391	0.14
1.0	1098	0.27
1.5	488	0.41
2.0	274	0.55
2.5	176	0.68
3.0	122	0.82

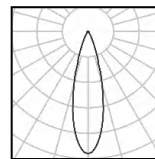

6W Ra98 3000K 30°

h(m)	E(lx)	D(m)
0.5	2085	0.28
1.0	521	0.55
1.5	232	0.83
2.0	130	1.10
2.5	83	1.38
3.0	58	1.65

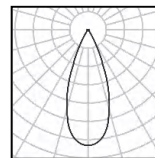

6W Ra98 3000K 40°

h(m)	E(lx)	D(m)
0.5	1572	0.38
1.0	393	0.76
1.5	175	1.15
2.0	98	1.53
2.5	63	1.91
3.0	44	2.29

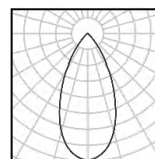

6W Ra98 3000K 55°

h(m)	E(lx)	D(m)
0.5	707	0.53
1.0	177	1.07
1.5	79	1.60
2.0	44	2.14
2.5	28	2.67
3.0	20	3.20



DuraGreen project:
VERSACE Showroom



W system	lm system	optics	code
6W	267	15°	MATL3506W-30N15-B
6W	353	30°	MATL3506W-30N30-B
6W	430	40°	MATL3506W-30N40-B
6W	415	55°	MATL3506W-30N55-B

ORBIT

Φ45 Adjustable Round 220-240V~ Track Light



view on website



Adjustable Optic

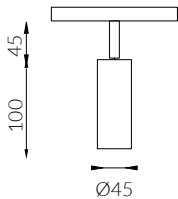

IP Rating:	IP20
Optics:	15°/24°/36°/50°
UGR:	<10
CRI:	98Ra
Lifetime:	>50,000 hrs (L70 B10)
CCT:	2700K/3000K
Typical Source	
Efficacy (lm/W):	110
Control:	On/off, Mains Dim, 0/1-10V, Dali, Zigbee, Casambi
Binning	2 Step MacAdams
Input:	AC220-240V 50/60Hz
Output:	DC 36V 250mA 10W
Ambient temp:	-20 °C to 45 °C
Class:	II
Optional accessories:	Honeycomb louvre, Solite Lense, Spread Lense, Colour Filter

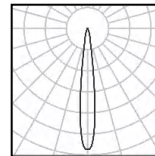

10W Ra98 3000K 15°

h(m)	E(lx)	D(m)
0.5	8822	0.15
1.0	2206	0.30
1.5	980	0.45
2.0	551	0.60
2.5	353	0.76
3.0	245	0.91

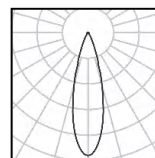

10W Ra98 3000K 24°

h(m)	E(lx)	D(m)
0.5	6615	0.23
1.0	1654	0.46
1.5	735	0.69
2.0	413	0.92
2.5	265	1.15
3.0	184	1.37

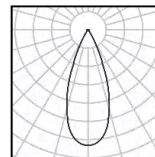

10W Ra98 3000K 36°

h(m)	E(lx)	D(m)
0.5	3458	0.32
1.0	864	0.65
1.5	384	0.97
2.0	216	1.29
2.5	138	1.61
3.0	96	1.94

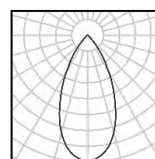

10W Ra98 3000K 50°

h(m)	E(lx)	D(m)
0.5	2048	0.45
1.0	512	0.89
1.5	228	1.34
2.0	128	1.79
2.5	82	2.24
3.0	57	2.68



DuraGreen project:
Agresti Showroom



W system	lm system	optics	code
10W	501	15°	MATL4510W-30N15-B
10W	653	24°	MATL4510W-30N24-B
10W	692	36°	MATL4510W-30N36-B
10W	676	50°	MATL4510W-30N50-B

ORBIT

Φ55 Adjustable Round 220-240V~ Track Light



view on website



Adjustable Optic

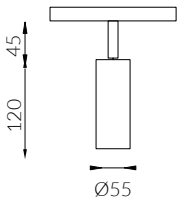

- IP Rating:** IP20
- Optics:** 12°/20°/30°/40°
- UGR:** < 10
- CRI:** 98Ra
- Lifetime:** >50,000 hrs (L70 B10)
- CCT:** 2700K/3000K
- Typical Source**
- Efficacy (lm/W):** 110
- Control:** On/off, Mains Dim, 0/1-10V, Dali, Zigbee, Casambi
- Binning** 2 Step MacAdams
- Input:** AC220-240V 50/60Hz
- Output:** DC 36V 350mA 15W
- Ambient temp:** -20 °C to 45 °C
- Class:** II
- Optional accessories:** Honeycomb louvre, Solite Lense, Spread Lense, Colour Filter

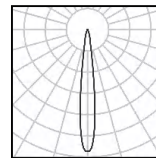

15W Ra98 3000K 12°

h(m)	E(lx)	D(m)
0.5	19862	0.11
1.0	4965	0.22
1.5	2207	0.33
2.0	1241	0.43
2.5	794	0.54
3.0	552	0.65

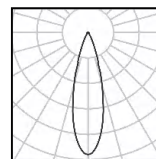

15W Ra98 3000K 20°

h(m)	E(lx)	D(m)
0.5	11574	0.18
1.0	2894	0.36
1.5	1286	0.54
2.0	723	0.72
2.5	463	0.90
3.0	322	1.08

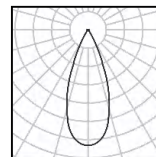

15W Ra98 3000K 30°

h(m)	E(lx)	D(m)
0.5	6165	0.27
1.0	1541	0.54
1.5	685	0.80
2.0	385	1.07
2.5	247	1.34
3.0	171	1.61

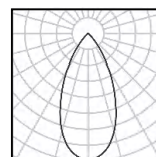

15W Ra98 3000K 40°

h(m)	E(lx)	D(m)
0.5	2648	0.38
1.0	662	0.76
1.5	294	1.15
2.0	166	1.53
2.5	106	1.91
3.0	74	2.29



DuraGreen project:
Minotti Showroom



W system	lm system	optics	code
15W	808	12°	MATL5515W-30N12-B
15W	896	20°	MATL5515W-30N20-B
15W	956	30°	MATL5515W-30N30-B
15W	906	40°	MATL5515W-30N40-B

ORBIT

Φ65 Adjustable Round 220-240V~ Track Light



view on website



Adjustable Optic

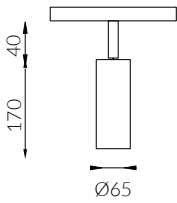

-  matt white painted
-  matt black painted



IP Rating:	IP20
Optics:	15°/20°/36°/55°
UGR:	<10
CRI:	98Ra
Lifetime:	>50,000 hrs (L70 B10)
CCT:	2700K/3000K
Typical Source	
Efficacy (lm/W):	110
Control:	On/off, Mains Dim, 0/1-10V, Dali, Zigbee, Casambi
Binning	2 Step MacAdams
Input:	AC220-240V 50/60Hz
Output:	DC 36V 500mA 20W DC 36V 600mA 25W DC 36V 700mA 30W
Ambient temp:	-20 °C to 45 °C
Class:	II
Optional accessories:	Honeycomb louvre, Solite Lense, Spread Lense, Colour Filter

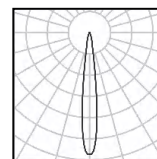

30W Ra98 3000K 15°

h(m)	E lx	D(m)
0.5	36897	0.12
1.0	9224	0.25
1.5	4100	0.37
2.0	2306	0.50
2.5	1476	0.62
3.0	1025	0.75

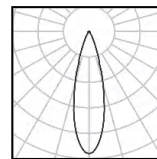

30W Ra98 3000K 24°

h(m)	E lx	D(m)
1.0	29283	0.18
2.0	7321	0.36
3.0	3254	0.53
4.0	1830	0.71
5.0	1171	0.89
6.0	813	1.07

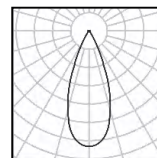

30W Ra98 3000K 36°

h(m)	E lx	D(m)
1.0	11973	0.32
2.0	2993	0.63
3.0	1330	0.95
4.0	748	1.26
5.0	479	1.58
6.0	333	1.89



DuraGreen project:
Yacht Hotel by DC



W system	lm system	optics	code
20W	1348	15°	MATL6520W-30N15-B
20W	1595	24°	MATL6520W-30N24-B
20W	1643	36°	MATL6520W-30N36-B
20W	1369	50°	MATL6520W-30N50-B



W system	lm system	optics	code
25W	1503	15°	MATL6525W-30N15-B
25W	1946	24°	MATL6525W-30N24-B
25W	1909	36°	MATL6525W-30N36-B
25W	1825	50°	MATL6525W-30N50-B



W system	lm system	optics	code
30W	1706	15°	MATL6530W-30N15-B
30W	2219	24°	MATL6530W-30N24-B
30W	2184	36°	MATL6530W-30N36-B
30W	1965	50°	MATL6530W-30N50-B

ORBIT

Φ45 Adjustable 220-240V~ Contour Track Light



view on website



Adjustable Optic

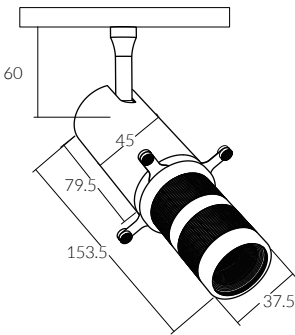

IP Rating:	IP20
Optics:	Framing
UGR:	<10
CRI:	98Ra
Lifetime:	>50,000 hrs (L70 B10)
CCT:	2700K/3000K
Typical Source	
Efficacy (lm/W):	110
Control:	On/off, Mains Dim, 0/1-10V, Dali, Zigbee, Casambi
Binning:	2 Step MacAdams
Input:	AC220-240V 50/60Hz
Output:	DC 36V 250mA 10W
Ambient temp:	-20 °C to 45 °C
Class:	II

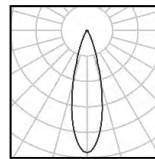

10W Ra98 3000K 24°

h(m)	E(k)	D(m)
0.5	3216	0.21
1.0	804	0.42
1.5	357	0.63
2.0	201	0.84
2.5	129	1.04
3.0	89	1.25



W system	lm system	code
10W	239	MATLC4510W

LED STRIP

EVO-STRIP / LINE / NEONFLEX / RIGID PROFILE

EVO-STRIP



Evo-Strip is a premium range of flexible strips crafted for the most stylish residential and commercial interiors that demand exceptional colour rendering and consistency. Evo-Strip lights achieve an impressive CRI 98, aligning flawlessly with our full spectrum downlights and spotlights. Our RGBCW solution offers a dynamic combination of RGB and tunable white (2700K to 6000K) in a single product, effectively resolving the issue of brightness often experienced with white lights on RGBCW strips. With an innovative wall wash lens within a sleek micro aluminium profile, our linear lens lends itself perfectly to wall washing, curtain or shutter lighting, and even kitchen worktop lighting.



EVO-STRIP

LINEAR WALLWASH



Wall Wash Optic



view on website

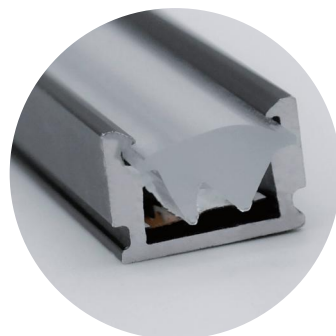
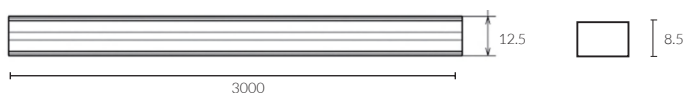

IP Rating:	IP20
Optics:	Wall Wash
UGR:	<17
CRI:	92Ra
Lifetime:	>50,000 hrs (L70 B10)
CCT:	3000K
Typical Source Efficacy (lm/W):	113
Control:	On/off, Mains Dim, 0/1-10V, Dali, Zigbee, Casambi
Binning:	3 Step MacAdams
Voltage:	DC 24V
Power(W):	15W/m
LEDs/m:	240
Min. Cut Length:	50mm
Ambient temp:	-20 °C to 45 °C
Class:	III

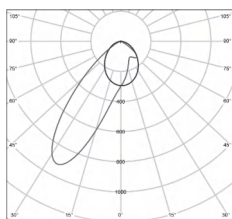

Accessories not included

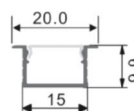

GLL-1

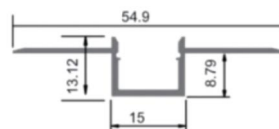

GLL-2

installation profile recommended



DuraGreen project:
Luxury Home Taizhou



W system	Im system	optics	code
15W	870	Wall Wash	GLL-W-15W-24V

EVO-STRIP

LED STRIP FULL SPECTRUM



[view on website](#)



Fixed Optic

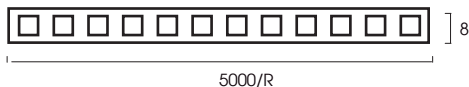

Accessories not included



Fast Connector (FC1010)

IP Rating:	IP20
Optics:	120°
CRI:	98Ra
Lifetime:	>50,000 hrs (L70 B10)
CCT:	3000K/3500K
Typical Source Efficacy (lm/W):	99
Control:	On/off, Mains Dim, 0/1-10V, Dali, Zigbee, Casambi
Binning:	3 Step MacAdams
Voltage:	DC 24V
Power(W):	12W/m
LEDs/m:	128
Min. Cut Length:	50mm
Ambient temp:	-20 °C to 45 °C
Class:	III



DuraGreen project:
Veneta Cucine



W system	CCT	lm system	optics	code
12W	3000K	99lm/W	120°	GS2835-128-12W-30-98

EVO-STRIP

LED STRIP RGB+W+CW



Fixed Optic

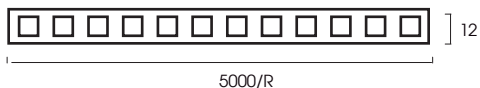

[view on website](#)



IP Rating:	IP20
Optics:	120°
CRI:	92Ra
Lifetime:	>50,000 hrs (L70 B10)
CCT:	2700K-6000K + RGB
Typical Source	
Efficacy (lm/W):	6000K 94 lm/W, 2700K 84 lm/W, R 21 lm/W, G 55 lm/W, B 15 lm/W
Control:	DMX, DALI, Zigbee, Casambi
Binning:	3 Step MacAdams
Voltage:	DC 24V
Power(W):	RGB=12W/M W-7W CW-7W
LEDs/m:	180
Min. Cut Length:	100mm
Ambient temp:	-20 °C to 45 °C
Class:	III



DuraGreen project:
Gravity Office UK



W system	lm system	optics	code
R=4W	20lm/W	120°	GS2840-180-12W-RGBWCW
G=4W	54lm/W		
B=4W	15lm/W		
W=7W	83lm/W		
CW=7W	94lm/W		

LINE

LED STRIP GENERAL



Fixed Optic

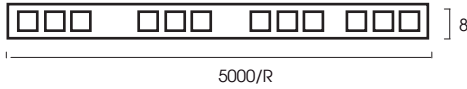

[view on website](#)



Accessories not included



Fast Connector (FC1010)

IP Rating:	IP20
Optics:	120°
CRI:	92Ra
Lifetime:	>50,000 hrs (L70 B10)
CCT:	2700K/3000K/3500K/4000K/5000K
Control:	On/off, Mains Dim, 0/1-10V, Dali, Zigbee, Casambi
Binning:	2 Step MacAdams
Voltage:	DC 24V
Power(W):	3.6W/m, 6W/m, 7.2W/m, 9.6W/m, 12W/m, 15W/m
LEDs/m:	120
Min. Cut Length:	50mm
Ambient temp:	-20 °C to 45 °C
Class:	III



W system	lm system	optics	code
3.6W	103lm/W	120°	GS2835-120-3.6W-24



W system	lm system	optics	code
6W	103lm/W	120°	GS2835-120-6W-24



W system	lm system	optics	code
7.2W	90lm/W	120°	GS2835-120-7.2W-24



W system	lm system	optics	code
9.6W	90lm/W	120°	GS2835-120-9.6W-24



W system	lm system	optics	code
12W	90lm/W	120°	GS2835-120-12W-24



W system	lm system	optics	code
15W	90lm/W	120°	GS2835-120-15W-24

LINE

LED STRIP ADVANCED



Fixed Optic

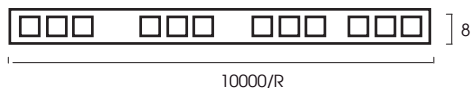

[view on website](#)

premium high efficiency 170 Lumen / Watt, 10 meter per roll



Accessories not included

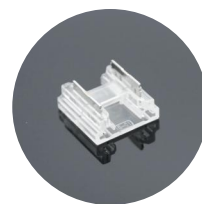

Fast Connector (FC1010)

IP Rating:	IP20
Optics:	120°
CRI:	92Ra
Lifetime:	>50,000 hrs (L70 B10)
CCT:	2700K/3000K/3500K/4000K/5000K
Typical Source Efficacy (lm/W):	170
Control:	On/off, Mains Dim, 0/1-10V, Dali, Zigbee, Casambi
Binning:	2 Step MacAdams
Voltage:	DC 24V
Power(W):	6W/m
LEDs/m:	168
Min. Cut Length:	50mm
Ambient temp:	-20 °C to 45 °C
Class:	III



W system	lm system	optics	code
6W	170Lm/W	120°	GS2835-128-6W-24

LINE

LED STRIP TUNABLE WHITE



[view on website](#)



Fixed Optic

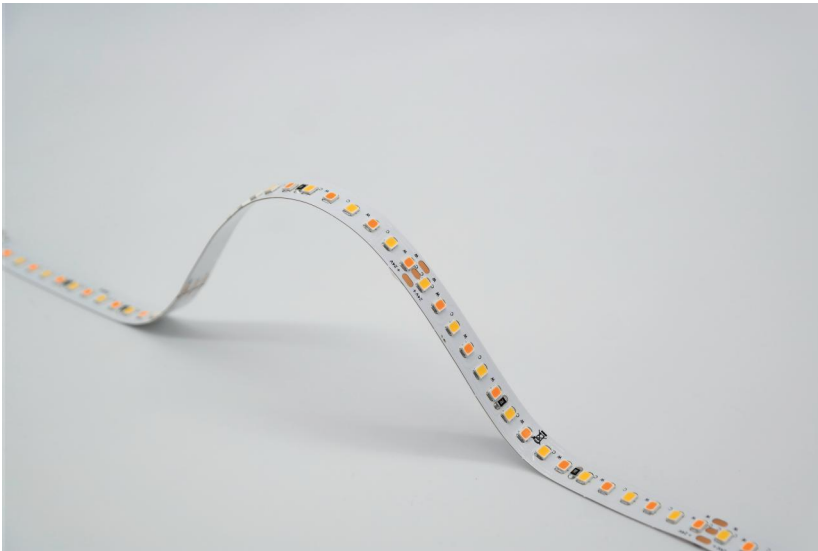
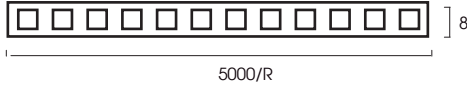

IP Rating:	IP20
Optics:	120°
CRI:	92Ra
Lifetime:	>50,000 hrs (L70 B10)
CCT:	2700K-6500K/1800K-4000K
Typical Source Efficacy (lm/W):	174
Control:	On/off, Mains Dim, 0/1-10V, Dali, Zigbee, Casambi
Binning:	2 Step MacAdams
Voltage:	DC 24V
Power(W):	10W/m
LEDs/m:	160
Min. Cut Length:	50mm
Ambient temp:	-20 °C to 45 °C
Class:	III



W system	CCT	lm system	optics	code
10W	2700K-6500K	174lm/W	120°	GS2835-160-10W-2765



W system	CCT	lm system	optics	code
10W	1800K-4000K	174lm/W	120°	GS2835-160-10W-1840

LINE

LED STRIP COB



Fixed Optic

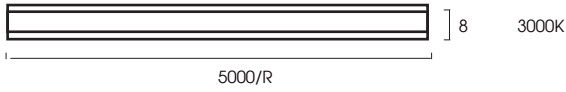

[view on website](#)



IP Rating:	IP20
Optics:	120°
CRI:	92Ra
Lifetime:	>50,000 hrs (L70 B10)
CCT:	3000K/RGBW
Typical Source Efficacy (lm/W):	85
Control:	On/off, Mains Dim, 0/1-10V, Dali, Zigbee, Casambi
Binning:	2 Step MacAdams
Voltage:	DC 24V
Power(W):	9W/m(3000K) / 18W/m(RGBW)
LEDs/m:	480
Min. Cut Length:	50mm
Ambient temp:	-20 °C to 45 °C
Class:	III



DuraGreen project:
LARVOTTO Club House

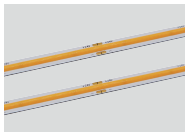

W system	CCT	lm system	optics	code
9W	3000K	85lm/W	180°	GSCOB-480-9W-30



W system	lm system	optics	code
R=4W	25lm/W	180°	GSCOB-480-18W-RGBW
G=3W	105lm/W		
B=5W	17lm/W		
W=5W	80lm/W		

LINE

LED STRIP SILICONE



Fixed Optic

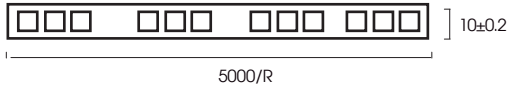

[view on website](#)



IP Rating:	IP65
Optics:	120°
CRI:	92Ra
Lifetime:	>50,000 hrs (L70 B10)
CCT:	2700K/3000K/3500K/4000K/5000K/2700K-6500K/1800K-4000K
Typical Source Efficacy (lm/W):	113
Control:	On/off, Mains Dim, 0/1-10V, Dali, Zigbee, Casambi
Binning:	2 Step MacAdams
Voltage:	DC 24V
Power(W):	3.6W/m, 6W/m, 7.2W/m, 9.6W/m, 12W/m, 15W/m
LEDs/m:	120
Min. Cut Length:	50mm
Ambient temp:	-20 °C to 45 °C
Class:	III



W system	lm system	optics	code
3.6W	91lm/W	120°	GS2835-120-3.6W-24-WP



W system	lm system	optics	code
6W	91lm/W	120°	GS2835-120-6W-24-WP



W system	lm system	optics	code
7.2W	81lm/W	120°	GS2835-120-7.2W-24-WP



W system	lm system	optics	code
9.6W	81lm/W	120°	GS2835-120-9.6W-24-WP



W system	lm system	optics	code
12W	81lm/W	120°	GS2835-120-12W-24-WP



W system	lm system	optics	code
15W	81lm/W	120°	GS2835-120-15W-24-WP

NEONFLEX

NEON STRIP 1010 BEND TOP

flexible on the horizontal axis



[view on website](#)

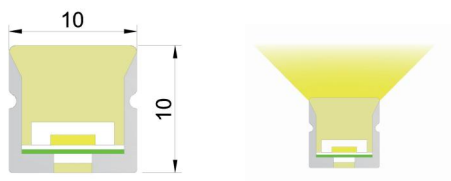

BEND TOP

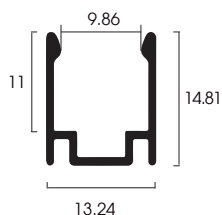

AP1010U



Accessories not included



Clips (AC1010U)

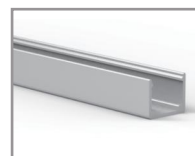

Rigid Profile (AP1010U)



Flexible Profile (AF1010U)

IP Rating:	IP67
Optics:	115°
CRI:	92Ra
Lifetime:	>50,000 hrs (L70 B10)
CCT:	2700K/3000K/4000K/6500K
Typical Source Efficacy (lm/W):	113
Control:	On/off, Mains Dim, 0/1-10V, Dali, Zigbee, Casambi
Binning:	2 Step MacAdams
Voltage:	DC 24V
Power(W):	10W/m
Ambient temp:	-20 °C to 45 °C
Class:	III



W system	lm system	optics	code
10W	70Lm /W	115°	E67-BT1010-10W-27
10W	70Lm /W	115°	E67-BT1010-10W-30
10W	72Lm /W	115°	E67-BT1010-10W-40
10W	72Lm /W	115°	E67-BT1010-10W-65

NEONFLEX

NEON STRIP 1010 BEND SIDE

flexible on the vertical axis



[view on website](#)

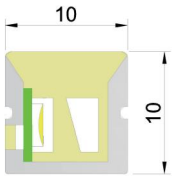

BEND SIDE

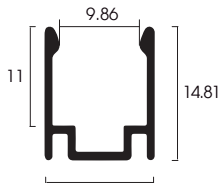
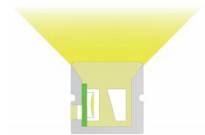

AP1010U



Accessories not included

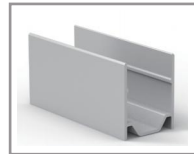

Clips (AC1010U)

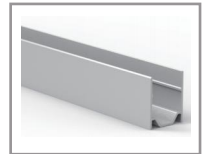

Rigid Profile (AP1010U)



Flexible Profile (AF1010U)

IP Rating:	IP67
Optics:	115°
CRI:	92Ra
Lifetime:	>50,000 hrs (L70 B10)
CCT:	2700K/3000K/4000K/6500K
Typical Source Efficacy (lm/W):	113
Control:	On/off, Mains Dim, 0/1-10V, Dali, Zigbee, Casambi
Binning:	2 Step MacAdams
Voltage:	DC 24V
Power(W):	7W/m , 10W/m
Ambient temp:	-20 °C to 45 °C
Class:	III



W system	lm system	optics	code
7W	50Lm /W	115°	E67-BS1010-07W-27
7W	50Lm /W	115°	E67-BS1010-07W-30
7W	52Lm /W	115°	E67-BS1010-07W-40
7W	52Lm /W	115°	E67-BS1010-07W-65



W system	lm system	optics	code
10W	50Lm /W	115°	E67-BS1010-10W-27
10W	50Lm /W	115°	E67-BS1010-10W-30
10W	52Lm /W	115°	E67-BS1010-10W-40
10W	52Lm /W	115°	E67-BS1010-10W-65

NEONFLEX

NEON STRIP 1616 BEND TOP

flexible on the horizontal axis



view on website

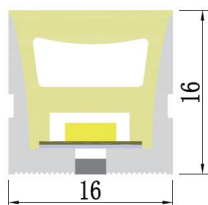

BEND TOP

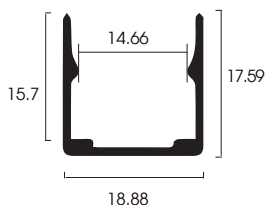

AP1616U



Accessories not included



Clips (AC1616U)



Rigid Profile (AP1616U)

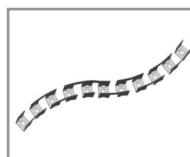

Flexible Profile (AF1616U)

IP Rating:	IP67
Optics:	115°
CRI:	92Ra
Lifetime:	>50,000 hrs (L70 B10)
CCT:	2700K/3000K/4000K/6500K/2700K-6500K/RGBW
Typical Source	
Efficacy (lm/W):	113
Control:	On/off, Mains Dim, 0/1-10V, Dali, Zigbee, Casambi
Binning:	2 Step MacAdams
Voltage:	DC 24V
Power(W):	8W/m, 10W/m, 15W/m, 20W/m
Ambient temp:	-20 °C to 45 °C
Class:	III



DuraGreen project:
London Luxury Home



W system	lm system	optics	code
8W	70Lm /W	115°	E67-BT1616-08W-27
8W	70Lm /W	115°	E67-BT1616-08W-30
8W	72Lm /W	115°	E67-BT1616-08W-40
8W	72Lm /W	115°	E67-BT1616-08W-65
8W	78Lm /W	115°	E67-BT1616-08W-2765
8W	20Lm /W	115°	E67-BT1616-08W-RGBW



W system	lm system	optics	code
10W	70Lm /W	115°	E67-BT1616-10W-27
10W	70Lm /W	115°	E67-BT1616-10W-30
10W	72Lm /W	115°	E67-BT1616-10W-40
10W	72Lm /W	115°	E67-BT1616-10W-65
10W	78Lm /W	115°	E67-BT1616-10W-2765
10W	20Lm /W	115°	E67-BT1616-10W-RGBW



W system	lm system	optics	code
15W	70Lm /W	115°	E67-BT1616-15W-27
15W	70Lm /W	115°	E67-BT1616-15W-30
15W	72Lm /W	115°	E67-BT1616-15W-40
15W	72Lm /W	115°	E67-BT1616-15W-65
15W	78Lm /W	115°	E67-BT1616-15W-2765
15W	20Lm /W	115°	E67-BT1616-15W-RGBW

NEONFLEX

NEON STRIP 1616 BEND TOP IP68

flexible on the horizontal axis



[view on website](#)

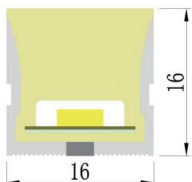

BEND TOP

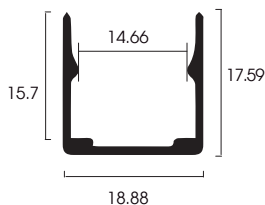

AP1616U



Accessories not included



Clips (AC1616U)



Rigid Profile (AP1616U)

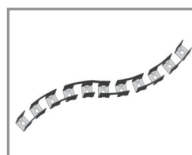

Flexible Profile (AF1616U)

IP Rating:	IP68
Optics:	115°
CRI:	92Ra
Lifetime:	>50,000 hrs (L70 B10)
CCT:	2700K/3000K/4000K/6500K/2700K-6500K
Typical Source Efficacy (lm/W):	113
Control:	On/off, Mains Dim, 0/1-10V, Dali, Zigbee, Casambi
Binning:	2 Step MacAdams
Voltage:	DC 24V
Power(W):	12W/m
Ambient temp:	-20 °C to 45 °C
Class:	III



W system	lm system	optics	code
12W	70Lm/W	115°	E68-BT1616-12W-27
12W	70Lm/W	115°	E68-BT1616-12W-30
12W	72Lm/W	115°	E68-BT1616-12W-40
12W	72Lm/W	115°	E68-BT1616-12W-65
12W	78Lm/W	115°	E68-BT1616-12W-2765



W system	lm system	optics	code
R=4W	10Lm/W	115°	E68-BT1616-12W-RGBW
G=4W	26Lm/W		
B=4W	5Lm/W		
W=4W	35Lm/W		

NEONFLEX

NEON STRIP 1616 BEND SIDE

flexible on the vertical axis



[view on website](#)

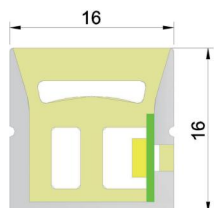

BEND SIDE

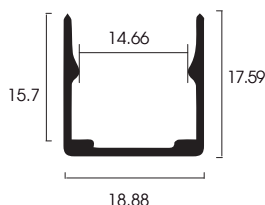
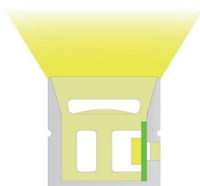

AP1616U



Accessories not included

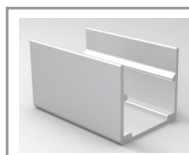

Clips (AC1616U)



Rigid Profile (AP1616U)

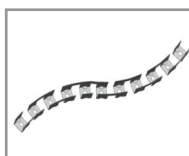

Flexible Profile (AF1616U)

IP Rating:	IP67
Optics:	115°
CRI:	92Ra
Lifetime:	>50,000 hrs (L70 B10)
CCT:	2700K/3000K/4000K/6500K/2700K-6500K/RGBW
Typical Source Efficacy (lm/W):	113
Control:	On/off, Mains Dim, 0/1-10V, Dali, Zigbee, Casambi
Binning:	2 Step MacAdams
Voltage:	DC 24V
Power(W):	8W/m, 10W/m, 15W/m
Ambient temp:	-20 °C to 45 °C
Class:	III



W system	lm system	optics	code
8W	50Lm /W	115°	E67-BS1616-08W-27
8W	50Lm /W	115°	E67-BS1616-08W-30
8W	52Lm /W	115°	E67-BS1616-08W-40
8W	52Lm /W	115°	E67-BS1616-08W-65
8W	52Lm /W	115°	E67-BS1616-08W-2765
8W	20Lm /W	115°	E67-BS1616-08W-RGBW



W system	lm system	optics	code
10W	50Lm /W	115°	E67-BS1616-10W-27
10W	50Lm /W	115°	E67-BS1616-10W-30
10W	52Lm /W	115°	E67-BS1616-10W-40
10W	52Lm /W	115°	E67-BS1616-10W-65
10W	52Lm /W	115°	E67-BS1616-10W-2765
10W	20Lm /W	115°	E67-BS1616-10W-RGBW



W system	lm system	optics	code
15W	50Lm /W	115°	E67-BS1616-15W-27
15W	50Lm /W	115°	E67-BS1616-15W-30
15W	52Lm /W	115°	E67-BS1616-15W-40
15W	52Lm /W	115°	E67-BS1616-15W-65
15W	52Lm /W	115°	E67-BS1616-15W-2765
15W	20Lm /W	115°	E67-BS1616-15W-RGBW

NEONFLEX

NEON STRIP 0612 BEND SIDE

flexible on the vertical axis



[view on website](#)

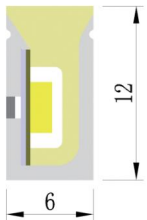

BEND SIDE

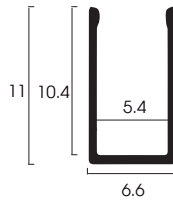
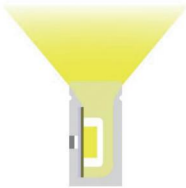

AP0612U



Accessories not included

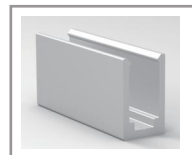

Clips (AC0612U)

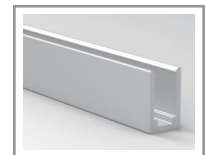

Rigid Profile (AP0612U)

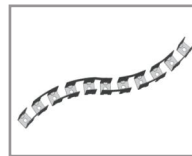

Flexible Profile (AF0612U)

IP Rating:	IP67
Optics:	115°
CRI:	92Ra
Lifetime:	>50,000 hrs (L70 B10)
CCT:	2700K/3000K/4000K/6500K/2700K-6500K
Typical Source	
Efficacy (lm/W):	113
Control:	On/off, Mains Dim, 0/1-10V, Dali, Zigbee, Casambi
Binning:	2 Step MacAdams
Voltage:	DC 24V
Power(W):	7W/m, 10W/m
Ambient temp:	-20 °C to 45 °C
Class:	III



W system	lm system	optics	code
7W	50Lm /W	115°	E67-BS0612-07W-27
7W	50Lm /W	115°	E67-BS0612-07W-30
7W	52Lm /W	115°	E67-BS0612-07W-40
7W	52Lm /W	115°	E67-BS0612-07W-65



W system	lm system	optics	code
10W	50Lm /W	115°	E67-BS0612-10W-27
10W	50Lm /W	115°	E67-BS0612-10W-30
10W	52Lm /W	115°	E67-BS0612-10W-40
10W	52Lm /W	115°	E67-BS0612-10W-65

RIGID PROFILE



ALP001-R

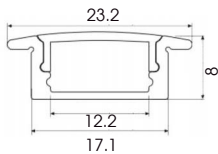

ALP002-R

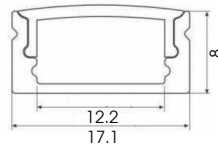

ALP002-RL

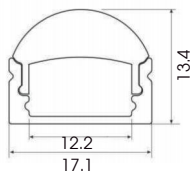

ALP003-R

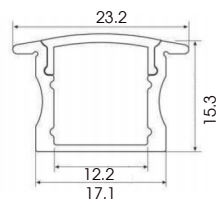

ALP004-RL

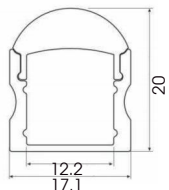

ALP004-R

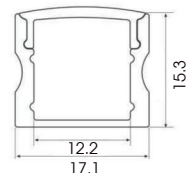

ALP005

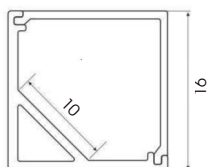

ALP006

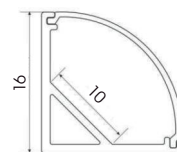

ALP007-R

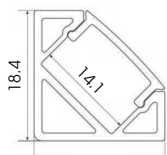

ALP010

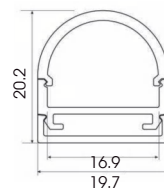

ALP011

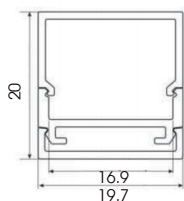

ALP018-R3

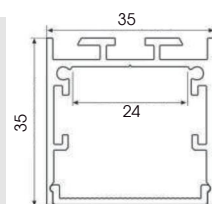

RIGID PROFILE

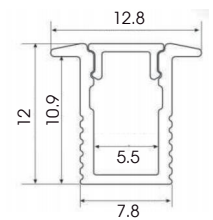
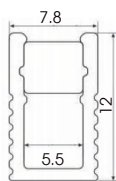
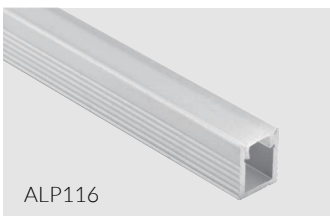
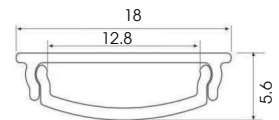
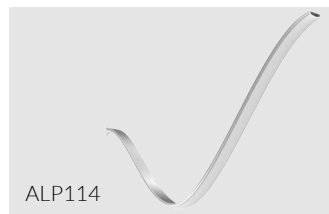
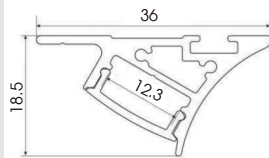
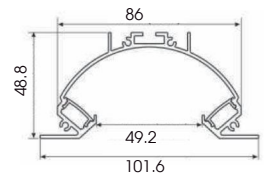
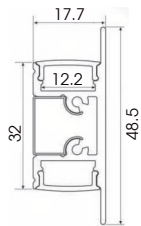
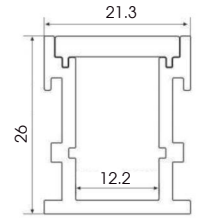
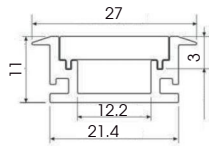
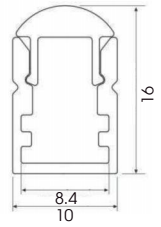
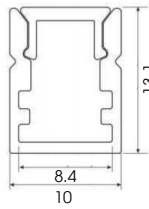
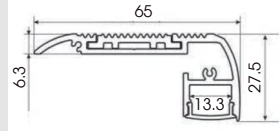
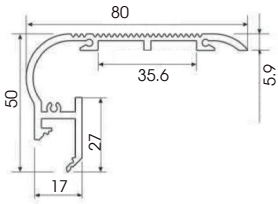

RIGID PROFILE

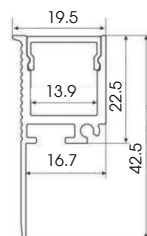
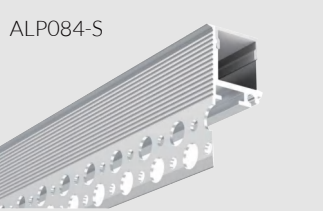
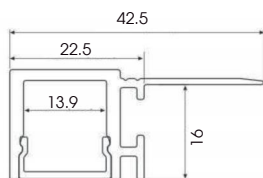
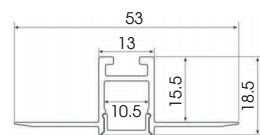
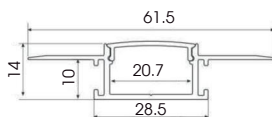
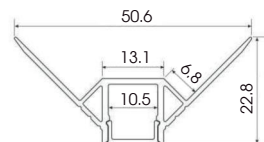
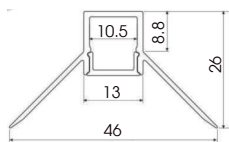
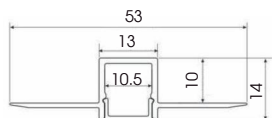
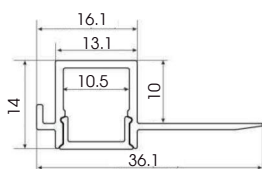
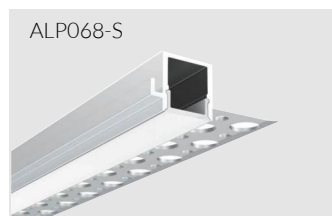
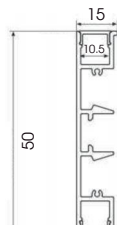
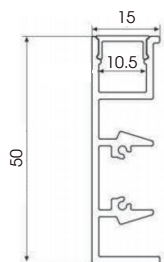

RIGID PROFILE



ALP087

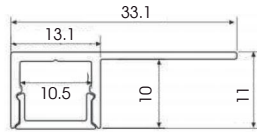

ALP088

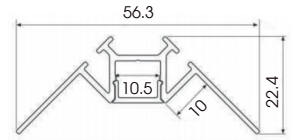

ALP089

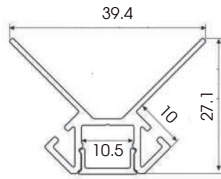

ALP093

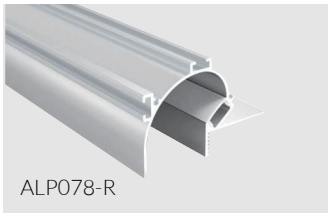
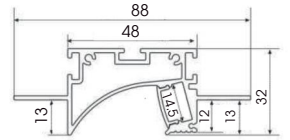

ALP078-R

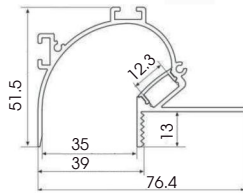

ALP126

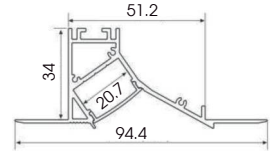

ALP127

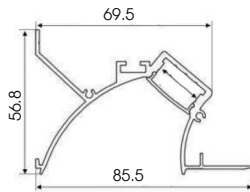

ALP128

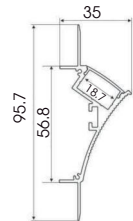

ALP5213

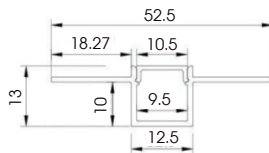

OUTDOOR

FOCUS / MOOD / DOME / STICK / ACME / WASHFLEX

OUTDOOR



Experience the finest selection of architectural outdoor lighting that effortlessly accentuates both outdoor landscapes and architecture, creating stunning and functional outdoor spaces. Our fast plug-and-play connection system revolutionizes the process of designing and planning the ideal outdoor lighting, making it easier than ever before.



FOCUS

Φ32 Outdoor Uplights



view on website



cutout :32mm



Fixed Optic



glare shield 50%

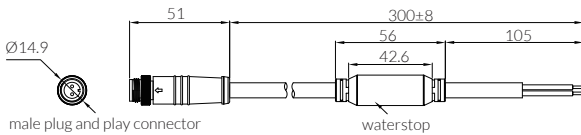
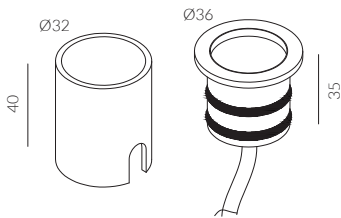

- IP Rating:** IP67
- Optics:** 10°/20°/30°
- UGR:** <19
- CRI:** 92Ra
- Lifetime:** >50,000 hrs (L70 B10)
- CCT:** 3000K
- Typical Source**
- Efficacy (lm/W):** 113
- Control:** On/off, Mains Dim, 0/1-10V, Dali, Zigbee, Casambi
- Binning** 2 Step MacAdams
- Voltage:** DC 24V
- Power(W):** 2.5W
- Ambient temp:** -20 °C to 45 °C
- Class:** III
- Plug Type:** Plug & Play (2 pin) - male

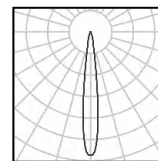

2.5W Ra92 3000K 10°

h(m)	E(lx)	D(m)
0.5	4115	0.09
1.0	1029	0.28
1.5	457	0.27
2.0	257	0.36
2.5	165	0.46
3.0	114	0.55

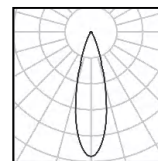

2.5W Ra92 3000K 20°

h(m)	E(lx)	D(m)
0.5	1155	0.20
1.0	289	0.41
1.5	128	0.61
2.0	72	0.81
2.5	46	1.02
3.0	32	1.22

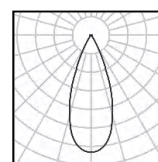

2.5W Ra92 3000K 30°

h(m)	E(lx)	D(m)
0.5	776	0.29
1.0	194	0.58
1.5	86	0.88
2.0	48	1.17
2.5	31	1.46
3.0	22	1.75



DuraGreen project:
Luxury Home London



W system	lm system	optics	code
2.5W	123	10°	UL322.5W-10
2.5W	94	20°	UL322.5W-20
2.5W	124	30°	UL322.5W-30

FOCUS

Φ70 Outdoor Uplights



view on website



cutout :70mm



Fixed Optic

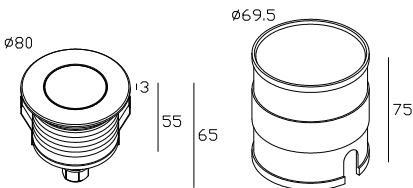

honeycomb as default

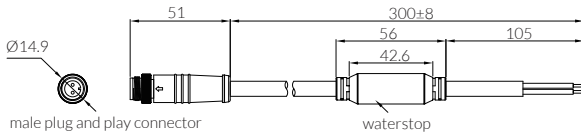

- IP Rating:** IP67
- Optics:** 15°/24°/36°
- UGR:** <19
- CRI:** 92Ra
- Lifetime:** >50,000 hrs (L70 B10)
- CCT:** 3000K
- Typical Source Efficacy (lm/W):** 113
- Control:** On/off, Mains Dim, 0/1-10V, Dali, Zigbee, Casambi
- Binning:** 2 Step MacAdams
- Voltage:** DC 24V
- Power(W):** 8W
- Ambient temp:** -20 °C to 45 °C
- Class:** III
- Plug Type:** Plug & Play (2 pin) - male

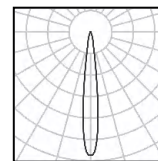

8W Ra92 3000K 15°

h(m)	E(lx)	D(m)
0.5	8789	0.17
1.0	2197	0.35
1.5	977	0.52
2.0	549	0.70
2.5	352	0.87
3.0	244	1.05

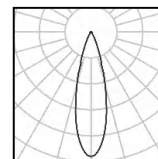

8W Ra92 3000K 24°

h(m)	E(lx)	D(m)
0.5	5435	0.27
1.0	1359	0.53
1.5	604	0.80
2.0	340	1.06
2.5	217	1.33
3.0	151	1.60

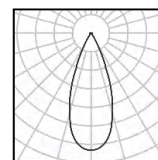

8W Ra92 3000K 36°

h(m)	E(lx)	D(m)
0.5	2746	0.38
1.0	686	0.76
1.5	305	1.14
2.0	172	1.52
2.5	110	1.90
3.0	76	2.28



DuraGreen project:
Curio Hotel by Hilton, La Festa

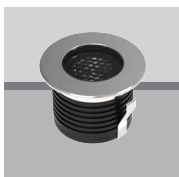

W system	lm system	optics	code
8W	549	15°	UL7008W-30N15-W
8W	627	24°	UL7008W-30N24-W
8W	603	36°	UL7008W-30N36-W

FOCUS

Φ104 Outdoor Uplights



view on website



cutout : 104mm



Fixed Optic

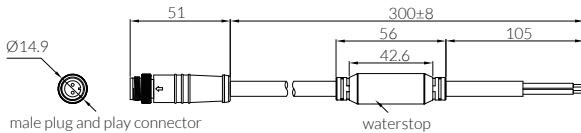
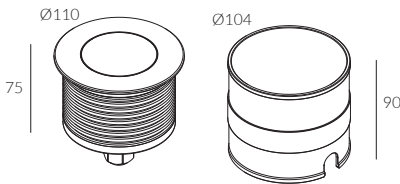

- IP Rating:** IP67
- Optics:** 15°/24°/36°
- UGR:** <19
- CRI:** 92Ra
- Lifetime:** >50,000 hrs (L70 B10)
- CCT:** 3000K
- Typical Source**
- Efficacy (lm/W):** 113
- Control:** On/off, Mains Dim, 0/1-10V, Dali, Zigbee, Casambi
- Binning** 2 Step MacAdams
- Voltage:** DC 24V
- Power(W):** 12W
- Ambient temp:** -20 °C to 45 °C
- Class:** III
- Plug Type:** Plug & Play (2 pin) - male

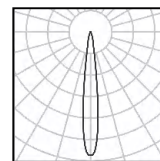

12W Ra92 3000K 15°

h(m)	E(lx)	D(m)
0.5	20029	0.11
1.0	5007	0.22
1.5	2225	0.33
2.0	1252	0.44
2.5	801	0.55
3.0	556	0.66

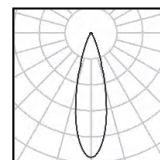

12W Ra92 3000K 24°

h(m)	E(lx)	D(m)
0.5	10775	0.20
1.0	2694	0.39
1.5	1197	0.59
2.0	673	0.78
2.5	431	0.98
3.0	299	1.18

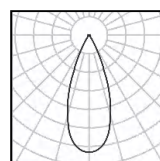

20W Ra92 3000K 36°

h(m)	E(lx)	D(m)
1.0	5118	0.28
2.0	1280	0.57
3.0	569	0.85
4.0	320	1.14
5.0	205	1.42
6.0	142	1.71

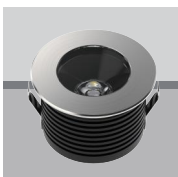
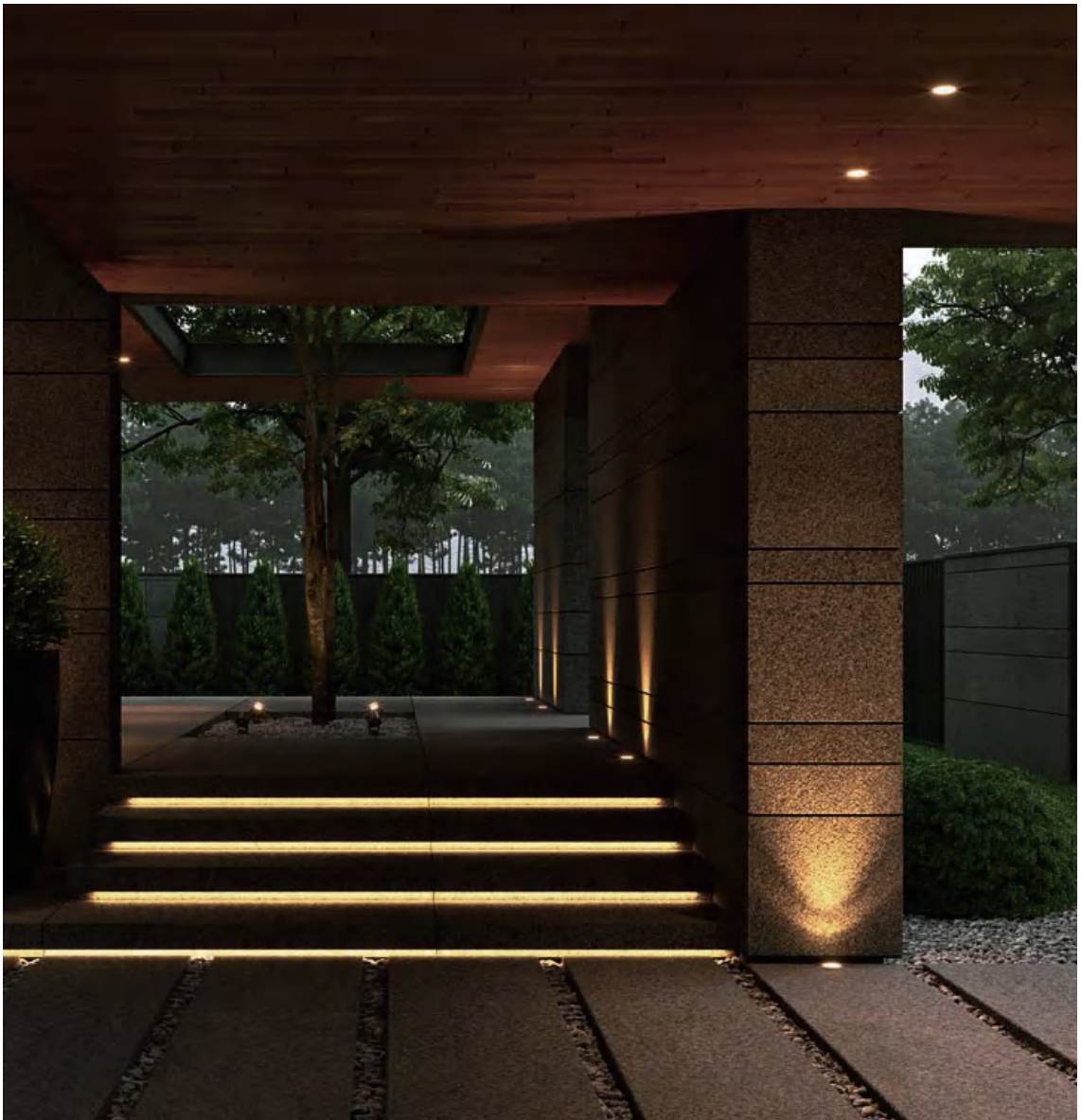

W system	lm system	optics	code
12W	639	15°	UL10412W-30N15
12W	936	24°	UL10412W-30N24
12W	933	36°	UL10412W-30N36

FOCUS

Φ140 Outdoor Uplights



view on website



cutout : 140mm



Fixed Optic

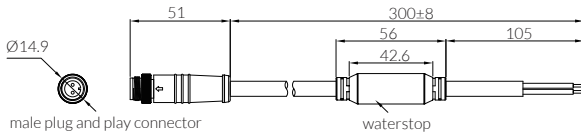
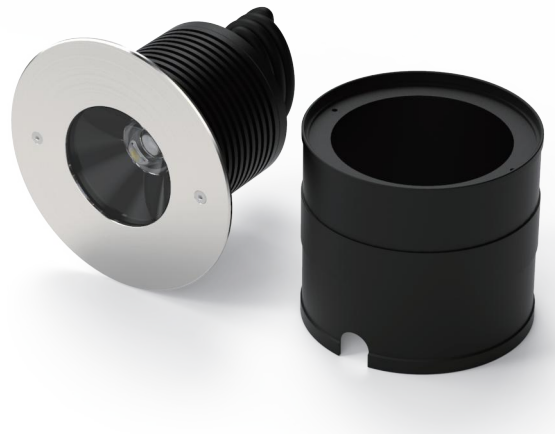
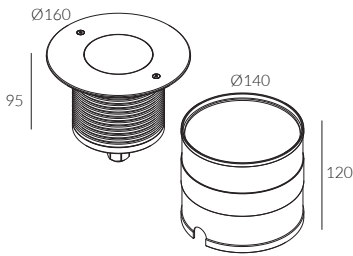

- IP Rating:** IP67
- Optics:** 15°/24°/36°
- UGR:** <19
- CRI:** 92Ra
- Lifetime:** >50,000 hrs (L70 B10)
- CCT:** 3000K
- Typical Source**
- Efficacy (lm/W):** 113
- Control:** On/off, Mains Dim, 0/1-10V, Dali, Zigbee, Casambi
- Binning** 2 Step MacAdams
- Voltage:** DC 24V
- Power(W):** 20W
- Ambient temp:** -20 °C to 45 °C
- Class:** III
- Plug Type:** Plug & Play (2 pin) - male

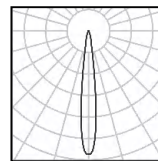

20W Ra92 3000K 15°

h(m)	E(lx)	D(m)
1.0	26454	0.12
2.0	6613	0.25
3.0	2939	0.37
4.0	1653	0.49
5.0	1058	0.61
6.0	735	0.74

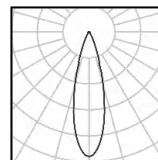

20W Ra92 3000K 24°

h(m)	E(lx)	D(m)
1.0	11917	0.24
2.0	2979	0.48
3.0	1324	0.72
4.0	745	0.96
5.0	477	1.20
6.0	331	1.44

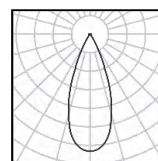

20W Ra92 3000K 36°

h(m)	E(lx)	D(m)
1.0	6521	0.35
2.0	1630	0.70
3.0	725	1.05
4.0	408	1.40
5.0	261	1.75
6.0	181	2.10



W system	lm system	optics	code
20W	1043	15°	UL14020W-30N15
20W	1503	24°	UL14020W-30N24
20W	1458	36°	UL14020W-30N36

FOCUS

Φ78

Outdoor Asymmetric Surface Washer



[view on website](#)



Asymmetric optics

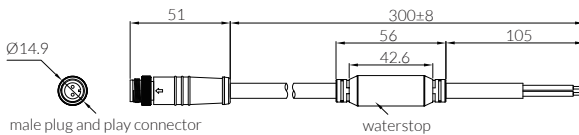
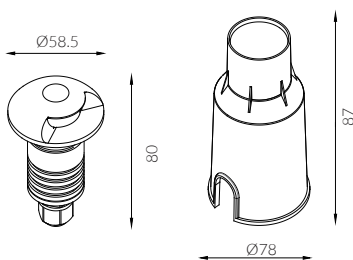

male plug and play connector

waterstop

IP Rating:	IP67
Optics:	Asymmetric
UGR:	<19
CRI:	92Ra
Lifetime:	>50,000 hrs (L70 B10)
CCT:	3000K
Typical Source	
Efficacy (lm/W):	113
Control:	On/off
Binning	2 Step MacAdams
Voltage:	DC 24V
Power(W):	3W
Ambient temp:	-20 °C to 45 °C
Class:	III
Plug Type:	Plug & Play (2 pin) - male

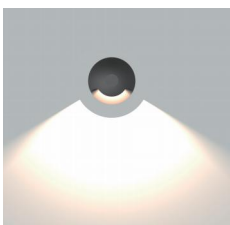

W system	lm system	optics	code
3W	104	Asymmetric	SD1607A

FOCUS

Outdoor Projector

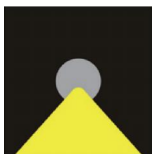

Adjustable Optic

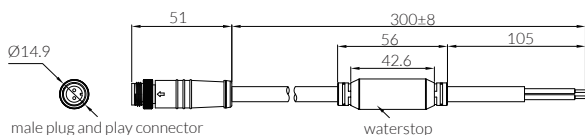
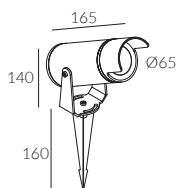
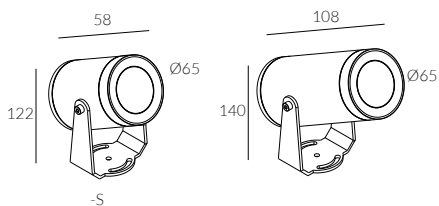

- IP Rating:** IP66
- Optics:** 15°/24°/36°/50°
- UGR:** <19
- CRI:** 92Ra
- Lifetime:** >50,000 hrs (L70 B10)
- CCT:** 3000K
- Typical Source**
- Efficacy (lm/W):** 113
- Control:** On/off
- Binning** 2 Step MacAdams
- Voltage:** DC 24V
- Power(W):** 7W/10W/15W
- Ambient temp:** -20 C to 45 C
- Class:** III
- Plug Type:** Plug & Play (2 pin) - male



view on website

Accessories not included

Ground Stake



Code: ODG-1
Dimensions: Ø38mm*H160mm

Tree / pole bracket



Code: ODG-2
Dimensions: 1M/1.5M/2M

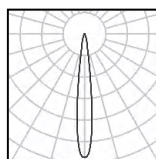

15W Ra92 3000K 15°

h(m)	E(lx)	D(m)
0.5	19856	0.12
1.0	4964	0.23
1.5	2206	0.35
2.0	1241	0.46
2.5	794	0.58
3.0	552	0.69

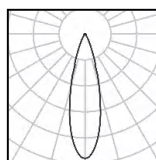

15W Ra92 3000K 24°

h(m)	E(lx)	D(m)
0.5	9636	0.20
1.0	2409	0.41
1.5	1071	0.61
2.0	602	0.81
2.5	385	1.02
3.0	268	1.22

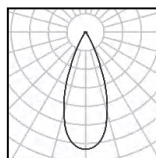

15W Ra92 3000K 36°

h(m)	E(lx)	D(m)
0.5	5780	0.30
1.0	1445	0.60
1.5	642	0.89
2.0	361	1.19
2.5	231	1.49
3.0	161	1.79

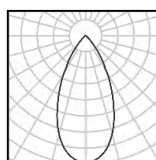

15W Ra92 3000K 50°

h(m)	E(lx)	D(m)
0.5	2268	0.46
1.0	567	0.92
1.5	252	1.37
2.0	142	1.83
2.5	91	2.29
3.0	63	2.75



DuraGreen project:
Home Garden, London



W system	lm system	optics	code
7W	549	15°	SF6507W-S-15
7W	627	24°	SF6507W-S-24
7W	603	36°	SF6507W-S-36
7W	592	50°	SF6507W-S-50



W system	lm system	optics	code
10W	749	15°	SF6510W-15
10W	849	24°	SF6510W-24
10W	834	36°	SF6510W-36
10W	811	50°	SF6510W-50



W system	lm system	optics	code
15W	984	15°	SF6515W-15
15W	1124	24°	SF6515W-24
15W	1086	36°	SF6515W-36
15W	1055	50°	SF6515W-50

Φ38 Outdoor Projector Zoomable 20°-50°



Adjustable Optic

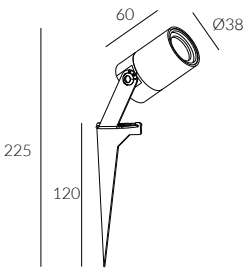

Structure Finish

- Green Painted
- Solid Brass

- IP Rating:** IP66
- Optics:** Zoomable 20°-50°
- UGR:** < 17
- CRI:** 92Ra
- Lifetime:** >50,000 hrs (L70 B10)
- CCT:** 3000K/3500K
- Typical Source**
- Efficacy (lm/W):** 96
- Control:** On/off, Mains Dim, 0/1-10V, Dali
- Binning** 2 Step MacAdams
- Input:** AC220-240V 50/60Hz
- Output:** DC 12V 600mA 8W
- Ambient temp:** -20 °C to 45 °C
- Class:** II
- Material:** Fine aluminium 6063A

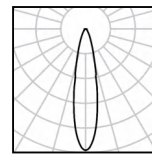

8W Ra92 3000K 20°

h(m)	E(lx)	D(m)
0.5	2978	0.21
1.0	745	0.42
1.5	331	0.63
2.0	186	0.84
2.5	119	1.04
3.0	83	1.25

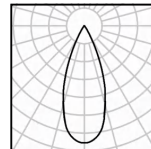

8W Ra92 3000K 30°

h(m)	E(lx)	D(m)
0.5	1805	0.30
1.0	451	0.59
1.5	201	0.89
2.0	113	1.18
2.5	72	1.48
3.0	50	1.78

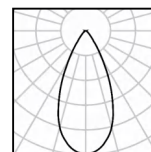

8W Ra92 3000K 50°

h(m)	E(lx)	D(m)
0.5	795	0.49
1.0	199	0.97
1.5	88	1.46
2.0	50	1.94
2.5	32	2.43
3.0	22	2.91



W system	lm system	optics	code
8W	388-385	20°- 50°	SF3808W-30N2050-B

MOOD

Φ55 Outdoor Downlight



view on website



cutout :55mm



Fixed Optic

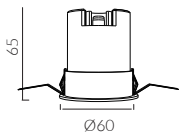

IP Rating:	IP65
Optics:	10°/24°/36°
UGR:	<10
CRI:	92Ra with 97Ra option
Lifetime:	>50,000 hrs (L70 B10)
CCT:	3000K
Typical Source	
Efficacy (lm/W):	113
Control:	On/off, Mains Dim, 0/1-10V, Dali, Zigbee, Casambi
Binning	2 Step MacAdams
Input:	AC220-240V 50/60Hz
Output:	DC 36V 200mA 8W
Ambient temp:	-20 °C to 45 °C
Class:	II
Optional accessories:	Honeycomb louvre, Solite Lense, Spread Lense, Colour Filter

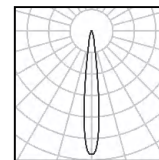

8W Ra92 3000K 10°

h(m)	E(lx)	D(m)
0,5	7812	0.10
1.0	1953	0.20
1.5	868	0.30
2.0	488	0.40
2.5	312	0.50
3.0	217	0.60

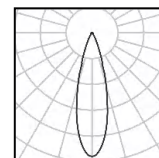

8W Ra92 3000K 24°

h(m)	E(lx)	D(m)
0.5	4392	0.21
1.0	1098	0.43
1.5	488	0.64
2.0	274	0.85
2.5	176	1.06
3.0	122	1.28

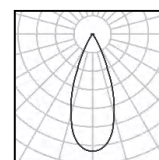

8W Ra92 3000K 36°

h(m)	E(lx)	D(m)
0.5	2345	0.32
1.0	586	0.64
1.5	261	0.96
2.0	147	1.28
2.5	94	1.61
3.0	65	1.93



W system	lm system	optics	code
8W	384	10°	WFL5508W-30N10
8W	501	24°	WFL5508W-30N24
8W	517	36°	WFL5508W-30N36

DOME

Outdoor Bollard Light



view on website

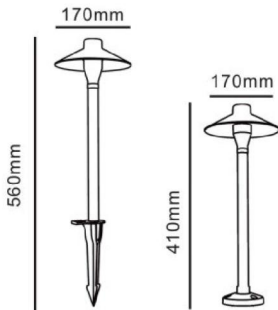
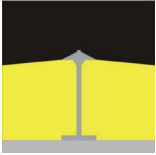

Matt Brown

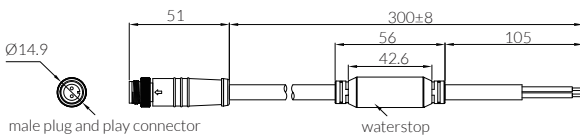

IP Rating:	IP65
UGR:	< 19
CRI:	92Ra
Lifetime:	>50,000 hrs (L70 B10)
CCT:	3000K
Typical Source	
Efficacy (lm/W):	113
Control:	On/off
Binning	2 Step MacAdams
Voltage:	DC24V
Power(W):	4W
Ambient temp:	-20 °C to 45 °C
Class:	III
Plug Type:	Plug & Play (2 pin) - male



W system	lm system	Input volatge	code
4W	240Lm	DC24V	SP1704

STICK

Outdoor 2 Spot Bollard Light



view on website



Adjustable Optic

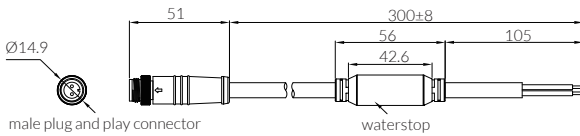
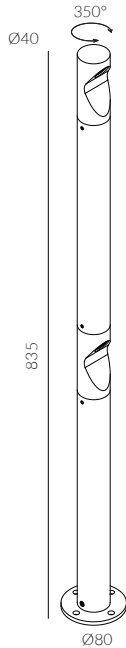

IP Rating:	IP65
Optics:	/
UGR:	<17
CRI:	92Ra
Lifetime:	>50,000 hrs (L70 B10)
CCT:	3000K
Typical Source	
Efficacy (lm/W):	113
Control:	On/off, Mains Dim, 0/1-10V, Dali, Zigbee, Casambi
Binning	2 Step MacAdams
Voltage:	DC 24V
Power(W):	5.2W
Ambient temp:	-40 C to 40 C
Class:	III
Plug Type:	Plug & Play (2 pin) - male



W system	lm system	code
5.2W	60	SBG1653-02-5W

ACME

Φ53

Outdoor Wall Light



view on website



Fixed Optic

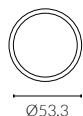
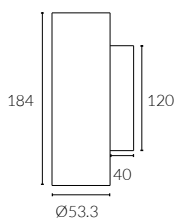

- IP Rating:** IP65
- Optics:** 15°/24°/36°
- UGR:** <10
- CRI:** 98Ra
- Lifetime:** >50,000 hrs (L70 B10)
- CCT:** 3000K
- Typical Source**
- Efficacy (lm/W):** 110
- Control:** On/off, Mains Dim, 0/1-10V, Dali, Zigbee, Casambi
- Binning** 2 Step MacAdams
- Input:** AC220-240V 50/60Hz
- Output:** DC 36V 200mA 8Wx2
- Ambient temp:** -20 °C to 45 °C
- Class:** II
- Optional accessories:** Honeycomb louvre, Solite Lense, Spread Lense, Colour Filter
- Material:** Fine aluminium 6063A

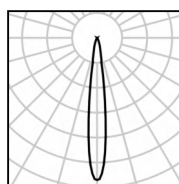

8W Ra98 3000K 15°

h(m)	E(lx)	D(m)
0.5	9800	0.15
1.0	2450	0.30
1.5	1089	0.45
2.0	613	0.60
2.5	392	0.76
3.0	272	0.91

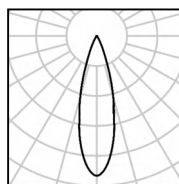

8W Ra98 3000K 24°

h(m)	E(lx)	D(m)
0.5	4501	0.20
1.0	1125	0.40
1.5	500	0.60
2.0	281	0.80
2.5	180	1.00
3.0	125	1.20

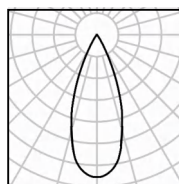

8W Ra98 3000K 36°

h(m)	E(lx)	D(m)
0.5	2744	0.27
1.0	686	0.55
1.5	305	0.82
2.0	172	1.09
2.5	110	1.37
3.0	76	1.64

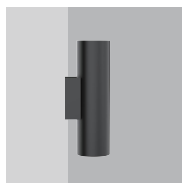
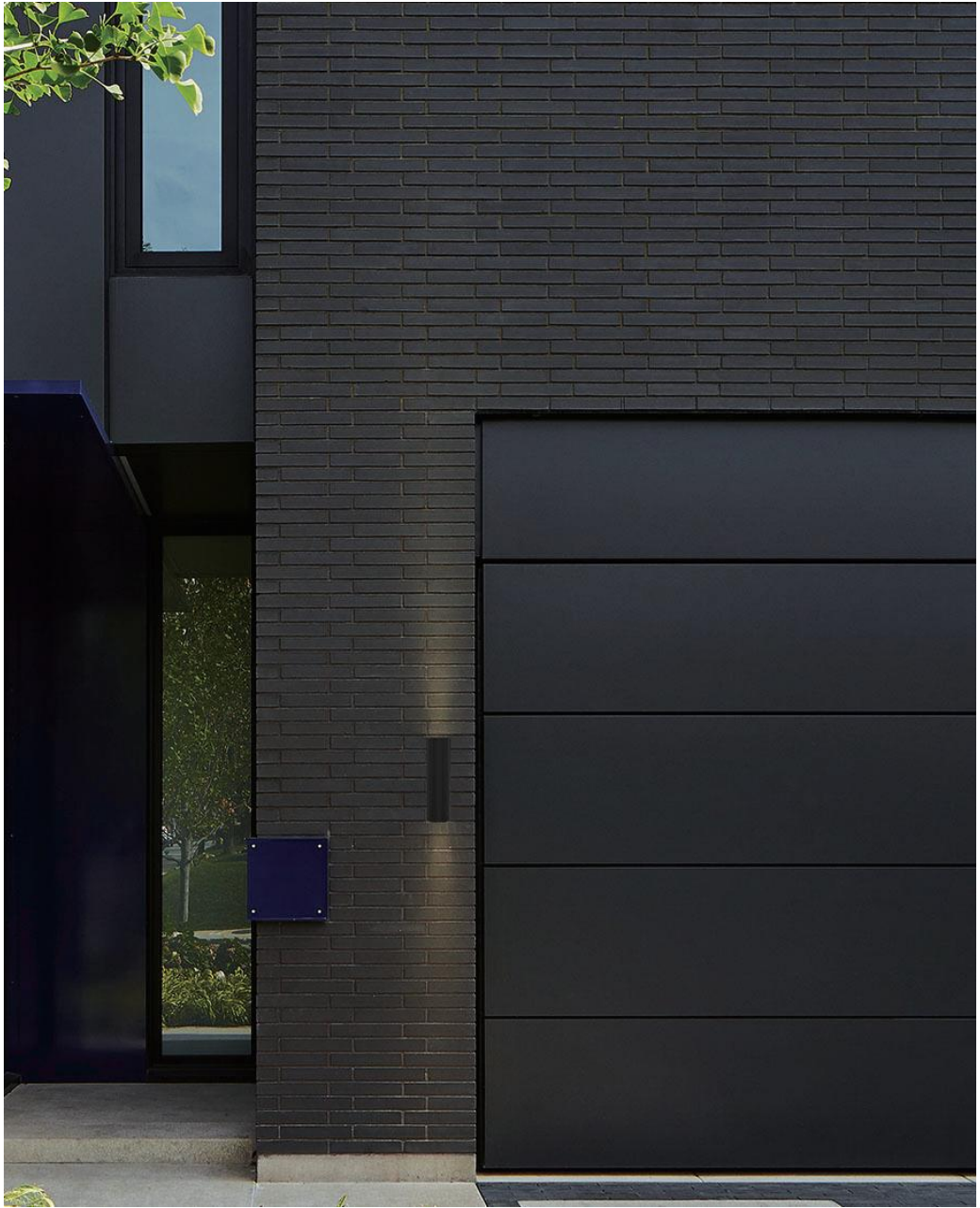

W system	Im system	optics	code
8Wx2	419x2	15°	OWE5708W-30N15-B
8Wx2	470x2	24°	OWE5708W-30N24-B
8Wx2	456x2	36°	OWE5708W-30N36-B

75 X 75 Outdoor Wall Light



Fixed Optic

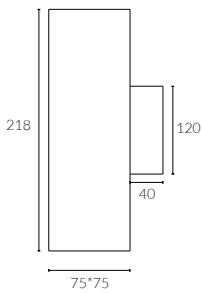

Black Painted

- IP Rating:** IP65
- Optics:** 15°/24°/36°/50°
- UGR:** <10
- CRI:** 98Ra
- Lifetime:** >50,000 hrs (L70 B10)
- CCT:** 3000K
- Typical Source**
- Efficacy (lm/W):** 110
- Control:** On/off, Mains Dim, 0/1-10V, Dali, Zigbee, Casambi
- Binning** 2 Step MacAdams
- Input:** AC220-240V 50/60Hz
- Output:** DC 36V 250mA 10Wx2
- Ambient temp:** -20 C to 45 C
- Class:** II
- Optional accessories:** Honeycomb louvre, Solite Lense, Spread Lense, Colour Filter
- Material:** Fine aluminium 6063A

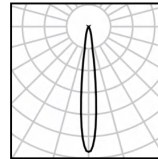

10W Ra98 3000K 15°

h(m)	E(lx)	D(m)
0.5	11475	0.15
1.0	2869	0.30
1.5	1275	0.45
2.0	717	0.60
2.5	459	0.76
3.0	319	0.91

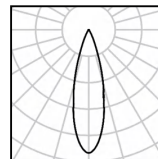

10W Ra98 3000K 24°

h(m)	E(lx)	D(m)
0.5	6198	0.22
1.0	1550	0.44
1.5	689	0.67
2.0	387	0.89
2.5	248	1.11
3.0	172	1.33

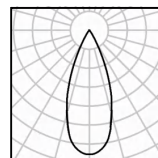

10W Ra98 3000K 36°

h(m)	E(lx)	D(m)
0.5	3390	0.31
1.0	847	0.62
1.5	377	0.92
2.0	212	1.23
2.5	136	1.54
3.0	94	1.85

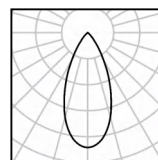

10W Ra98 3000K 50°

h(m)	E(lx)	D(m)
0.5	1133	0.49
1.0	283	0.98
1.5	126	1.47
2.0	71	1.96
2.5	45	2.45
3.0	31	2.94



W system	lm system	optics	code
10Wx2	553x2	15°	OWQE6810Wx2-30N15-B
10Wx2	575x2	24°	OWQE6810Wx2-30N24-B
10Wx2	565x2	36°	OWQE6810Wx2-30N36-B
10Wx2	485x2	50°	OWQE6810Wx2-30N50-B

WASHFLEX

DISCONTINUED

Outdoor Linear Wall Grazer



Fixed Optic

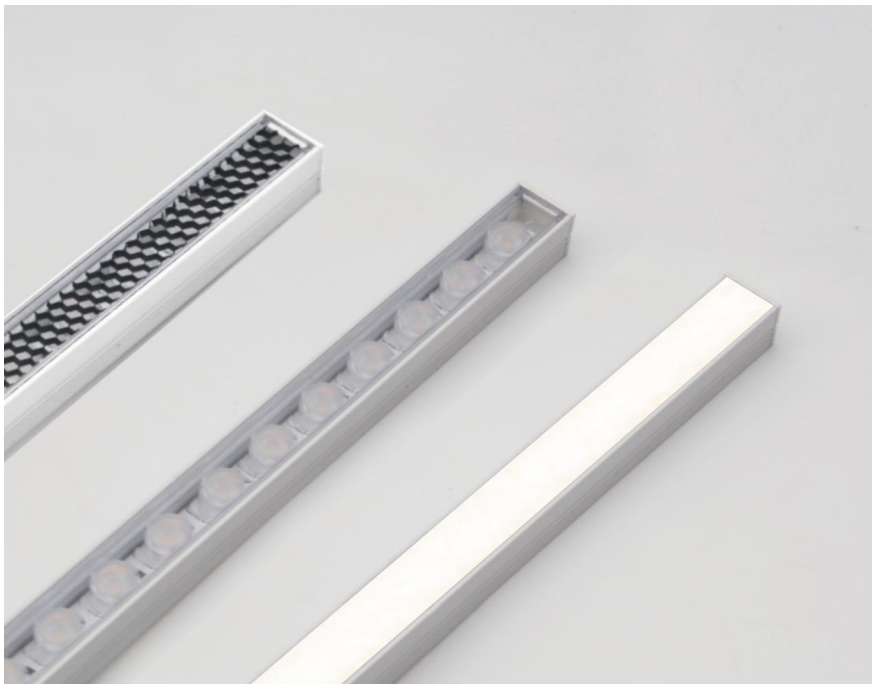
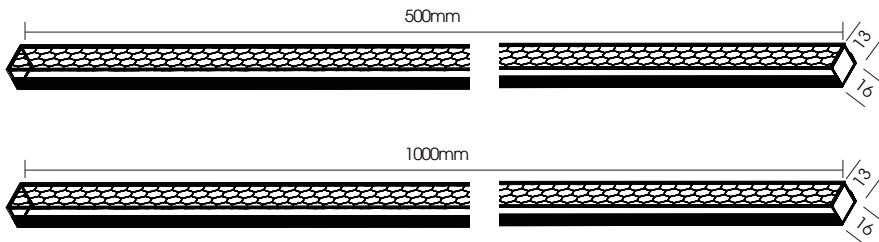

Accessories not included

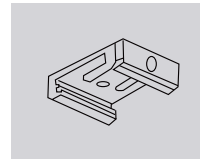

FC-flat clip

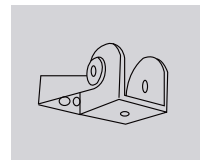

AC-adjustable clip

IP Rating:	IP67
IK:	06
Optics:	15° / 20° / 30° / 20°*45° / 120°
CRI:	>80Ra
Lifetime:	>50,000 hrs (L70 B10)
CCT:	3000K / RGB
Typical Source Efficacy (lm/W):	113
Control:	On/off, Mains Dim, 0/1-10V, Dali, Zigbee, Casambi
Binning:	2 Step MacAdams
Voltage:	DC 24V
Power(W):	9W / 18W
Ambient temp:	-20 °C to 45 °C
Class:	III



W system	lm system	length	optics	code
9W	521Lm	500mm	15°	LS1613TJ-9W-15
9W	534Lm	500mm	20°	LS1613TJ-9W-20
9W	562Lm	500mm	30°	LS1613TJ-9W-30
9W	503Lm	500mm	20° *45°	LS1613TJ-9W-2045



W system	lm system	length	optics	code
18W	1045Lm	1000mm	15°	LS1613TJ-18W-15
18W	1070Lm	1000mm	20°	LS1613TJ-18W-20
18W	1132Lm	1000mm	30°	LS1613TJ-18W-30
18W	1022Lm	1000mm	20° *45°	LS1613TJ-18W-2045



W system	lm system	length	optics	code
9W	650Lm	1000mm	120°	LSM1613TJ-9W-120

WASHFLEX

Outdoor Linear Wall Grazer



view on website



Fixed Optic

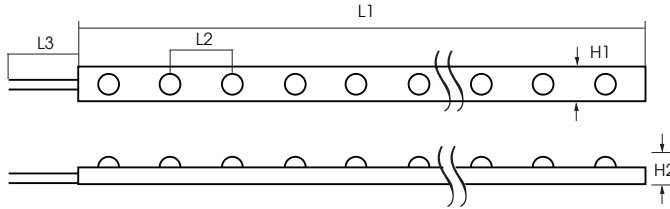

L1(mm)	5020	L2(mm)	41.7
L3(mm)	328		
H1(mm)	19.5	H2(mm)	10

Accessories not included

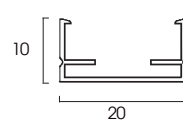

CHY-1
aluminium profile

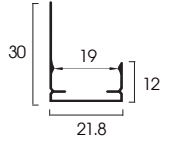

CHY-2
aluminium profile
with glare shield

IP Rating:	IP67
Optics:	15°/30°/25°/45°
CRI:	>80Ra
Lifetime:	>50,000 hrs (L70 B10)
CCT:	2200K/2700K/3000K/3500K/4000K/5000K
LEDs/M:	24pcs
Typical Source Efficacy (lm/W):	113
Control:	On/off, Mains Dim, 0/1-10V, Dali, Zigbee, Casambi
Binning:	2 Step MacAdams
Voltage:	DC 24V
Power(W):	18W/m
Ambient temp:	-20 °C to 45 °C
Class:	III

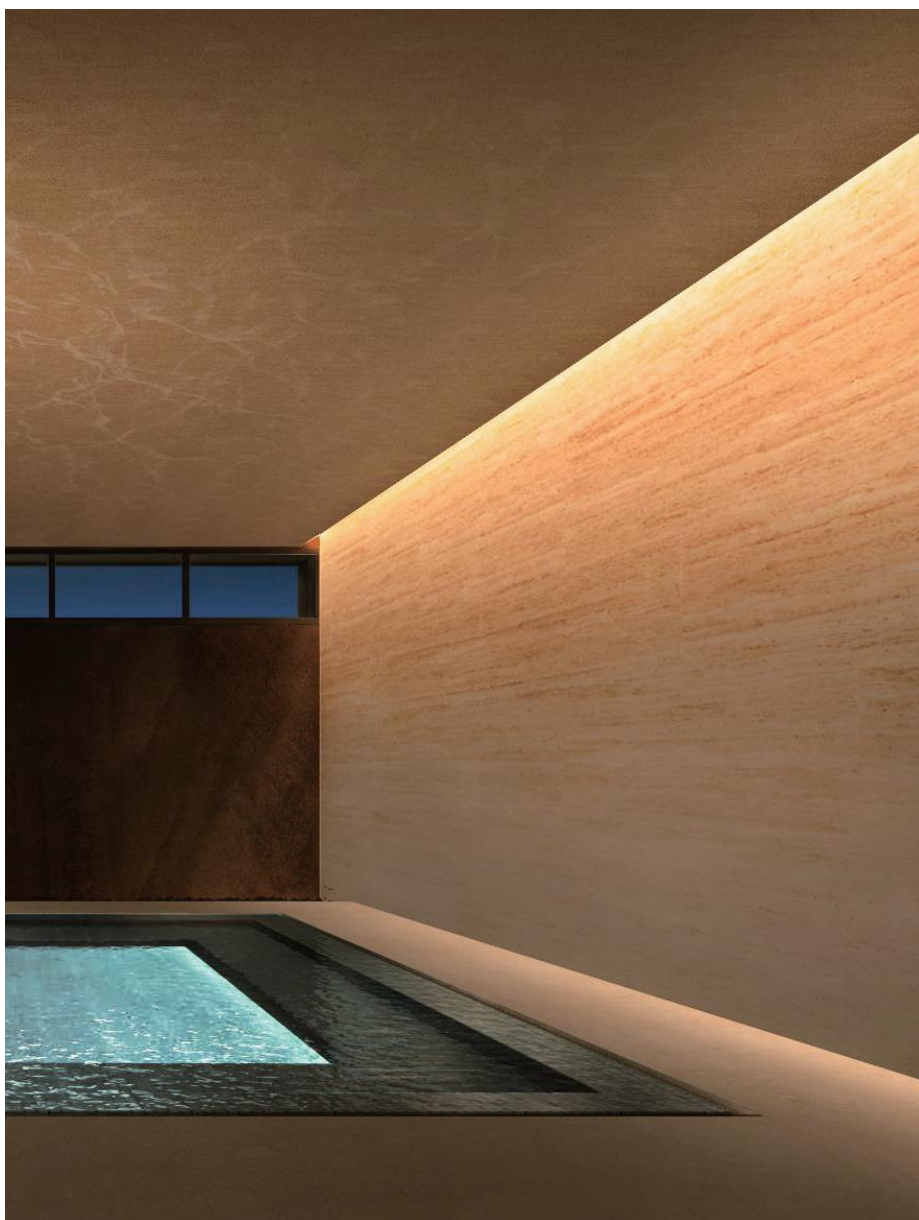

W system	lm system	optics	code
18W	75Lm/W	15°	CYH201024-18W-15
18W	88Lm/W	30°	CYH201024-18W-30
18W	77Lm/W	25*45°	CYH201024-18W-2545

WASHFLEX

Outdoor Linear Wall Grazer



view on website



Fixed Optic

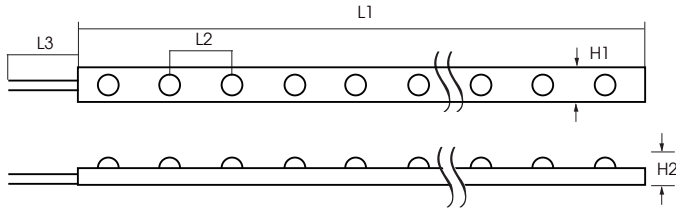

L1(mm)	5015	L2(mm)	35.7
L3(mm)	328		
H1(mm)	19.5	H2(mm)	10

Accessories not included

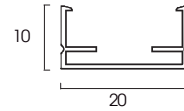

CHY-1
aluminium profile

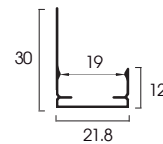

CHY-2
aluminium profile
with glare shield

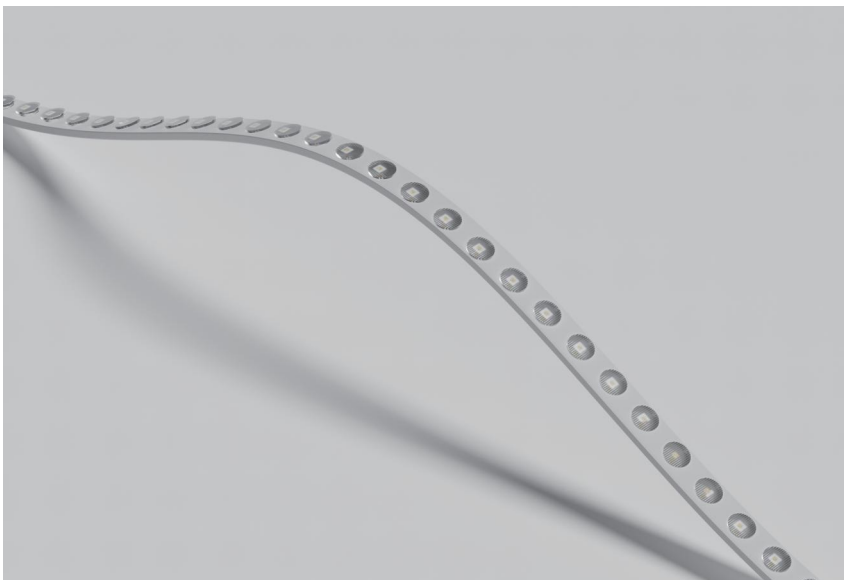

IP Rating:	IP67
Optics:	15°/30°/25°/45°
CRI:	>80Ra
Lifetime:	>50,000 hrs (L70 B10)
CCT:	RGBW
LEDS/M:	28pcs
Control:	On/off, Mains Dim, 0/1-10V, Dali, Zigbee, Casambi
Binning	2 Step MacAdams
Voltage:	DC 24V
Power(W):	18W/m,24W/m
Ambient temp:	-20 °C to 45 °C
Class:	III



W system	lm system	optics	code
R=4W	35Lm/W	25*45°	CYH201028-24W-2545-RGBW
G=4.1W	67Lm/W		
B=4.3W	11Lm/W		
W=7.5W	96Lm/W		
CW=7.5W	96Lm/W		

Accessories

Link Cable 1m



TECHNICAL FEATURES

Code:	LC-001
Environmental	
Temperature:	-40~105 C
Relative humidity:	90%+40 C
Voltage Rating:	125-250V AC,DC
Current rating:	8A
Contact resistance:	≤0.1Ω
Insulation resistance:	≥100MΩ
Resist-Electric strength:	500V AC/min
Waterproof Level:	IP 67

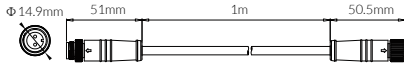

Link Cable 2m



TECHNICAL FEATURES

Code:	LC-002
Environmental	
Temperature:	-40~105 C
Relative humidity:	90%+40 C
Voltage Rating:	125-250V AC,DC
Current rating:	8A
Contact resistance:	≤0.1Ω
Insulation resistance:	≥100MΩ
Resist-Electric strength:	500V AC/min
Waterproof Level:	IP 67

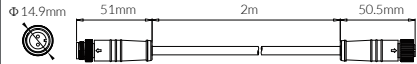

Link Cable 5m



TECHNICAL FEATURES

Code:	LC-005
Environmental	
Temperature:	-40~105 C
Relative humidity:	90%+40 C
Voltage Rating:	125-250V AC,DC
Current rating:	8A
Contact resistance:	≤0.1Ω
Insulation resistance:	≥100MΩ
Resist-Electric strength:	500V AC/min
Waterproof Level:	IP 67

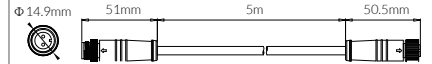

Link Cable 10m



TECHNICAL FEATURES

Code:	LC-010
Environmental	
Temperature:	-40~105 C
Relative humidity:	90%+40 C
Voltage Rating:	125-250V AC,DC
Current rating:	8A
Contact resistance:	≤0.1Ω
Insulation resistance:	≥100MΩ
Resist-Electric strength:	500V AC/min
Waterproof Level:	IP 67

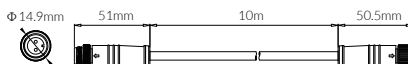

3 Way Cable Splitter



TECHNICAL FEATURES

Code:	Y02-1-3+M12C-2P
Environmental	
Temperature:	-40~105 C
Voltage Rating:	125V DC
Current rating:	8A
Contact resistance:	≤10mΩ
High Voltage Resistance:	3KV
Insulation resistance:	≥500 MΩat DC500V
Waterproof Level:	IP 67

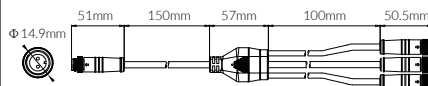

5 Way Cable Splitter



TECHNICAL FEATURES

Code:	Y02-1-5+M12C-2P
Environmental	
Temperature:	-40~105 C
Voltage Rating:	125V DC
Current rating:	8A
Contact resistance:	≤10mΩ
High Voltage Resistance:	3KV
Insulation resistance:	≥500 MΩat DC500V
Waterproof Level:	IP 67

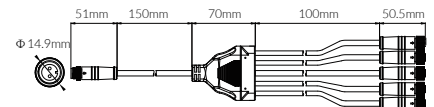

CONTROL

DURASMART ZIGBEE / CASAMBI / DRIVERS

DURA SMART+

Wireless smart lighting control system designed to be user-friendly,
easy to install, and cost-effective



Zigbee

DG.SMART is a wireless smart lighting control system designed to be user-friendly, easy to install, and cost-effective. This home automation solution allows you to easily create rules for how you want your devices to function. DuraGreen Zigbee system's state-of-the-art keypads make it simple to set up smart scenes. With the ability to control luminaires with just a swipe of your app, the DG.SMART system provides an exceptional user experience that makes the hectic pace of modern life slightly simpler.

DG.SMART ZIGBEE LED drivers and sensors are also compatible with popular Zigbee gateways on the market, such as Philips Hue, Tuya, Homey, Hubitat, Smarthings, and more.

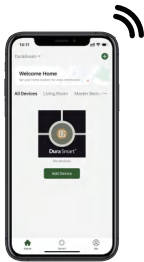

Microwave Sensor + Light Sensor



Constant Current
Zigbee LED Driver



Constant Voltage
24V Zigbee LED Driver



Constant Voltage
48V Zigbee LED Driver

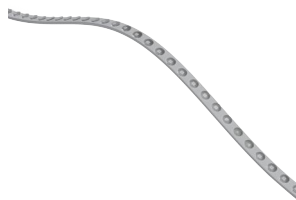

	SRP-ZG9105N -15CC100-700	CONSTANT CURRENT LED DRIVER Zigbee 1CH Max. 700mA
	SRP-ZG9105N -15CCT100-700	CONSTANT CURRENT LED DRIVER Zigbee 2CH Max. 700mA
	SRP-ZG9105-24 -100LCV	CONSTANT VOLTAGE LED DRIVER Zigbee 1CH 24VDC 100W
	SRP-ZG9105-24 -150LCV	CONSTANT VOLTAGE LED DRIVER Zigbee 1CH 24VDC 150W
	SRP-ZG9105-MT -48CC	CONSTANT VOLTAGE LED DRIVER Zigbee 1CH 48VDC 30W
	SRP-ZG9105-24 -100LCVT	CONSTANT VOLTAGE LED DRIVER Zigbee 2CH 24VDC 100W
	SRP-ZG9105-24 -150LCVT	CONSTANT VOLTAGE LED DRIVER Zigbee 2CH 24VDC 150W
	SRP-ZG9105-MT -48CCT	CONSTANT VOLTAGE LED DRIVER Zigbee 2CH 48VDC 30W
	SRP-ZG9105-24 -100LCVF	CONSTANT VOLTAGE LED DRIVER Zigbee 4CH 24VDC 100W
	SRP-ZG9105-24 -150LCVF	CONSTANT VOLTAGE LED DRIVER Zigbee 4CH 24VDC 150W
	A4TWG-ZB	DG.SMART Zigbee Gateway Hub Wireless Zigbee smart control
	A1T2826A-ZB	ZIGBEE 6 Button Wall Plate Wireless Zigbee smart control
	AF50-ZG-MW	Microwave Sensor + Light Sensor

CASAMBI

Casambi is a Bluetooth low energy-based technology that enables devices to be wireless connected and controlled to create customizable lighting networks. Casambi provides smart lighting control through intuitive applications that establish new standards in user interaction with light. It is an ideal option for projects where the wiring is already in place, as these products can be easily installed alongside existing wiring circuits.

In just one decade, Casambi has become a global leader with over 300 ecosystem partners and has sold over 5 million devices for use in over 200,000 lighting projects worldwide.

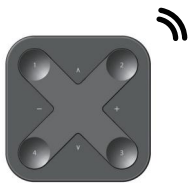

Dimming Wireless WallSwitch



Microwave Sensor + Light Sensor



Constant Current
Casambi LED Driver



Constant Voltage
Dimming Wireless Control
Unit

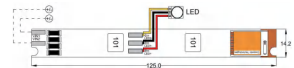

Constant Voltage
48V Casambi LED Driver

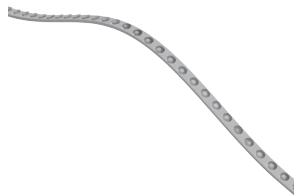



127630

CONSTANT CURRENT LED DRIVER
Casambi 1CH
Max. 1050mA



40/300-1050

CONSTANT CURRENT LED DRIVER
Casambi 1CH
Max. 1050mA

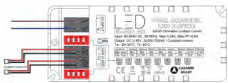

Bi-Dim-Cas-AC

CONSTANT CURRENT LED DRIVER
Casambi 2CH
Max. 700mA

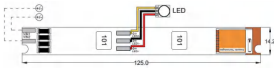

EC01

CONSTANT VOLTAGE LED DRIVER
Casambi 1 or 2 CH
48VDC 25W



CBU-PWM4

Constant Voltage
Dimming Wireless Control Unit
12-24VDC



CBU-ASD

Compact Bluetooth 0-10V/1-10V/DALI Dimming
Wireless Control Unit



SR-2421-CS

CASAMBI to DALI+0-10V+Relay
Tandalone, 50mA DALI current output+20mA 0-10V+5A relay



AF50-CA-MW

Microwave motion sensor+light sensor+0-10V/DALI output
Motion detection+lux detection+0-10V/DALI dimming output



AF50-CA-MV

PIR motion sensor+light sensor+0-10V/DALI output
Motion detection+lux detection+0-10V/DALI dimming output





X-Press

Dimming Wireless WallSwitch









DRIVERS

CONSTANT CURRENT LED DRIVER ON-OFF

ON-OFF	Code	P out W	V out DC	I out DC	Dimensions
	XGL007C0250 SLEW-A7-12	2.5÷10W	25...40V	100...250mA via dip switch	80x40x22mm
	XGL015C0350 SLEW-A7-12	6.3÷14W	25...40V	250...350mA via dip switch	80x40x22mm
	XGL007C0700 HGAW-A7-12	2.4÷8.4W	6...12V	400...700mA via dip switch	80x40x22mm
	XGL030C0600 HGAW-A8-02	12÷30W	30...50V	400...600mA via dip switch	100x40x25mm
	127570	3÷22W	5...44V	125...500mA via dip switch	108x43.5x22mm
	127571	3÷22W	5...44V	125...500mA via dip switch	88x42.5x21.5mm
	21/350-500	10.5÷21W	30...42V	350...500mA via dip switch	169.5x45.8x32mm
	31/550-750	16.5 ÷ 31.5 W	30...42V	550...750mA via dip switch	169.5x45.8x32mm

DRIVERS

CONSTANT CURRENT LED DRIVER DIM

PHASE CUT	Code	P out W	V out DC	I out DC	Dimensions
	GC2896	4÷12.6W	25...42V	150...300mA via dip switch	128×29×20mm
	SE-12-100 -400-G1T	1÷12W	9...42V	100...400mA via dip switch	111×35×20mm
	TD-10-100 -450-G1T	1÷10W	9...42V	100...450mA via dip switch	135×30×20mm
	OT FIT 14/220 - 240/350 CS PC	5.4÷14W	27...40V	200...350mA via dip switch	130×30×22.2mm
0-10V					
	GC6888-0-10V	1.4÷12W	9...42V	150...300mA via dip switch	128×29×20mm
	SE-12-100- 450-W2A	1÷12W	9...42V	100...450mA via dip switch	111×35×20mm
	IT DIM 12/220- 240/300 CS I	2.3÷12.6W	23...42V	70...300mA via dip switch	130×30×20mm
Zigbee 1CH					
	SRP-ZG9105N -15CC100-700	0.6÷15W	6...42V	100...700mA via NFC	135×35×20mm
Zigbee 2CH					
	SRP-ZG9105N -15CCT100-700	0.6÷15W	6...42V	100...700mA via NFC	135×35×20mm



DRIVERS

CONSTANT CURRENT LED DRIVER DIM

DALIDT6	Code	P out W	V out DC	I out DC	Dimensions
	GC6888-DALI	1.4÷12W	9...42V	150...300mA via dip switch	129×28×20mm
	SRP-2305N- 15CC100-700	0.6÷15W	6...42V	100...700mA via NFC	135×35×20mm
	SRP-2305N- 25CC250-700	1.2÷25W	6...54V	250...700mA via NFC	120×41×28mm
	SRP-2305N- 45CC500-1400	3÷45W	6...54V	500...1400mA via NFC	145×45×28mm
	SE-12-100-400 -W1DS	1÷12W	9...42V	100...400mA via dip switch	135×30×20mm
	127600	1.5÷22W	10...44V	125...500mA via dip switch	146.5×43.5×22mm
	40/300-1050 DALI	1.5÷40W	5...42V	300...1050mA via dip switch	260×32×42.5mm
DALI DT8					
	SRP-2309N- 15CCT100-700	0.6÷15W	6...42V	100...700mA via NFC	135×35×20mm
	SE-12-100-450 -W2D	1÷12W	9...42V	100...450mA via dip switch	111×35×20mm

DRIVERS

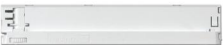
CONSTANT CURRENT LED DRIVER DIM









CASAMBI 1 CH	Code	P out W	V out DC	I out DC	Dimensions
	127630	1÷38W	10...54V	300...1050mA via dip switch	146.5×44×30mm
	40/300-1050	5÷40W	19...54V	300...1050mA via dip switch	234×32×43mm
CASAMBI 2 CH					
	Bi-Dim-Cas-AC	1÷25W	2...50V	200...700mA via dip switch	160×67×30mm

CONSTANT VOLTAGE LED DRIVER ON-OFF

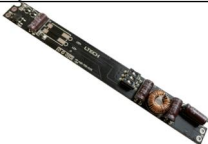
ON-OFF	Code	P (MAX)	V	Dimensions
	XGL060V0240 SGAW-X15-00	60W	24VDC	165×30×20mm
	XGL100V0240 SGAW-X15-00	100W	24VDC	240×30×20mm
	XGL150V0240 SGAW-X14-00	150W	24VDC	302×30×20mm
CASAMBI 1 or 2 CH	Code	P (MAX)	V	Dimensions
	EC01	25W	48VDC	125×14.2×10mm

DRIVERS

CONSTANT VOLTAGE LED DRIVER DIM

DALI DT6 1CH	Code	P (MAX)	V	Dimensions
	LM-100-24-G1D2	100W	24VDC	293×43×30mm
	LM-150-24-G1D2	150W	24VDC	352×43×30mm
	MT-100-400-D1D	12W	48VDC	125×14×10mm
DALI DT8 2CH				
	LM-100-24-G2D2	100W	24VDC	293×43×30mm
	LM-150-12-G2D2	150W	24VDC	352×43×30mm
	MT-100-250-D2D1	12W	48VDC	125×14×10mm
DALI DT8 4CH				
	SRP-2309-24-100LCVF	100W	24VDC	306.6×43×30mm
	SRP-2309-24-150LCVF	150W	24VDC	365.6×43×30mm

DRIVERS

CONSTANT VOLTAGE LED DRIVER DIM

Zibgee 1CH	Code	P (MAX)	V	Dimensions
	SRP-ZG9105-24-100LCV	100W	24VDC	306.6×43×30mm
	SRP-ZG9105-24-150LCV	150W	24VDC	365.6×43×30mm
	SRP-ZG9105-MT-48CC	30W	48VDC	125×14.2mm
Zibgee 2CH				
	SRP-ZG9105-24-100LCVT	100W	24VDC	306.6×43×30mm
	SRP-ZG9105-24-150LCVT	150W	24VDC	365.6×43×30mm
	SRP-ZG9105-MT-48CCT	30W	48VDC	125×14.2mm
Zibgee 4CH				
	SRP-ZG9105-24-100LCVF	100W	24VDC	306.6×43×30mm
	SRP-ZG9105-24-150LCVF	150W	24VDC	365.6×43×30mm

Credits

Art Direction

Alexanda Studios

Graphic Design

Marka Studios

Proofread

Ariane L. Smith

Photo / Rendering

DuraGreen Team

Customer Service

United Kingdom

uk@duragreenlighting.co.uk
DuraGreen Distribution UK Ltd
Waldringfield Road
Ipswich
Suffolk

Europe

eu@duragreenlighting.co.uk
DuraGreen Lighting UK Ltd
9 Beech Street
Leicester
LE5 0DF

Middle East / Africa

dubai@duragreenlighting.co.uk
DuraGreen Dubai
Office 16C1, iRise Tower,
Barsha Heights
Dubai

Asia Pacific

shenzhen@duragreenlighting.co.uk
DuraGreen Lighting Shenzhen Ltd
A3 Building, Bao Ying Industrial Park
Long Gang
Shenzhen

Australasia

aus@duragreenlighting.co.uk
DuraGreen Australia Pty Ltd
159 Bunnerong RD
kingsford 2032
Australia

Vietnam / Laos / Cambodia

vietnam@duragreenlighting.co.uk
DuraGreen Vietnam Co. Ltd
#33, Sunrise H, The Manor Central Park
Nghiem Xuan Yem, Hoang Mai, Hanoi
Vietnam

The spec information provided in this catalogue aims to offer comprehensive insight into our light fixtures. It is important to note that, similar to all electronic devices, slight variations may occur in the delivered products. As a result, different outcomes may arise under conditions that differ from our testing parameters (such as extreme cold or heat). While the results presented here provide an indication of the product's anticipated performance, it is vital not to solely rely on them as a warranty of performance or as a suitability indicator. If any products do not meet expectations, please do not hesitate to contact us for further assistance.

