

ACME 48V

Φ50 Engine 48V Pendant

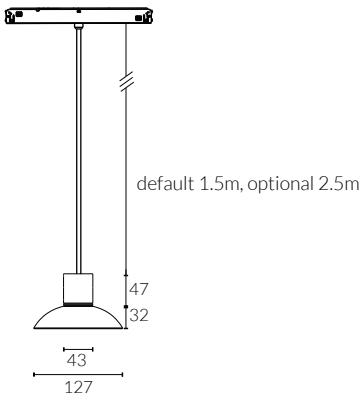

Fixed Optic



Engine



Black

Glass



Smoke Grey

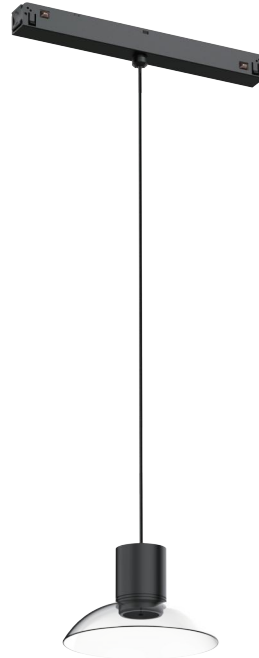

IP Rating:	IP20 and IP44 options
Optics:	15°/24°/36°
UGR:	<10
CRI:	98Ra
Lifetime:	>50,000 hrs (L70 B10)
CCT:	2700K/3000K/3500K/4000K/5000K/ 2000K-3000K/1800K-4000K/2700K-6000K
Typical Source	
Efficacy (lm/W):	110
Control:	On/off, 0/1-10V, Dali, Zigbee, Casambi
Binning	2 Step MacAdams
Input:	48 VDC
Output:	DC 36V 200mA 8W
Ambient temp:	-20 °C to 45 °C
Class:	III

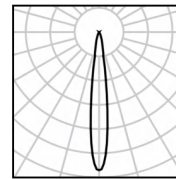

8W Ra98 3000K 15°

h(m)	E(lx)	D(m)
0.5	7204	0.11
1.0	1801	0.22
1.5	800	0.33
2.0	450	0.43
2.5	288	0.54
3.0	200	0.65

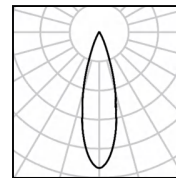

8W Ra98 3000K 24°

h(m)	E(lx)	D(m)
0.5	2613	0.25
1.0	653	0.49
1.5	290	0.74
2.0	163	0.99
2.5	105	1.24
3.0	73	1.48

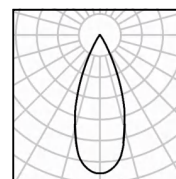

8W Ra98 3000K 36°

h(m)	E(lx)	D(m)
0.5	2005	0.34
1.0	501	0.68
1.5	223	1.03
2.0	125	1.37
2.5	80	1.71
3.0	56	2.05

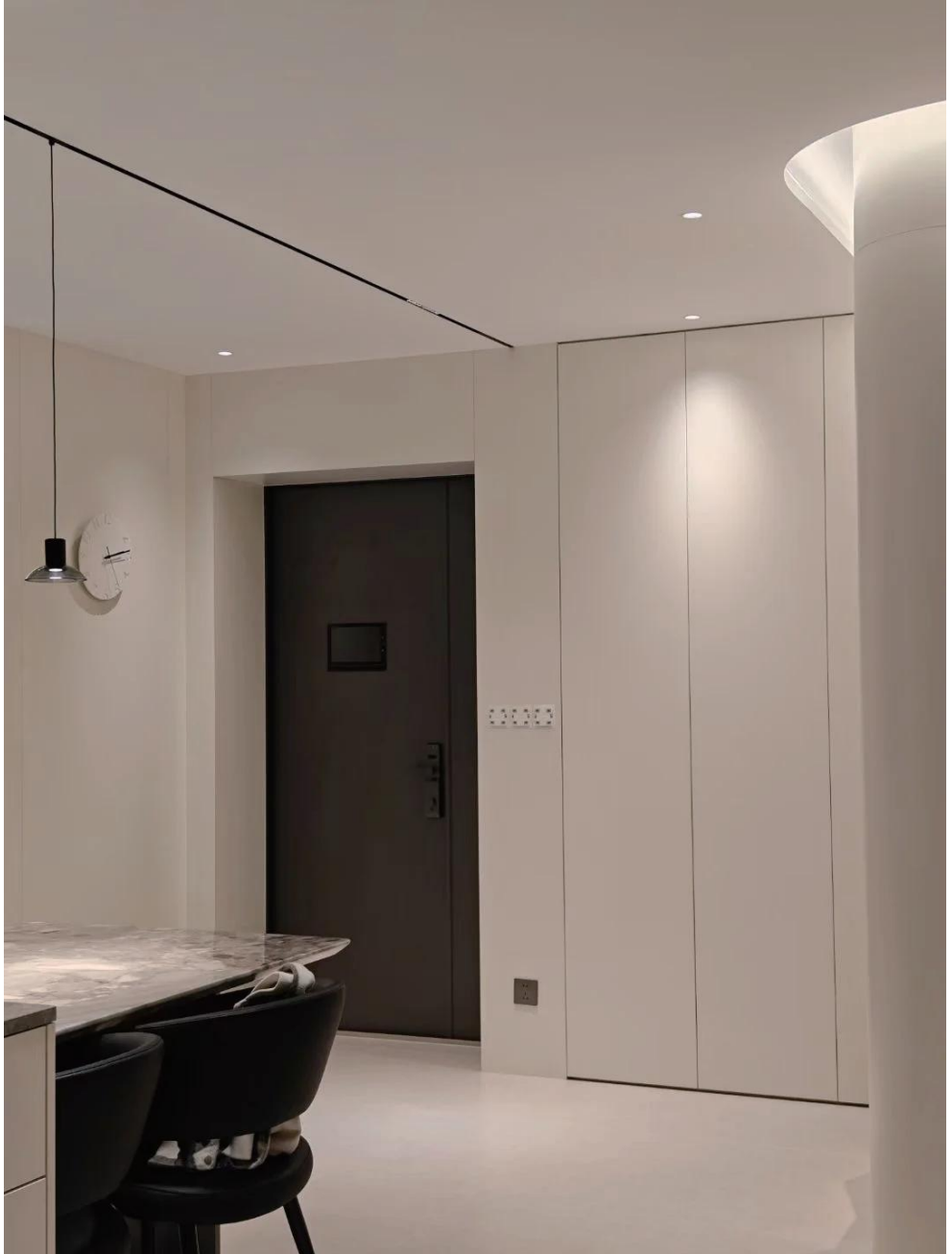

DuraGreen project:
Luxury Home

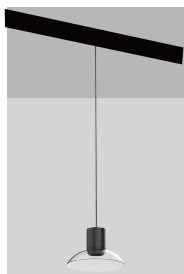

W system	lm system	optics	code
8W	336	15°	MPWGE5008W-30N15-B
8W	381	24°	MPWGE5008W-30N24-B
8W	453	36°	MPWGE5008W-30N36-B