

# ACME SEMI

## Φ50 Engine Semi-recessed Trimless Adjustable Round Downlight



cutout:50mm



Adjustable Optic

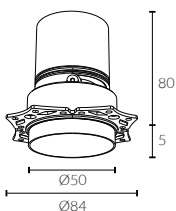
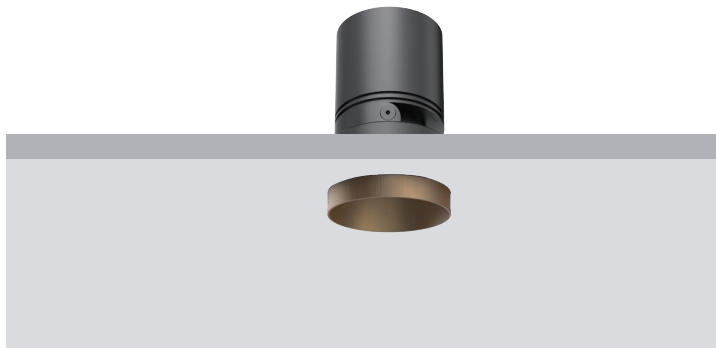

### Standard



Black Painted  
9005



White Painted  
9016

### Curated Finishes (MOQ 20 applies)



Polished Brass



Black Nickel



Bright Chrome



Rose Gold



Solid Brass



Peach Fuzz



Antique Copper



Aged Bronze



Antique Brass



Dark Brass



Brushed Grey



Pearl Nickel

<b>IP Rating:</b>	Front IP44, optional IP65
<b>Optics:</b>	15°/24°/36°
<b>UGR:</b>	< 10
<b>CRI:</b>	98Ra
<b>Lifetime:</b>	>50,000 hrs (L70 B10)
<b>CCT:</b>	2700K/3000K/3500K/4000K 1800-3000K(Warm Dim), 2700K - 6000K (Tunable White)

<b>Typical Source Efficacy (lm/W):</b>	110
<b>Control:</b>	On/off, Mains Dim, 0/1-10V, Dali, Zigbee, Casambi
<b>Binning</b>	2 Step MacAdams
<b>Input:</b>	AC220-240V 50/60Hz
<b>Output:</b>	DC 36V 100mA 4W DC 36V 150mA 6W DC 36V 200mA 8W

<b>Ambient temp:</b>	-20 °C to 45 °C
<b>Class:</b>	II
<b>Optional accessories:</b>	Honeycomb louvre, Solite Lense, Spread Lense, Colour Filter

<b>Material:</b>	Fine aluminium 6063A
<b>Fire resistance test:</b>	60 minutes

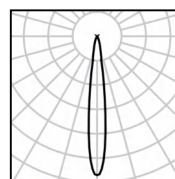

8W Ra98 3000K 15°

h(m)	E(lx)	D(m)
0.5	8156	0.16
1.0	2039	0.32
1.5	906	0.49
2.0	510	0.65
2.5	326	0.81
3.0	227	0.97

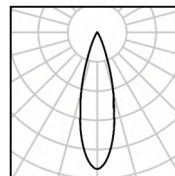

8W Ra98 3000K 24°

h(m)	E(lx)	D(m)
0.5	5690	0.20
1.0	1423	0.41
1.5	632	0.61
2.0	356	0.81
2.5	228	1.02
3.0	158	1.22

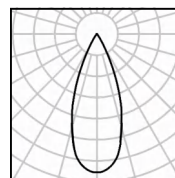

8W Ra98 3000K 36°

h(m)	E(lx)	D(m)
0.5	1882	0.33
1.0	470	0.66
1.5	209	0.99
2.0	118	1.32
2.5	75	1.64
3.0	52	1.97

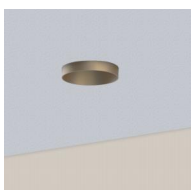
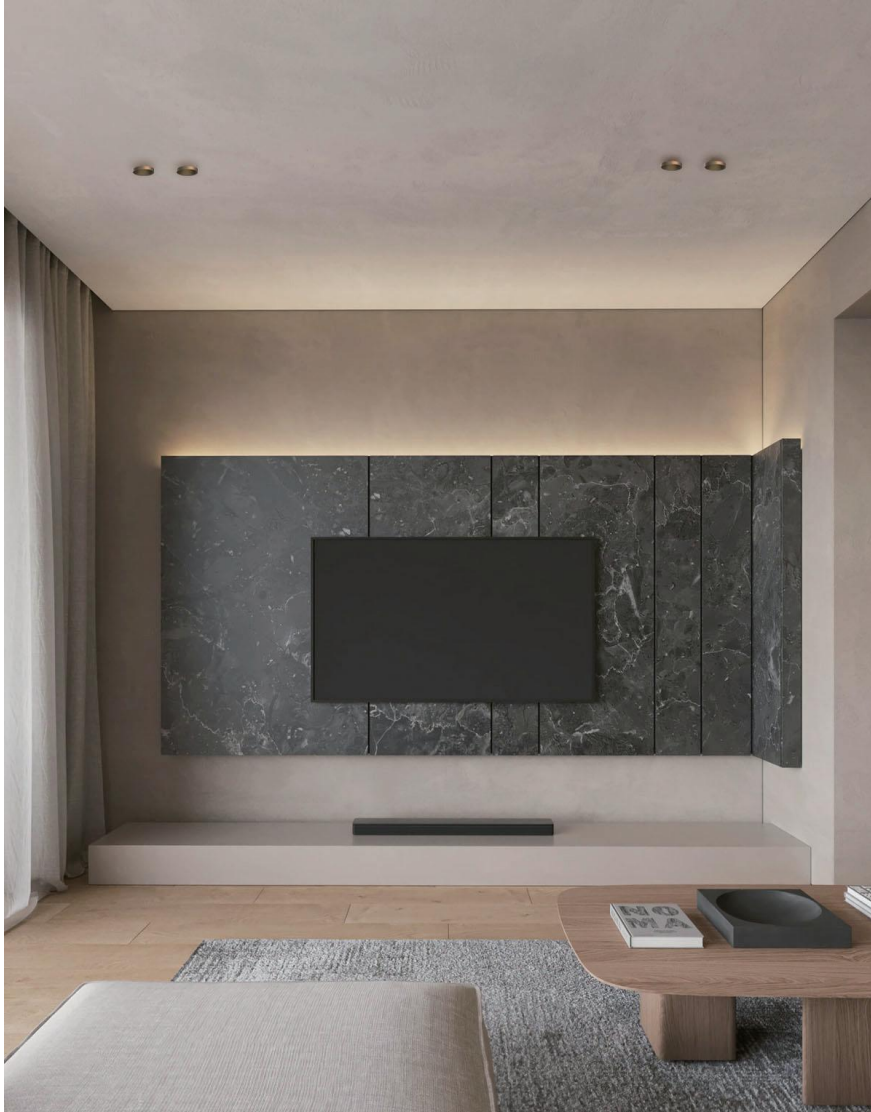

W System	Lm System	Optics	Code
4W	270	15°	AFL5004W-M-TL-30N15
4W	303	24°	AFL5004W-M-TL-30N24
4W	333	36°	AFL5004W-M-TL-30N36

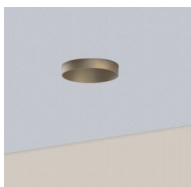

W System	Lm System	Optics	Code
6W	395	15°	AFL5006W-M-TL-30N15
6W	446	24°	AFL5006W-M-TL-30N24
6W	493	36°	AFL5006W-M-TL-30N36

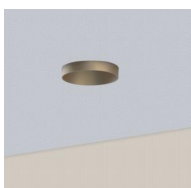

W System	Lm System	Optics	Code
8W	506	15°	AFL5008W-M-TL-30N15
8W	577	24°	AFL5008W-M-TL-30N24
8W	635	36°	AFL5008W-M-TL-30N36