

ACME SEMI

Φ78 Engine Semi-recessed Trimless Adjustable Round Downlight



cutout: 78mm



Adjustable Optic

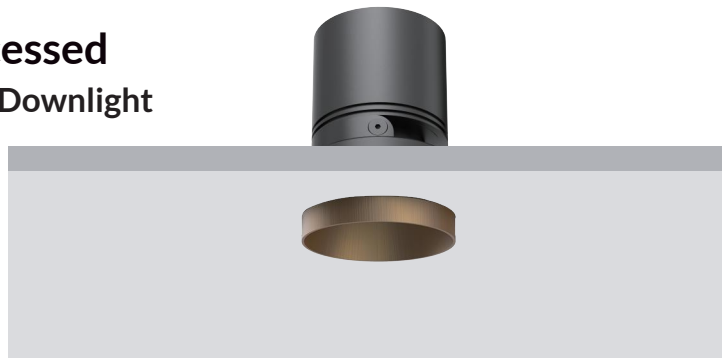
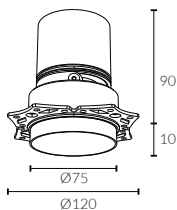

Standard



Black Painted
9005



White Painted
9016

Curated Finishes (MOQ 20 applies)



Polished Brass



Black Nickel



Bright Chrome



Rose Gold



Solid Brass



Peach Fuzz



Antique Copper



Aged Bronze



Antique Brass



Dark Brass



Brushed Grey



Pearl Nickel

IP Rating:	Front IP44, optional IP65
Optics:	15°/24°/36°/50°
UGR:	<10
CRI:	98Ra
Lifetime:	>50,000 hrs (L70 B10)
CCT:	2700K/3000K/3500K/4000K 1800-3000K(Warm Dim), 2700K - 6000K (Tunable White)
Typical Source Efficacy (lm/W):	110
Control:	On/off, Mains Dim, 0/1-10V, Dali, Zigbee, Casambi
Binning	2 Step MacAdams
Input:	AC 220-240V 50/60Hz
Output:	DC 36V 200mA 8W DC 36V 250mA 10W DC 36V 300mA 12W
Ambient temp:	-20 °C to 45 °C
Class:	II
Optional accessories:	Honeycomb louvre, Solite Lense, Spread Lense, Colour Filter
Material:	Fine aluminium 6063A
Fire resistance test:	60 minutes

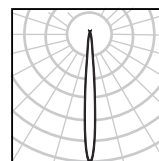

10W Ra98 3000K 5°

h(m)	E(lx)	D(m)
0.5	43452	0.05
1.0	10863	0.10
1.5	4828	0.15
2.0	2716	0.20
2.5	1738	0.24
3.0	1207	0.29

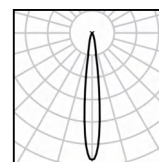

12W Ra98 3000K 15°

h(m)	E(lx)	D(m)
0.5	17662	0.13
1.0	4416	0.26
1.5	1962	0.39
2.0	1104	0.52
2.5	706	0.65
3.0	491	0.78

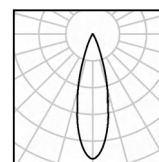

12W Ra98 3000K 24°

h(m)	E(lx)	D(m)
0.5	6966	0.22
1.0	1741	0.44
1.5	774	0.65
2.0	435	0.87
2.5	279	1.09
3.0	193	1.31

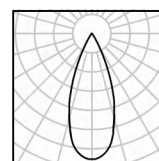

12W Ra98 3000K 36°

h(m)	E(lx)	D(m)
0.5	3324	0.32
1.0	831	0.64
1.5	369	0.96
2.0	208	1.28
2.5	133	1.61
3.0	92	1.93

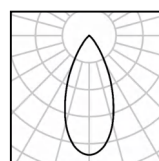

12W Ra98 3000K 50°

h(m)	E(lx)	D(m)
0.5	1826	0.48
1.0	456	0.95
1.5	203	1.43
2.0	114	1.91
2.5	73	2.38
3.0	51	2.86

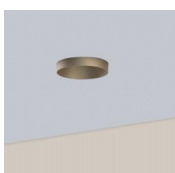

W system	lm system	optics	code
6W	186	5°	AFL7806W-M-TL-30N05

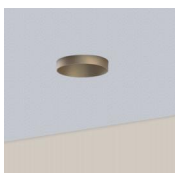

W system	lm system	optics	code
8W	255	5°	AFL7808W-M-TL-30N05
8W	573	15°	AFL7808W-M-TL-30N15
8W	548	24°	AFL7808W-M-TL-30N24
8W	519	36°	AFL7808W-M-TL-30N36
8W	600	50°	AFL7808W-M-TL-30N50

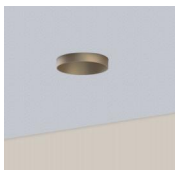

W system	lm system	optics	code
10W	276	5°	AFL7810W-M-TL-30N05
10W	699	15°	AFL7810W-M-TL-30N15
10W	666	24°	AFL7810W-M-TL-30N24
10W	624	36°	AFL7810W-M-TL-30N36
10W	726	50°	AFL7810W-M-TL-30N50

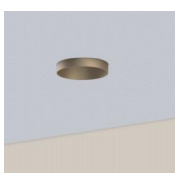

W system	lm system	optics	code
12W	822	15°	AFL7812W-M-TL-30N15
12W	790	24°	AFL7812W-M-TL-30N24
12W	780	36°	AFL7812W-M-TL-30N36
12W	841	50°	AFL7812W-M-TL-30N50